

HO.RE.CA.

20  
19

**abert**<sup>®</sup>

**abert<sup>®</sup>**

Abert nasce nel 1929 a Lumezzane, in provincia di Brescia: Antonio Bertoli dà inizio alla sua storia producendo artigianalmente posate in ottone. Negli anni '30 le materie prime utilizzate sono nichel e alluminio e nel 1950 l'acciaio entra stabilmente nei cicli di produzione, prendendo il posto di tutti gli altri materiali. Negli anni '60 verrà introdotta l'automatizzazione produttiva e nel 1975 Abert sarà la prima azienda al mondo ad ingegnerizzare i processi per la produzione di posate colorate con la combinazione di materiali come ABS, nylon e legno. Nel 1987 la sede si trasferisce a Passirano e nel 1993 acquisisce il marchio Facix e lo storico marchio milanese Broggi, leader di mercato nella posateria e nei complementi d'arredo per la tavola nel settore alberghiero. Nel 1994 è la prima azienda del settore ad ottenere la certificazione di qualità ISO 9002. Nel 2000 Abert cresce lanciando un nuovo progetto per il canale l'Ho.Re.Ca. con l'introduzione di una ampia gamma di prodotti professionali alberghieri.

Oggi, quasi novant'anni dopo la sua nascita, ancora guidata dalla famiglia Bertoli alla quarta generazione, Abert continua a puntare sull'innovazione, sulla qualità dei propri prodotti, sulla sensibilità e l'ascolto del cliente e sulla sua capacità di mutare insieme al mercato.

Abert pone da sempre al centro della propria attività valori che considera irrinunciabili: l'eccellenza delle materie prime, determinante per la performance dei propri prodotti, l'innovazione sulla base di processi produttivi e tecnologie d'avanguardia, la qualità dei prodotti che produce nei propri stabilimenti, a Passirano, il design che si traduce nella creazione di oggetti unici e che è alla base dello studio di ogni suo nuovo prodotto.

Per vincere le sfide del futuro Abert investe su se stessa e sui propri valori, che esprime con una forte cultura d'impresa ed azioni concrete, impegnandosi nella tutela e nella difesa dell'ambiente e nell'etica dei rapporti economici e sociali.

## STORIA • HISTORY

*Abert is founded in 1929 in Lumezzane, in the province of Brescia: Antonio Bertoli starts its story by manufacturing brass cutlery by hand. in the 30's the raw materials used are nickel and aluminium and in 1950 steel enters in the production cycles permanently, replacing all the other materials. in the '60s production automation is introduced and in 1975 Abert is the first company in the world to engineering the processes for the production of colored-handle cutlery with the combination of materials like ABS, nylon and wood. in 1987 the company headquarters move to Passirano and in 1993 Abert acquires the brand Facix and the historical Milanese brand Broggi, market leader in hotel cutlery and tableware. in 1994 it is the first company of the sector to achieve the quality certification ISO 9002. in 2000 Abert grows and launches a new project for the Ho.Re.Ca. channel with the introduction of a wide range of hotel professional products.*

*Today, almost ninety years after its birth, still led by the Bertoli family on its fourth generation, Abert goes on aiming at innovation, quality of its products, sensitivity and listening to its customers and on its capability of changing with the market.*

*Abert has always placed at the centre of its activities fundamental values: excellence of raw materials, crucial for the performance of its products, innovation on the base of production processes and state-of-the-art technologies, quality of the products it manufactures in its own factories in Passirano, design, that means creation of unique objects and which is the foundation of every new product.*

*in order to win the challenges of the future Abert invests on its own and on its values that expresses through a strong enterprise culture and concrete action, committing to protect and defend the environment and the ethics involved in economic and social relationships.*

**abert<sup>®</sup>**

CATALOGO HORECA 2019

## POSATE / FLATWARE 5

MODERN	12
CLASSIC	45
BASIC	64
COLOR	82
FINISHING	86

## ACCESSORI / ACCESSORIES 97

BREAK&FAST	98
COFFEE&DRINKS	100
TAPAS&APPETIZERS	104
PIZZA&STEAKS	106
MARISCOS&ESCARGOTS	111
CHEESE	112
SERVING	113

## BUFFET 123

URBAN	124
MIX&PLAY	142
SQUARE	156
JAMBEE	170
IMPERIAL	174

## TAVOLA / HOLLOWWARE 199

ART&TABLE	200
MENAGE	220
RICAMBI	227
LOUNGE&SERVICE	228
CELSIUS	234

## WINE&BAR 239

## KITCHEN 251

GASTRONORM	252
MANAGE & SERVING	264

## PROMAB 271

KITCHEN	272
HOLLOWWARE	280
PACKAGING	288

Superior	12	Style	25	Bella	38	Splendido	50	Reveil	62	Murano Inox	72
Amarcord	13	Linea	26	Brigitte	39	Perla	51	Scozia	63	Luisa	73
Dolce vita	14	Step	27	Naif	40	Vintage	52	Boston	64	Oslo	74
Dream	15	Più	28	Rem	41	Condor	53	Firenze	65	Eva	75
Niagara	16	Marea	29	Pop	42	Baguette	54	River	66	Corsaro	76
Milord	17	Gourmet	30	Mare	43	Silvia	55	Malta	67	America	77
Elegant	18	Cosmos	31	Med	44	Victory	56	Rimini	68	Wave/A	78
Relais	19	Mirage	32	Garda Top	45	Enrico VIII	57	Toronto	69	Wave/A Inox	78
Ego	20	Infinito	33	Hermitage	46	Alaska	58	Toronto Inox	69	Blade	79
Slim	21	Flair	34	Rinascimento	47	Alaska Inox	58	Valencia	70	Blade Inox	79
Ergo	22	Baltic	35	Rada	48	England	59	Valencia Inox	70	New Line	82
Dinamica	23	Monaco	36	Rada Top	48	London	60	Corona	71	In & Out	83
Allegra	24	Matisse	37	Imperial	49	Verve	61	Murano	72	Baltic Abi	84



# POSATE • CUTLERY

MODERN (12)

CLASSIC (45)

BASIC (64)

COLOR (82)

FINISHING (86)

### Ciclo di produzione

Il ciclo di produzione di forchette e cucchiai inizia con l'operazione di tranciatura (1). Per diminuire lo spessore della tazza rispetto al manico, si procede poi con la laminazione (2), e si prosegue con la rifilatura (3), per dare la forma della tazza o dei rebbi alla posata laminata. Infine si passa alla coniazione (4), nel corso della quale vengono dati la forma e i decori necessari. Per la lavorazione dei coltelli monoblocco forgiati si parte con la tranciatura del tondino in uno spezzone (1), che viene successivamente coniato a caldo (2), in modo da conferirgli una prima forma. Si prosegue con la tranciatura del manico (3) e con l'allungamento della lama (4); in seguito viene effettuata la tranciatura della lama (5), in modo da darle la forma reale. A questo punto rimane da definire la seghettatura sulla lama (6) e rifinire il coltello con le normali operazioni di pulitura. Le fasi di lavorazione dei coltelli a manico cavo forgiati parte con la tranciatura delle valve (1). Le due valve che costituiranno il manico cavo vengono coniate a freddo (2), per dare loro la convessità e i decori, e poi vengono accoppiate e saldate (3): ecco il manico del coltello. Infine, attraverso un composto autobloccante, viene assemblata e saldata al manico la lama (4), prodotta con le stesse tecniche dei coltelli monoblocco forgiati.

### Cutlery manufacturing process

Shearing (1) is the first step in the process of manufacturing forks and spoons. Rolling (2) is used to reduce the bowl thickness compared to that of the handle, and the next step is trimming (3) to give the shape of a bowl or prongs to the laminated implement. The final step is coining (4) during which the implement is shaped and ornamentation stamped. To make forged solid-handle knives the process begins by shearing a bar into a blan (1) that is then hot coined (2) so as to give it some initial shape. Afterwards the handle is sheared (3) and the blade is stretched (4). Then, the blade is sheared (5) so that it takes its final shape. Now blade serration (6) needs to be defined and the knife has to be polished as usual. The first step to make forged hollow-handle knives is shearing the shells (1). The two half-shells that will form the hollow handle are cold-coined (2) to obtain the convexity and stamp the decoration; afterwards the shells are coupled and welded (3). And that is how the knife handle is ready. Finally and by using a self-locking compound the blade, made applying the same techniques used to make forged solid-handle knives, is coupled and welded to the handle (4).



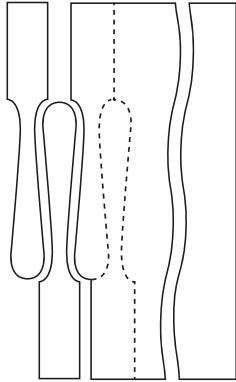

①  
**Tranciatura**  
Blank cutting

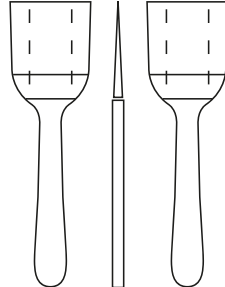

②  
**Laminazione**  
Rolling operation

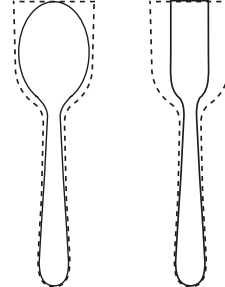

③  
**Rifilatura**  
Overall cutting on outside blank

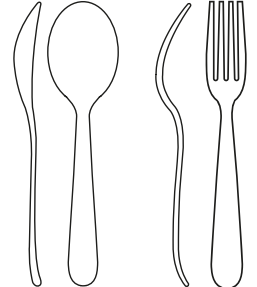

④  
**Coniatura**  
Pressing operation

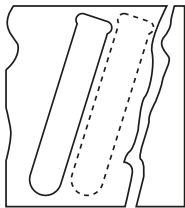

⑤  
**Tranciatura**  
Blank cutting



⑥  
**Coniatura manico**  
Handle pressing



⑦  
**Saldatura gocce**  
Soldering of shells

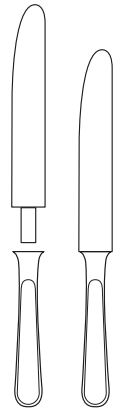

⑧  
**Assemblaggio e saldatura  
lama manico cavo**  
Assembling and soldering  
hollow handle knife



⑨  
**Tranciatura spezzone**  
Rod cutting

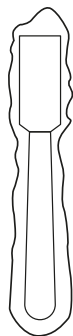

⑩  
**Coniatura a caldo**  
Forging

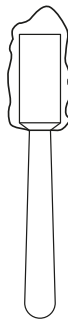

⑪  
**Tranciatura manico**  
Blank cutting of the blade

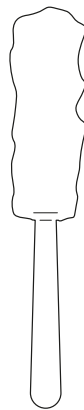

⑫  
**Laminazione**  
Rolling of the blade

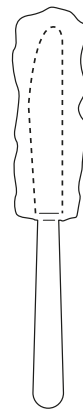



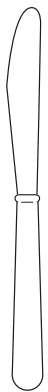







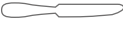
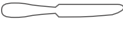













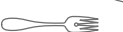
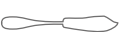





⑬  
**Ritanciatura lama**  
2nd blank cutting  
of the blade



⑭  
**Seghettatura e finitura**  
Blade grinding  
and finishing

# TABELLA POSATE

01		Cucchiaino tavola   Table spoon   Cullière de table   Eßlöffel   Cuchara mesa
02		Forchetta tavola   Table fork   Fourchette de table   Eßgabel   Tenedor mesa
03		Cucchiaino brodo   Bouillon spoon   Cullière à soupe    Suppenlöffel   Cuchara sopa
04		Coltello tavola forgiato pesante   Table knife heavy-forged   Couteau de table forgé lourd   Tafelmesser-schwer   Cuchillo mesa forjado pesado *
05		Coltello tavola forgiato   Table knife-forged   Couteau de table forgé   Tafelmesser   Cuchillo mesa forjado *
05R		Coltello tavola Reverse   Reverse table knife-forged   Couteau de table Reverse   Tafelmesser Reverse   Cuchillo mesa Reverse forjado *
06		Coltello tavola leggero   Table knife-light   Couteau de table léger   Tafelmesser-leicht   Cuchillo mesa ligero *
08		Coltello tavola m/v saldato   Table knife - welded hollow-handle   Couteau de table poignée creuse soudée   Tafelmesser mit Hohlheft   Cuchillo mesa mango hueco soldado *
11		Cucchiaino frutta   Dessert spoon   Cuillère à dessert   Dessertlöffel   Cuchara postre
12		Forchetta frutta   Dessert fork   Fourchette à dessert   Dessertgabel   Tenedor postre
14		Coltello frutta forgiato pesante   Dessert knife-heavy forged   Couteau à dessert forgé lourd   Dessertmesser-schwer   Cuchillo postre forjado pesado *
15		Coltello frutta forgiato   Dessert knife-forged   Couteau à dessert forgé   Dessertmesser   Cuchillo postre forjado *
15R		Coltello frutta Reverse forgiato   Dessert knife forged-Reverse   Couteau à dessert Reverse forgé   Dessertmesser Reverse   Cuchillo postre Reverse forjado *
16		Coltello frutta leggero   Dessert knife-light   Couteau à dessert léger   Dessertmesser-leicht   Cuchillo postre ligero *
18		Coltello frutta m/v saldato   Dessert knife-welded hollow-handle   Couteau à dessert poignée creuse soudée   Dessertmesser mit Hohlheft   Cuchillo postre mango hueco soldado *
21		Cucchiaino caffè   Tea spoon   Cuillère à café   Kaffeelöffel   Cuchara café
22		Cucchiaino moka   Moka spoon   Cuillère à moka   Mokkalöffel   Cuchara moka
23		Cucchiaino zucchero   Sugar spoon   Cuillère à sucre   Zuckerlöffel   Cuchara azucar
25		Mestolo servire   Soup ladle   Louche   Rührlöffel   Cazo sopa
26		Forchettone servire   Serving fork   Fourchette à servir   Vorlegegabel   Tenedor servir
27		Cucchiaione servire   Serving spoon   Cuillère à servir   Vorlegelöffel   Cucharón servir
28		Cucchiaione insalata   Salad serving spoon   Cuillère à servir salade   Salatlöffel   Cucharón servir ensalada
29		Forchettone insalata   Salad serving fork   Fourchette à servir salade   Salatgabel   Tenedor servir ensalada
30		Cucchiaione riso   Salad serving spoon   Cuillère à servir salade   Salatlöffel   Cucharón servir ensalada
31		Forchetta pesce   Fish fork   Fourchette à poisson   Fischgabel   Tenedor pescado
32		Coltello pesce   Fish knife   Couteau à poisson   Fischmesser   Cuchillo pescado
33		Forchettone servire pesce   Fish serving fork   Fourchette à servir poisson   Servierfischgabel   Tenedor servir pescado
34		Coltello servire pesce   Fish serving knife   Couteau à servir poisson   Servierfischmesser   Cuchillo servir pescado
35		Cucchiaino bibita   Ice tea spoon   Cuillère à cocktail   Cocktaillöffel   Cuchara refresco
36		Cucchiaino fragola confetto   Sweets spoon   Cuillère à bonbons   Bonbonlöffel   Cuchara caramelos
37		Paletta gelato   Ice cream spoon   Cuillère à glace   Speiseeislöffel   Cuchara helado
38		Forchettina dolce   Cake fork   Fourchette à tarte   Kuchengabel   Tenedor lunch
39		Pala dolce   Cake server   Pelle à tarte   Tortenschaufel   Pala pastel
40		Coltellone dolce   Cake knife   Gros couteau à tarte   Tortenmesser   Cuchillo pastel
41		Coltellone torta seghettato   Cake knife with serrated blade   Couteau à tarte lame denteleé   Kuchenmesser   Cuchillo pastel dentado
42		Mestolino salsa   Sauce ladle   Louche à sauce   Soßeschöpflöffel   Cacillo salsa
43		Spalmaburro   Butter spreader   Couteau à beurre   Buttermesser   Pala mantequilla
45		Spalmaburro   Butter spreader   Couteau à beurre   Buttermesser   Pala mantequilla
53		Spalmaburro forgiato   Butter spreader - forged   Couteau à beurre forgé   Buttermesser   Pala mantequilla forjado *
55		Coltello bistecca   Steak knife   Couteau à bifteck   Filetmesser   Cuchillo carne *
63		Forchetta lumache 2 punte   2 prongs snail fork   Forchette à escargots à deux dents   Zweizinkengabel fur Schnecke   Tenedor caracoles dos puntas
64		Forchettina ostriche   Oyster fork   Forchette à crustacés   Auster Krustazeengabel   Tenero mariscos
67		Cucchiaino salsa   Sauce spoon   Cuillère à sauce   Soßelöffel   Cuchara salsa
68		Cucchiaino bimbo   Baby spoon   Cuillère enfant   Kinderlöffel   Cuchara niño
69		Forchetta bimbo   Baby fork   Fourchette enfant   Kindergabel   Tenedor niño
70		Coltello bimbo   Baby knife   Couteau enfant   Kindermesser   Cuchillo niño *
80		Cucchiaino lunch   Lunch spoon   Cuillère à lunch   Lunchlöffel   Cuchara lunch

\* materiale: acciaio inossidabile | material: stainless steel |  
matériel: acier inoxydable | Material: aus Edelstahl | material: acero inoxidable

## Istruzioni d'uso e di manutenzione per la posateria e il vasellame in acciaio inox

Lavare accuratamente i prodotti nuovi prima di utilizzarli. Utilizzare per il lavaggio acqua calda ed un buon sapone neutro, risciacquare in seguito con abbondante acqua tiepida ed asciugare scrupolosamente tutti gli articoli.

Non utilizzare per il lavaggio detersivi sintetici a base di cloro o prodotti comunque candeggianti.

Pomice, paglietta d'acciaio, spugnette o panni impregnati di polveri abrasive devono essere altresì rigorosamente esclusi. Possono invece essere utilizzati detersivi non clorurati contenente farina fossile.

E' consigliato il lavaggio degli articoli in acciaio inox subito dopo il loro utilizzo. Qualora questo non fosse possibile è comunque importante non lasciare per più di 12 ore gli articoli sporchi a contatto con i residui alimentari (es: in caso di utilizzo degli articoli a pranzo, andrebbero lavati entro la sera del giorno stesso; in caso di utilizzo degli articoli a cena, andrebbero lavati entro la mattina del giorno seguente).

Nel caso fosse necessario un prelavaggio, questo deve essere fatto appena prima del lavaggio e per un tempo relativamente breve. Gli articoli non vanno infatti lasciati in ammollo nella soluzione lavante per troppo tempo in quanto alcune sostanze contenute negli alimenti sono dannose per l'acciaio inox e ne alterano l'aspetto.

I coltelli e le lame dei coltelli (in caso di articolo a manico cavo) prodotte con un pregiato acciaio inossidabile, sono sensibili agli attacchi corrosivi sviluppati dall'acido acetico, citrico, lattico ed in particolare da cloruro di sodio, presenti negli alimenti.

E' importante, sia in fase di prelavaggio che durante il lavaggio, tenere separate le normali posate (cucchiai, forchette, cucchiaini) dai coltelli e da altri oggetti metallici presenti in cucina.

Nel caso di lavaggio in lavastoviglie le posate devono essere inserite in cestelli verticali di plastica e tenute separate dai coltelli.

Asciugare accuratamente gli articoli con un panno morbido subito dopo il lavaggio, anche se il lavaggio è eseguito in lavastoviglie che prevede un ciclo di asciugatura automatica. Questo è necessario per evitare l'eventuale formazione di macchie dovute a depositi calcarei contenuti nell'acqua.

Non lasciare le posate nell'ambiente umido della lavastoviglie una volta terminato il ciclo di lavaggio, ma asciugarle e riporle in un ambiente asciutto.

Si consiglia di conservare gli articoli perfettamente asciutti, in un ambiente privo di umidità.

Per evitare rigature si consiglia di non conservare alla rinfusa gli articoli ma di riporli ordinatamente e proteggerli con un panno morbido.

## Instructions for use and maintenance of stainless steel cutlery and hollowware

Wash the new products carefully before use.

Use hot water to wash them and a good neutral detergent; then, rinse out with lukewarm water and dry all the items thoroughly.

When washing, do not use chlorinated detergents nor products containing bleach.

Pumice, steel wool, sponges or cloths saturated with abrasive powders must be strictly avoided. However, detergents without chloride containing fossil flour can be used.

The washing of stainless steel items after use is recommended. In case that would not be possible, it is however important not to leave for more than 12 hours the dirty items in contact with food leftovers (e.g.: if the items are used at lunch, they should be washed within the evening; if the items are used at dinner, they should be washed within the following morning).

In case a prewash was needed, it must be carried out just before the washing and for a relatively short time. In fact, the items must not be soaked in the washing solution for too long, since some substances contained in food are damaging for the stainless steel and change its appearance. Knives and knife blades (for hollow

handle items) are manufactured with a valuable stainless steel and are sensitive to the corrosion attacks developed by acetic, citric and lactic acid and in particular to sodium chloride present in food.

It is important, both when pre-washing and washing, to keep cutlery like spoons, forks and tea spoons, separated from knives and other metal kitchenware.

In case of washing in dishwasher, spoons and forks must be placed into plastic vertical baskets and kept separated from knives.

Dry the items thoroughly immediately after the washing with a soft cloth, even if your dishwasher has a dry cycle.

That is necessary in order to avoid the possible formation of stains caused by calcareous deposits contained in the water.

Do not leave the cutlery in the humid environment of the dishwasher once the washing finishes; dry them and store them in a dry place.

It is recommended to storage the items perfectly dried and in a location without humidity.

In order to avoid scratches, it is recommended not to keep the items randomly, but if it is possible, to protect them by soft cloth.













# Superior

Inox 18/10 - St. Steel - 4 mm  
Cod. CZ4..



## COD. CZ4..

## L. Mm

01	
02	
03	
05	
11	
12	
15	
21	
22	
31	
32	
38	

205
206
175
235
185
186
210
137
107
180
200
143



# Amarcord

Inox 18/10 - St. Steel - Forg.  
Cod. CC2..

COD. CC2..		L. Mm
01		214
02		214
03		193
05		235
11		193
12		193
15		212
21		150
22		113
25		305
26		247
27		247
31		185
32		206
38		148
39		251
53		176
55		230

## Dolce vita

Inox 18/10 - St. Steel - Forg.  
Cod. CB8..



**COD. CB8..**

**L. Mm**



214



214



214



235



193



193

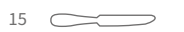

212



150



113



305



247



247



186



203



148

















251



# Dream

Inox 18/10 - St. Steel - Forg.  
Cod. CF9..

COD. CF9..		L. Mm
01		208
02		208
05		235
11		187
12		187
15		210
21		145
22		115
26		239
27		239
30		254
32		198
38		145
39		248













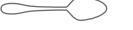

# Niagara

Inox 18/10 - St. Steel - Forg.  
Cod. CZ3..



## COD. CZ3..

## L. Mm

01		210
02		203
05		231
11		181
12		183
15		210
21		142
22		113
25		306
26		237
27		234
38		160
39		250
53		175
55		228





# Milord

Inox 18/10 - St. Steel - 4 mm  
Cod. C14..

COD. C14..		L. Mm
01		197
02		198
03		172
05		233
08		225
11		177
12		178
15		195
18		200
21		133
22		104
25		310
26		228
27		227
31		198
32		212
35		195
36		172
37		129
38		143
39		240
42		175
53		168
55		230
67		184

# Elegant

Inox 18/10 - St. Steel - 4 mm  
Cod. CV6..



## COD. CV6..



L. Mm  
210



210



185



235



236



185



185



210



204

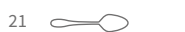

142



114



314



231



229



182



197



145



240



175



# Relais

Inox 18/10 - St. Steel - 4 mm  
Cod. CU3..

COD. CU3..		L. Mm
01		210
02		212
03		185
05		235
11		187
12		192
15		212
21		135
22		112
25		305
26		240
27		240
31		185
32		197
38		143
39		247
53		176
55		230













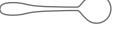



# Ego

Inox 18/10 - St. Steel - 4 mm  
Cod. CD3..



## COD. CD3..













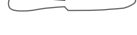



## L. Mm

01		207
02		207
03		182
05		231
11		186
12		186
15		209
21		145
22		114
25		306
26		237
27		234
30		278
32		215
38		150
39		250



# Slim

Inox 18/10 - St. Steel - 4 mm  
Cod. CU7..

COD. CU7..	L. Mm
01 	214
02 	214
03 	193
05 	235
11 	193
12 	193
15 	212
21 	150
22 	113
25 	305
26 	247
27 	247
31 	200
32 	214
38 	148
39 	251
53 	176
55 	230

# Ergo

Inox 18/10 - St. Steel - 4 mm  
Cod. CE5..



## COD. CE5..

## L. Mm

01  207

02  207

03  182

05  231

11  186

12  186

15  209

21  145

22  114

25  306

26  237

27  234

32  215

38  150

39  250















53  175

55  228



# Dinamica

Inox 18/10 - St. Steel - 3 mm  
Cod. CM7..

COD. Cm7..		L. Mm
01		206
02		206
05		235
11		190
12		180
15		210
21		133
22		110
25		290
26		241
27		241
31		206
32		213
38		160
39		241

# Allegra

Inox 18/10 - St. Steel- 3 mm  
Cod. CM6..



## COD. CM6..



203



201



229



180



180



203



140

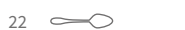

106



155



176



230















## L. Mm

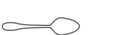



# Style

Inox 18/10 - St. Steel - 3 mm  
Cod. CD6..

COD. CD6..		L. Mm
01		202
02		202
05		230
11		182
12		182
15		208
21		140
22		108
25		310
26		232
27		233
32		201
38		146
39		246















# Linea

Inox 18/10 - St. Steel - 3 mm  
Cod. CF7..



## COD. CF7..















## L. Mm

01		215
02		217
05		231
11		194
12		195,5
15		210
21		155
22		116
25		305
26		255
27		258
32		212
38		155
39		239

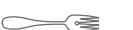

# Step

Inox 18/10 - St. Steel - 3 mm  
Cod. CF8..

COD. CF8..		L. Mm
01		200
02		200
03		178
05		230
11		179
12		181
15		207
21		140
22		109,7
26		231
27		234
30		260
31		180
32		193
38		146
39		255













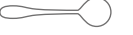
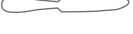

# Più

Inox 18/10 - St. Steel - 3 mm  
Cod. CD7..



## COD. CD7..













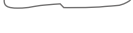



## L. Mm

01		210
02		210
03		180
05		230
11		190
12		190
15		207
21		148
22		114
25		305
26		239
27		239
32		218
38		147
39		251
53		175



# Marea

Inox 18/10 - St. Steel - 3 mm  
Cod. CE4..

COD. CE4..		L. Mm
01		202
02		202
03		169
05		235
11		173
12		175
15		210
21		134
22		117
25		285
26		232
27		230
32		202
35		210
38		155
39		249
53		175









# Gourmet

Inox 18/10 - St. Steel - 3 mm  
Cod. CF5..

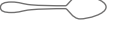

## COD. CF5..















## L. Mm

01		195
02		198
05		227
11		195
12		177
15		202
21		131
22		103
38		153
55		219



# Cosmos

Inox 18/10 - St. Steel - 2,5 mm  
Cod. C06..



















COD. C06..		L. Mm
01		197
02		199
05		213
11		177
12		179
15		200
21		130
22		108
25		305
26		230
27		225
35		197
38		150
39		242
42		178

# Mirage

Inox 18/10 - St. Steel - 2,5 mm  
Cod. C17..



## COD. C17..

		L. Mm
01		197
02		200
05		213
06		223
11		178
12		179
15		199
21		135
22		110
25		314
26		230
27		229
31		203
32		222
35		210
38		159
39		247
55		210













# Infinito

Inox 18/10 - St. Steel- 2,5 mm  
Cod. CV7..

**COD. CV7..**

**L. Mm**

01		207
02		207
05		231
11		186
12		186
15		209
21		145
22		114
38		150

















# Flair

Inox 18/10 - St. Steel - 2,5 mm  
Cod. C02..



## COD. C02..

## L. Mm

01		197
02		200
05		213
11		178
12		179
15		199
21		135
22		110
25		314
26		230
27		229
31		203
32		222
38		159
39		247
53		175
55		220



# Baltic

Inox 18/10 - St. Steel - 2,5 mm  
Cod. CB6..

COD. CB6..		L. Mm
01		195
02		195
05		216
06		215
11		181
12		176
15		192
21		134
22		105
25		307
26		233
27		232
28		223
29		221
32		208
35		209
38		140
39		244
63		158
COD. CB6KO..		L. Mm
68		151
69		151
70		166











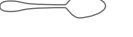

# Monaco

Inox 18/10 - St. Steel - 2,5 mm  
Cod. C34..



## COD. C34..

## L. Mm

01		196
02		195
05		211
11		170
12		173
15		190
21		131
22		110
27		223
31		195
32		205
38		155
39		238
42		???



# Matisse

Inox 18/10 - St. Steel - 2,5 mm  
Cod. CF1..

COD. CF1..		L. Mm
01		204
02		205
03		168
05		230
11		178
12		178
15		208
21		137
22		110
25		295
26		240
27		237
31		203
32		210
35		207
37		133
38		153
39		238
42		170
53		178
55		230
63		156
64		156
80		158

# Bella

Inox 18/10 - St. Steel - 2,2 mm  
Cod. CE3..



## COD. CE3..



L. Mm

204



204



175



230



183



183



207

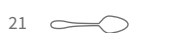

143

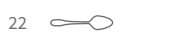

112



270



236



236













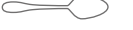



143



# Brigitte

Inox 18/10 - St. Steel - 2 mm  
Cod. C68..

COD. C68..		L. Mm
01		195
02		197
06		213
11		178
12		177
16		190
21		131
22		103
25		315
26		230
27		226
31		190
32		210
38		153
39		240

# Naif

Inox 18/10 - St. Steel - 1,8 mm  
Cod. CE8..

**COD. CE8..**

200



202



220



136















155





# Rem

Inox 18/10 - St. Steel - 1,8 mm  
Cod. C89..

COD. C89..		L. Mm
01		201
02		200
05		223
15		197
21		141
22		111
25		285
26		234
27		235
35		208
38		141
39		226
80		161







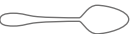

# Pop

Inox 18/10 - St. Steel - 1,8 mm  
Cod. CD4..



## COD. CD4..

## L. Mm











01	
02	
05	
06	
21	
22	
35	
38	

201
200
212
210
141
111
208
141



# Mare

Acciaio inossidabile - St. Steel - 3 mm  
Cod. CN8..

COD. CN8..		L. Mm
01		202
02		202
05		222
11		173
12		175
15		191
21		134
22		117
38		155
53		175
80		144

## Med

Acciaio inossidabile - St. Steel - 2,2 mm  
Cod. CT1..



**COD. CT1..**



204



205



230



137



110













# Garda Top

Inox 18/10 - St. Steel - 4 mm  
Cod. C82T..



**COD. C82T..**

**L. Mm**

01		210
02		210
05		235
11		184
12		184
15		212
21		140
22		110
32		220
38		150

# Hermitage

Inox 18/10 - St. Steel - 5 mm  
Cod. C09..



## COD. C09..

## L. Mm

01  202

02  201

03  178

05  228

11  182

12  181

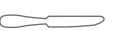
15  205

21  142

22  107

25  312

26  262

27  258

31  200

32  215

38  146

39  252











42  180

53  175



## Rinascimento

Inox 18/10 - St. Steel - 3 mm  
Cod. CHA..





















COD. CHA..		L. Mm
01		198
02		200
03		170
05		235
11		176
12		179
15		210
21		133
22		107
38		154

## Rada

Inox 18/10 - St. Steel - 3 mm  
Cod. C29..

### COD. C29..

### L. Mm









01		208
02		206
03		175
04		236
05		230
11		187
12		187
14		216
15		210
21		142
22		141
25		300
26		227
27		225
31		182
32		201
35		139
37		152
38		142
39		240
55		220

## Rada Top

Inox 18/10 - St. Steel - 4 mm  
Cod. C29T..

### COD. C29T..

### L. Mm

01		206
02		207
04		236
11		187
12		188
14		216
21		140
22		110
38		150





# Imperial

Inox 18/10 - St. Steel - 3 mm  
Cod. C04..



COD. C04..		L. Mm
01		207
02		208
03		174
05		239
08		247
11		187
12		188
15		216
18		214
21		141
22		111
23		116
25		315
26		239
27		239
28		206
29		205
31		186
32		210
33		242
34		260
35		192
36		174
37		133
38		145
39		240
40		255
42		164
53		170
55		220
67		188



















# Splendido

Inox 18/10 - St. Steel - 3,5 mm  
Cod. C19..



## COD. C19..

## L. Mm

01		201
02		200
03		178
05		218
11		180
12		180
15		201
21		140
22		106
25		303
26		230
27		229
31		200
32		214
38		148
39		242
42		179
43		170



# Perla

Inox 18/10 - St. Steel - 3 mm  
Cod. CZ1..

COD. CZ1..		L. Mm
01		200
02		201
03		176
05		235
11		180
12		180
15		204
21		140
22		104
31		197
32		208
38		152

# Vintage

Inox 18/10 - St. Steel - 3 mm  
Cod. CB5..



## COD. CB5..

01 

208

02 

206

05 

229

11 

187

12 

187

15 

206

21 

142

22 

117

25 

300

26 

227

27 

225

31 

181

32 

202

38 

152

39 

242

40 

237











55 

203



# Condor

Inox 18/10 - St. Steel - 2,5 mm  
Cod. C18..













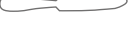
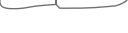







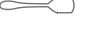

COD. C18..	L. Mm
01 	196
02 	194
05 	212
11 	170
12 	173
15 	197
21 	130
22 	110
26 	227
27 	223
38 	155

# Baguette

Inox 18/10 - St. Steel - 2,5 mm  
Cod. CP1..

COD. CP1..

L. Mm



















01		205
02		205
03		169
05		246
08		225
11		179
12		179
15		195
18		200
21		143
22		110
25		295
26		239
27		236
31		205
32		211
35		207
37		133
38		154
39		238
42		172
45		178
53		175
55		212
67		179

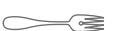



# Silvia

Inox 18/10 - St. Steel - 2,5 mm  
Cod. CP7..

COD. CP7..		L. Mm
01		207
02		206
05		226
11		179
12		179
15		212
21		139
22		112
25		292
26		227
27		227
31		181
32		205
33		221
34		241
38		150
39		268
42		183

# Victory

Inox 18/10 - St. Steel - 2,5 mm  
Cod. CP2..

## COD. CP2..



203



204



167



221



214



247



178



179



208



191



214



137

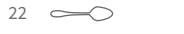

110



299



239



236



203



210



206



132



153



235



170



177



170



227



160







































# Enrico VIII

Inox 18/10 - St. Steel - 2,5 mm  
Cod. CUB..

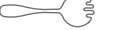
COD. CUB..		L. Mm
01		205
02		204
03		168
05		220
11		186
12		184
15		200
21		137
22		121
31		182
32		193
38		142









# Alaska

Inox 18/10 - St. Steel - 2,2 mm  
Cod. C24..

COD. C24..	L. Mm
01 	195
02 	195
05 	209
06 	212
11 	175
12 	176
15 	190
16 	190
21 	137
22 	103
25 	314
26 	223
27 	223
28 	207
29 	206
35 	208
37 	134
38 	152
39 	224
40 	223
42 	175

# Alaska Inox

Inox 18/CR - St. Steel - 1,8 mm  
Cod. CG3..

COD. CG3..	L. Mm
01 	195
02 	195
*06 	212
21 	128
22 	117
35 	208
37 	134
38 	175

\*C2406L













# England

Inox 18/10 - St. Steel - 2,2 mm  
Cod. C97RO..



**COD. C97RO..**

**L. Mm**

01		203
02		201
05		229
11		180
12		180
15		203
21		140
22		106
38		144
39		245

# London

Inox 18/10 - St. Steel - 2,2 mm  
Cod. CP3..



## COD. CP3..



L. Mm  
203



204



220



177



177



209



137



110



304



237



237



152



234



237









177

## Verve

Inox 18/10 - St. Steel - 1,8 mm  
Cod. C37..

**COD. C37..****L. Mm**

01		199
02		200
03		166
06		212
21		140
22		105
38		145

# Reveil

Inox 18/10 - St. Steel - 1,8 mm  
Cod. C30..



## COD. C30..

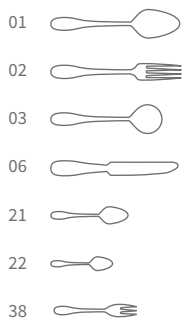

## L. Mm

200  
200  
170  
212  
140  
105  
145









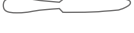

# Scozia

Inox 18/CR - St. Steel - 3,0 mm  
Cod. CN6..

COD. CN6..

L. Mm

01		200
02		200
05		218
11		180
12		180
15		203
21		138
22		105
38		143













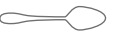





## Boston

Inox 18/10 - St. Steel - 2,5 mm  
 Manico satinato - Mat finishing handle  
 Cod. C39..

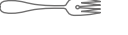

### COD. C39..

### L. Mm

01		195
02		196
05		213
11		173
12		177
15		192
21		132
22		116
25		308
26		225
27		222
28		203
29		205
31		190
32		204
35		206
37		131
38		153
39		240
40		259
42		185













## Firenze

Inox 18/10 - St. Steel - 2,5 mm  
Cod. C84..

**COD. C84..**

**L. Mm**

01		195
02		196
05		208
11		173
12		175
15		194
21		132
22		116
38		152

# River

Inox 18/10 - St. Steel - 2,2 mm  
Cod. CV9..



## COD. CV9..



195



194



229



172



174



191



129

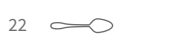

111

















153



# Malta

Inox 18/10 - St. Steel - 1,8 mm  
Cod. C60..

COD. C60..		L. Mm
01		194
02		193
05		215
11		174
12		175
15		194
21		122
22		102
25		298
26		224
27		222
38		141
39		244
42		167

## Rimini

Inox 18/10 - St. Steel - 2 mm  
 Manico satinato - Mat finishing handle  
 Cod. C45..



### COD. C45..



195



194



229



172



174



191



129



111











153

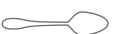









## Toronto

Inox 18/10 -- St. Steel - 2,0 mm  
Cod. CH8..

COD. CH8..		L. Mm
01		195
02		196
05		213
11		173
12		177
15		192
21		132
22		116
38		153

## Toronto Inox

Inox 18/CR - St. Steel - 1,8 mm  
Cod. CG8..

COD. CG8..		L. Mm
01		195
02		196
* 05		213
21		132
22		116
35		206
37		131
38		153



















\*CH805

# Valencia

Inox 18/10 - St. Steel - 1,8 mm  
Cod. CR9..

## COD. CR9..

## L. Mm

01		195
02		198
03		169
05		224
06		215
11		177
12		179
15		209
16		192
21		138
22		110
25		298
26		240
27		236
31		198
32		201
35		207
37		135
38		154











# Valencia Inox

Inox 18/CR - St. Steel - 1,8 mm  
Cod. CG2..

## COD. CG2..

## L. Mm









01		195
02		198
*06		215
21		138
22		110
35		207
37		135
38		154

\*CR906

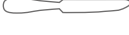
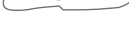
# Corona







Inox 18/10 - St. Steel - 1,8 mm  
Cod. CS0..



COD. CS0..		L. Mm
01		195
02		198
03		169
05		221
06		215
11		177
12		179
15		207
21		138
22		110
38		154







## Murano

Inox 18/10 - St. Steel - 1,8 mm  
Cod. CD5..

COD. CD5..		L. Mm
01		199
02		201
06		211
21		140
22		105
38		145

## Murano Inox

Inox 18/CR - St. Steel- 1,8 mm  
Cod. CG5..

COD. CG5..		L. Mm
01		199
02		201
* 06		211
21		140
22		105
35		187
38		145

\*CD506













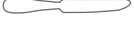



# Luisa

Inox 18/10 - St. Steel - 1,8 mm  
Cod. CS4..

COD. CS4..		L. Mm
01		193
02		196
06		212
11		179
12		180
16		190
21		130
22		124
35		187
37		134
38		145

# Oslo

Inox 18/CR - St. Steel - 2 mm  
 Manico satinato - Mat finishing handle  
 cod. C49..



## COD. C49..

## L. Mm



192



192



210



174



177



190



127



113



283



233



226



151



# Eva

Inox 18/CR - St. Steel - 1,5 mm  
Cod. CT4E..

COD. CT4E..	L. Mm
01	194
02	193
06	209
21	129
22	110
35	207
37	134
38	154

## Corsaro

Inox 18/CR - St. Steel - 1,5 mm  
Cod. CV1..



**COD. CV1..**

**L. Mm**



195



195



212



130



103

















159



# America

Inox 18/CR - St. Steel - 1,5 mm  
Cod. C46..







COD. C46..	L. Mm
01 	193
02 	193
05 	210
06 	212
11 	173
12 	170
15 	190
16 	190
21 	120
22 	102
26 	222
27 	221
38 	141
55 	215

## Wave/A

Inox 18/10 - St. Steel - 1,8 mm  
Cod. CHF..

**COD. CHF..**

**L. Mm**

01		200
02		202
06		220
21		140
22		106
38		142









## Wave/A Inox

Inox 18/CR - St. Steel - 1,8 mm  
Cod. CHD..

**COD. CHD..**







**L. Mm**

01		200
02		202
06		220
21		140
22		106
38		142









## Blade

Inox 18/10 - St. Steel - 1,8 mm  
Cod. CHM..

COD. CHM..		L. Mm
01		200
03		201
06		220
21		141
22		105
38		141

## Blade Inox

Inox 18/CR - St. Steel - 1,8 mm  
Cod. CHL..

COD. CHL..		L. Mm
01		200
03		201
06		220
21		141
22		105
38		141

**Bacchette sushi**

Sushi chopsticks  
 Baguettes à sushi  
 Sushi stäbchen  
 Palillos para sushi

**Inox 18/10 - St. Steel**

	Mm	In
903 05 84 660	226	8,7/8
903 05 84 660 K1	cartella	

**Poggiabastoncini**

Cutlery stand  
 Porte - couverts  
 Posa cubiertos  
 Besteck bänke

**Inox 18/10 - St. Steel**

	Mm	In
118 05 00 081	30x74	1,1/8x3

**Acciaio Argentato - Electro-plated St. Steel (EPSS)**

	Mm	In
118 07 00 081	30x74	1,1/8x3

**Poggiabastoncini**

Cutlery stand  
 Porte - couverts  
 Posa cubiertos  
 Besteck Bänke

**Inox 18/10 - St. Steel**

	Mm	In
903 05 84 662	6x6x56	1/4x1/4x2,1/8





**Bacchette sushi Lapis**

Lapis sushi chopsticks  
 Baguettes à sushi Lapis  
 Lapis Sushi stäbchen  
 Palillos para sushi Lapis

**Inox/Abs - St. Steel/Abs**

	Mm	In
PLA 15 82	230	9

**Poggiabastoncini**

Cutlery stand  
 Porte - couverts  
 Posa cubiertos  
 Besteck Bänke

**Abs**

		Mm	In
1181 20 00 81	Trasp.	50x28x12	2x1,1/8x3/8
1181 20 00 82	Nero	50x28x12	2x1,1/8x3/8

**Legatovaglioli / poggiabastoncini Bamboo**

Bamboo napkin ring / Cutlery stand  
 Rond de serviettes / porte - couverts Bamboo  
 Serviettenhalter / posa cubiertos, Bamboo  
 Servilletero / besteck bänke Bamboo

**Inox 18/10 - St. Steel**

	Cm	H cm
V01 05 81 005	6x3,5 Cm	4







## New Line

Inox 18/10 / ABS - St. Steel / ABS - 2 mm  
Cod. PV9..

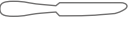

COD. PV9..

L. Mm

01		200
02		205
05		215
21		142
55		216



07



13



14



19



24



47







## In & Out

Nylon / PP  
Cod. PV8..

**In & Out** è la nuova linea di posate in nylon vetrificato versatile, informale e colorata che Abert propone per essere utilizzata con creatività, in casa come in giardino, al ristorante o a bordo piscina, al bar o in barca. Date sfogo alla fantasia con le posate In & Out e usatele quando e dove volete e con serenità: sono solide e resistenti, interamente prodotte in Italia, riutilizzabili e lavabili in lavastoviglie.

**In & Out** is the new glossy-glazed-nylon cutlery, versatile, informal and lively that Abert offers to be used with creativity at home and in the garden, at the restaurant or at the pool side, at the bar or in the boat. Let your imagination run wild with In & Out cutlery and use it when and where you wish and don't be afraid: it is robust and resistant, entirely made in Italy, reusable and washable in dishwasher.

COD. PV8..		L. Mm
01		203
02		201
05		218
21		132

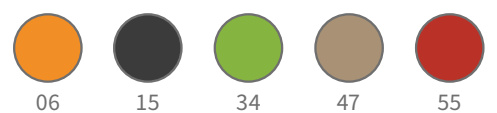

## Baltic Abi

Inox 18/10 - St. Steel - 2,5 mm  
Cod. CB6S..



COD. CB6S..

L. Mm

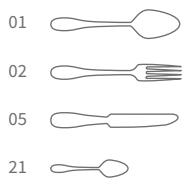

01

195

02

195

05

216

21

134

**Personalizzazioni laser**

Laser customization  
 Personnalisation laser  
 Laserpersonalisierung  
 Personalización láser

**Punzonatura Laser**

Laser punching  
 Poinçonnage laser  
 Laser-Lochen  
 Punzonado laser

**Punzonatura Meccanica**

Mechanical punching  
 Poinçonnage mécanique  
 Mechanish-Lochen  
 Punzonado mecánico

*Ordini minimi 6.000 pezzi per articolo*  
*6.000 pcs/item minimum orders*  
*Commandes minimales de 6.000 pcs par article*  
*Bestellungen von 6.000/Stücke mindestens*  
*Pedidos mínimos de 6.000 pzs por artículo*

**Punzonatura Pantografo**

Pantograph punching  
 Poinçonnage par pantographe  
 Gravierung  
 Punzonado con pantógrafo

**Doratura**

Gold-plating  
 Dorure  
 Vergoldung  
 Dorado





**PVD**

La tecnica PVD (Physical Vapour Deposition) permette di depositare un film metallico di alto spessore con caratteristiche sorprendenti dal punto di vista decorativo e tecnico. Questo procedimento rende il prodotto trattato durevole nel tempo e conferisce elevata durezza superficiale. L'articolo diventa resistente ai solventi, agli acidi e a vari prodotti usati in cucina, mantenendo intatte le proprie caratteristiche chimico/fisiche. E' un trattamento assolutamente biocompatibile, anallergico ed idoneo al contatto con il cibo.

**Polvere di Luna**

La finitura Polvere di Luna rende l'aspetto delle posate satinato e delicatamente brillante: una superficie levigata con chiaroscuri. Piacevoli e vellutate al tatto, trasmettono una morbidezza ed un calore inconsueto per oggetti di acciaio. Un rivestimento sobrio ed inusuale per posate contemporanee.

**Vintage**

L'opacità, i graffi ed i segni volutamente prodotti sulla superficie delle posate con finitura Vintage danno la sensazione di oggetti vissuti ed utilizzati a lungo, di grandi cucine profumate, calde e piene di vapore, di convivialità di altri tempi, di sapori antichi. Evocano immagini di ambienti tradizionali, rustici e senza pretese di modernità.

## FINITURE SPECIALI • SPECIAL FINISH

**PVD**

The PVD (Physical Vapour Deposition) technique allows to deposit a high-thickness metal film with remarkable characteristics from the decorative and technical point of view. Such process makes the product treated durable in time and gives high surface hardness. The item turns resistant to solvents, acids and to various products used in the kitchen, keeping its chemical/physical characteristics unchanged. It is a thoroughly biocompatible, anallergic treatment and suitable for food contact.

**Polvere di Luna**

The Polvere di Luna finish makes cutlery surface look satin-like and delicately brilliant: a smooth surface with contrasting shades. Pleasant and velvety to the touch, the cutlery so treated convey a softness and warmth unusual for steel objects. A sober and unusual coating for contemporary cutlery.

**Vintage**

Opacity, scratches and marks intentionally made on the surface of the cutlery with a finish give the effect of objects that have been used for a long time, of a large, warm and steamy kitchen filled with aromas, of the friendly gatherings of old good times and ancient flavours. They evoke images of traditional, simple environments with no intention to be modern.

## PVD

PVD

Cod. ...41 Oro - Gold

Cod. ...40 Rame - Copper

Cod. ...74 Total Black - Total Black

Cod. ...42 Gun Metal - Gun Metal



**Finitura disponibile per tutti i modelli**

Finish available for all models

**Non disponibile per posate a manico cavo**

Not available for hollow-handle cutlery

**Minimo di ordine 500 pz assortiti**

500 assorted pcs minimum order



**PVD oro**  
PVD Gold

Cod. ...41



**PVD rame**  
PVD Copper

Cod. ...40

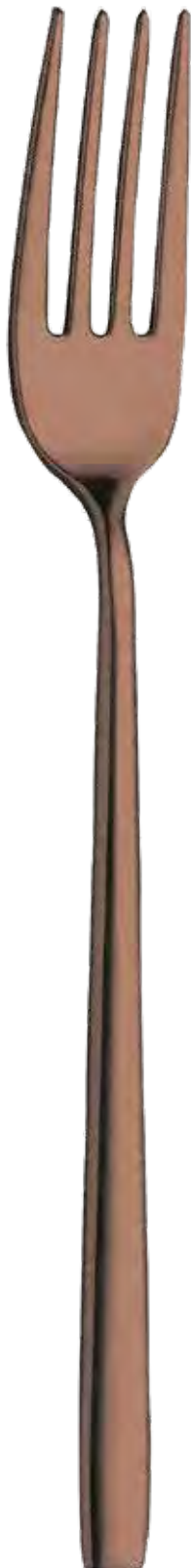

**PVD Total Black**  
PVD Total Black

Cod. ...74



**PVD Gun Metal**  
PVD Gun Metal

Cod. ...42



## Polvere di Luna

Moon Dust  
Cod. ...32



**Finitura disponibile per tutti i modelli**

Finish available for all models

**Non disponibile per posate a manico cavo**

Not available for hollow-handle cutlery

**Minimo di ordine 500 pz assortiti**

500 assorted pcs minimum order

**Polvere di Luna PVD oro**  
Moon Dust PVD Gold

Cod. ...35



**Polvere di Luna PVD rame**  
Moon Dust PVD Copper

Cod. ...53



**Polvere di Luna PVD total black** **Polvere di Luna PVD Gun Metal**  
Moon Dust PVD Total Black      Moon Dust PVD Gun Metal

Cod. ...75



Cod. ...39



## Vintage

Vintage  
Cod. ...51



**Finitura disponibile per tutti i modelli**

Finish available for all models

**Non disponibile per posate a manico cavo**

Not available for hollow-handle cutlery

**Minimo di ordine 500 pz assortiti**

500 assorted pcs minimum order

**Vintage PVD oro**  
Vintage PVD Gold

Cod. ...57



**Vintage PVD rame**  
Vintage PVD Copper

Cod. ...56



**Vintage PVD Total Black**  
Vintage PVD Total Black

Cod. ...76



**Vintage PVD Gun Metal**  
Vintage PVD Gun Metal

Cod. ...58



## Scotch-Brite

Inox Scotch Brite  
Cod. ...73



**Finitura disponibile per tutti i modelli**

Finish available for all models

**Non disponibile per posate in PVD**

Not available in PVD cutlery

**Minimo di ordine 500 pz assortiti**

500 assorted pcs minimum order









ACCESSORI • ACCESSORIES



**Cucchiaino cereali**

Cereal spoon  
Cuillère à céréales  
Cerealienlöffel  
Cuchara de cereales

**Inox 18/10 - St. Steel**

	Mm	In
908 05 00 006	185	7,1/4

**Cucchiaino tè/moka**

Tea spoon  
Cuillère à moka  
Tee-/Mokalöffel  
Cuchara de moka

**Inox 18/10 - St. Steel**

	Mm	In
908 05 00 003	120	4,3/4

**Paletta miscelatore**

Coffee stirrer  
Agitateur à café  
Kaffee-Rührer  
Paleta café

**Inox 18/10 - St. Steel**

	Mm	In
908 05 00 005	100	4

**Cucchiaino spatolina**

Spatula spoon  
Cuillère spatule  
Spatel - Spatenlöffel  
Cuchinilla spatula

**Inox 18/10 - St. Steel**

	Mm	In
908 05 00 002	149	6

**Cucchiaino yogurt/cioccolato/marmellata**

Yogurt / chocolate / jam spoon  
Cuillère à yaourt / chocolat / confiture  
Joghurt / Schokoladen / Marmeladenlöffel  
Cuchara yogur / chocolate / mermelada

**Inox 18/10 - St. Steel**

	Mm	In
908 05 00 001	121	4,3/4



**Cucchiaio moka appetizer con foro Linea**

Linea moka spoon appetizer with hole  
 Cuillère à moka de mise en bouche avec trou Linea  
 Appetizer Mokalöffel mit Lock Linea  
 Cuchara moka aperitivo con agujero Linea

**Inox 18/10 - St. Steel**

	Mm	In
CF7P 22F	106	4,1/8

**Cucchiaio caffè' appetizer Linea**

Linea tea spoon appetizer  
 Cuillère à thé de mise en bouche Linea  
 Appetizer Kaffee/Teelöffel Linea  
 Cuchara café aperitivo Linea

**Inox 18/10 - St. Steel**

	Mm	In
CF7P 21	122	4,3/4

**Forchetta 2 punte appetizer Linea**

Linea fork appetizer, two-prong  
 Fourchette de mise en bouche à deux dents Linea  
 Appetizer Zweizinkengabel Linea  
 Tenedor aperitivo dos puntas Linea

**Inox 18/10 - St. Steel**

	Mm	In
CF7P 63	105	4,1/8

**Cucchiaio moka appetizer Linea**

Linea moka spoon appetizer  
 Cuillère à moka de mise en bouche Linea  
 Appetizer Mokalöffel Linea  
 Cuchara moka aperitivo Linea

**Inox 18/10 - St. Steel**

	Mm	In
CF7P 22	106	4,1/8

**Cucchiaio bibita appetizer Linea**

Linea cocktail spoon  
 Cuillère à mazagan Linea  
 Cocktailöffel Linea  
 Cuchara refresco Linea

**Inox 18/10 - St. Steel**

	Mm	In
CF7P 35	210	8,1/4

**Cucchiaino moka con decoro fiore**

Moka spoon with flower decoration  
 Cuillère à moka avec decoration fleure  
 Mokkalöffel mit beÜhmendekor  
 Cucharita moka con decoración flor

**Inox 18/10 - St. Steel**

	mm	in
CDE 22F	103	4

**Cucchiaino moka con decoro rombo**

Moka spoon with rhombus decoration  
 Cuillère à moka avec decoration losange  
 Mokkalöffel mit karodekor  
 Cucharita moka con decoración rombo

**Inox 18/10 - St. Steel**

	Mm	In
CDE 22S	103	4

**Cucchiaino moka con decoro stella**

Moka spoon with star decoration  
 Cuillère à moka avec decoration étoile  
 Mokkalöffel mit sterndekor  
 Cucharita moka con decoración estrella

**Inox 18/10 - St. Steel**

	mm	in
CDE 22Q	103	4



**Cucchiaino caffè Svezia**

Svezia coffee spoon  
 Cuillère à café Svezia  
 Kaffee/Teelöffel Svezia  
 Cuchara café Svezia

**Inox 18/10 - St. Steel**

	Mm	In
CSV 21	140	5,1/2

**Cucchiaino moka Svezia**

Svezia moka spoon  
 Cuillère à moka Svezia  
 Mokalöffel Svezia  
 Cuchara moka Svezia

**Inox 18/10 - St. Steel**

	Mm	In
CSV 22	105	4,1/8

**Cucchiaino bibita Svezia**

Svezia cocktail spoon  
 Cuillère à cocktail Svezia  
 Cocktailöffel Svezia  
 Cuchara refresco Svezia

**Acciaio Inox - St. Steel**

	Mm	In
CSV 35	204	8

**Forchetta dolce Svezia**

Svezia cake fork  
 Fourchette à gâteau Svezia  
 Kuchengabel Svezia  
 Tenedor lunch Svezia

**Acciaio Inox - St. Steel**

	Mm	In
CSV 38	145	5,3/4

**Cucchiaino gelato Svezia**

Svezia ice cream spoon  
 Cuillère à glace Svezia  
 Eislöffel Svezia  
 Cuchara helado Svezia

**Acciaio Inox - St. Steel**

	Mm	In
CSV 37	131	5,1/8



**Cucchiaino moka Riflesso**

Riflesso moka spoon  
Cuillère à moka Riflesso  
Mokalöffel Riflesso  
Cuchara moka Riflesso

**Inox 18/10 - St. Steel**

	Mm	In
C33P 22	108	4,3/8

**Cucchiaino caffè Riflesso**

Riflesso coffee spoon  
Cuillère à café Riflesso  
Kaffee/Teelöffel Riflesso  
Cuchara café Riflesso

**Inox 18/10 - St. Steel**

	Mm	In
C33P 21	130	5,7/8

**Paletta gelato Riflesso**

Riflesso ice cream spoon  
Cuillère à glace Riflesso  
Eislöffel Riflesso  
Cuchara helado Riflesso

**Inox 18/10 - St. Steel**

	Mm	In
C33P 37	130	5,1/8

**Cucchiaino bibita Riflesso**

Riflesso cocktail spoon  
Cuillère à cocktail Riflesso  
Cocktailöffel Riflesso  
Cuchara refresco Riflesso

**Inox 18/10 - St. Steel**

	Mm	In
C33P 35	201	7,7/8

**Cucchiaino caffè con piega Riflesso**

Riflesso s-shaped tea spoon  
Cuillère à thé pliée  
Riflesso - Gebogener Teelöffel Riflesso  
Cucharita café plegada Riflesso

**Inox 18/10 - St. Steel**

	Mm	In
C33P 392	115	4,1/2

**Cucchiaino bibita con piega Riflesso**

Riflesso s-shaped cocktail spoon  
Cuillère à mazagran pliée Riflesso  
Gebogener Cocktailöffel Riflesso  
Cuchara refresco plegada Riflesso

**Inox 18/10 - St. Steel**

	Mm	In
C33P 394	185	7,1/4

**Forchettina dolce Riflesso**

Riflesso cake fork  
Fourchette à gâteau Riflesso  
Kuchengabel Riflesso  
Tenedor lunch Riflesso

**Inox 18/10 - St. Steel**

	Mm	In
C33P 38	144	5,3/4

**Forchettina 2 punte Riflesso**

Riflesso two-prong fork  
Fourchette à deux dents Riflesso  
Zweizinkengabel Riflesso  
Tenedor dos puntas Riflesso

**Inox 18/10 - St. Steel**

	Mm	In
C33P 63	144	5,3/4



**Cucchiaino caffè bar**

Bar coffee spoon  
Cuillère à café bar  
Kaffee/Teelöffel Bar  
Cuchara café bar

**Acciaio Inox - St. Steel**

	Mm	In
903 06 81 020	133	5,1/8

**Cucchiaino moka 903**

903 Moka spoon  
Cuillère à moka 903  
Mokalöffel 903  
Cuchara moka 903

**Acciaio Inox - St. Steel**

	Mm	In
903 06 81 024	111	4,3/8

**Cucchiaio fragola e confetti Milord**

Milord sweet spoon  
Cuillère à sucreries Milord  
Erdbeer- und Konfektlöffel Milord  
Cuchara para dulces Milord

**Inox 18/10 - St. Steel**

	Mm	In
C14 36	170	6,5/8

**Cucchiaio fragola e confetti Imperial**

Imperial sweet spoon  
Cuillère à sucreries Imperial  
Erdbeer- und Konfektlöffel Imperial  
Cuchara para dulces Imperial

**Inox 18/10 - St. Steel**

	Mm	In
C04 36	170	6,5/8

**Cucchiaio olive con fori**

Olive slotted spoon  
Cuillère de mise en bouche olives perforée  
Gelochter Oliven Löffel  
Cuchara aceitunas perforada

**Inox 18/10 - St. Steel**

	Mm	In
903 05 81 AOF	225	8,7/8

**Cucchiaio olive**

Olive spoon  
Cuillère de mise en bouche olives  
Oliven Löffel  
Cuchara aceitunas

**Inox 18/10 - St. Steel**

	Mm	In
903 05 81 AOL	225	8,7/8



**Cucchiaio multiuso Matisse grande**

Matisse slotted spoon large  
 Cuillère à servir perforée Matisse grande  
 Großer Universallöffel Matisse  
 Cuchara para servir perforada Matisse grande

**Inox 18/10 - St. Steel**

	Mm	In
CF1 162	205	8,1/8

**Cucchiaio ghiaccio Matisse grande**

Matisse slotted long ice spoon  
 Cuillère à glaçons perforée Matisse grande  
 Großer Eiswürfelloffel Matisse  
 Cucharón hielo perforado Matisse grande

**Inox 18/10 - St. Steel**

	Mm	In
CF1 253	205	8,1/8

**Cucchiaio multiuso Matisse piccolo**

Matisse slotted spoon  
 Cuillère à servir perforée Matisse  
 Kleiner Universallöffel Matisse  
 Cuchara para servir perforada Matisse

**Inox 18/10 - St. Steel**

	Mm	In
CF1 161	170	6,5/8

**Cucchiaio ghiaccio Matisse piccolo**

Matisse slotted ice spoon  
 Cuillère à glaçons perforée Matisse  
 Kleiner Eiswürfelloffel Matisse  
 Cuchara hielo perforada Matisse

**Inox 18/10 - St. Steel**

	Mm	In
CF1 251	170	6,5/8

**Cucchiaio multiuso Pop**

Pop slotted spoon  
 Cuillère à servir perforée Pop  
 Universallöffel Pop  
 Cuchara para servir perforada Pop

**Inox 18/10 - St. Steel**

	Mm	In
CD4 162	202	7,8/8

**Cucchiaio ghiaccio Pop**

Pop slotted ice spoon  
 Cuillère à glaçons perforée Pop  
 Eiswürfelloffel Pop  
 Cucharón hielo perforado Pop

**Inox 18/10 - St. Steel**

	Mm	In
CD4 253	202	7,8/8



**Abert presenta Double, il nuovo utensile per... l'assaggio!**

**Innovativo:** grazie alla sua forma metà cucchiaio e metà forchetta è l'unico strumento in grado di permettere assaggi di cibi liquidi e solidi.

**Irrinunciabile per gli chef,** che possono finalmente sperimentare tutte le loro preparazioni con un solo oggetto nel taschino.

**Ingenoso e pratico** per assaporare i cibi in occasione di degustazioni, aperitivi o buffet.

**Abert presents Double, the new tool for... tasting!**

**Innovative:** thanks to its shape half spoon and half fork, it is an instrument able to allow tastes of liquid and solid foods.

**Essential for chefs,** who can at last experiment all their preparations with just one object in their small pocket.

**Ingenious and practical** in order to savour foods at tastings, happy hours or buffets.

**Double**

Double  
Double  
Doppel  
Double

**Inox 18/10 - St. Steel**

	Mm	In
903 05 81 DFS	165	6,1/2

**Appetizer Matisse con riccio**

Curled appetizer  
Cuillère de mise en bouche en boucle  
Appetizerlöffel  
Aperitivo con nudo - cuchara

**Inox 18/10 - St. Steel**

		Mm	In
CF1 CR	SPOON	141	5,1/2
CF1 FR	FORK	136	5,3/8

**Appetizer Matisse con piega - cucchiaio**

Bended appetizer spoon  
Cuillère de mise en bouche pliée  
Appetizerlöffel  
Aperitivo plegada - cuchara

**Inox 18/10 - St. Steel**

		Mm	In
CF1 CP	SPOON	142	5,1/2
CF1 FP	FORK	138	5,3/8





**Forchettina appetizer segnaposto**

Place-card appetizer fork  
Fourchette de mise en bouche marque-place  
Tischkarte Appetizer Gabel  
Tenedor aperitivo etiqueta

**Inox 18/10 - St. Steel**

	H Mm	H In
903 05 81 APF	97	3,7/8

**Tapas Matisse**

Matisse Tapas  
Cuillère Tapas Matisse  
Tapas Matisse  
Tapas Matisse

**Inox 18/10 - St. Steel**

	Mm	In
CF1 TA	170	6,3/4

**Cucchiaio appetizer tondo**

Appetizer curved spoon  
Cuillère de mise en bouche ronde pliée  
Appetizer - rund gebogener Löffel  
Cuchara aperitivo redonda plegada

**Inox 18/10 - St. Steel**

	Mm	In
903 05 81 APC	140	5,1/2

**Appetizer Brigitte con piega**

Bended appetizer spoon Brigitte  
Mise en bouche pliée Brigitte  
Appetizerlöffel Brigitte  
Aperitivo plegada Brigitte

**Inox 18/10 - St. Steel**

	Mm	In	
C68 CP	142	5,1/2	SPOON
C68 FP	142	5,1/2	FORK

**Mini appetizer Ego**

Ego mini appetizer  
Mini mise en bouche Ego  
Mini Appetizer Ego  
Mini aperitivo Ego

**Inox 18/10 - St. Steel**

	Mm	In	
CD3 38M	115	4,1/2	FORK
CD3 22	115	4,1/2	SPOON



**Coltello carne Modern seghettato**

Modern steak knife  
 Couteau à bifteck Modern  
 Modern Steakmesser  
 Cuchillo carne Modern

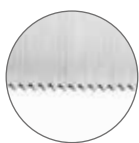
**Acciaio Inox / ABS - St. Steel / ABS**

	Mm	In
903 06 86 A	227	9

**Coltello carne Modern filo rasoio**

Modern steak knife  
 Couteau à bifteck Modern  
 Modern Steakmesser  
 Cuchillo carne Modern

**Acciaio Inox / ABS - St. Steel / ABS**

	Mm	In
903 06 86 B	227	9

**Coltello Angus seghettato**

Angus steak knife  
 Couteau à bifteck Angus  
 Angus Steakmesser  
 Cuchillo carne Angus

**Acciaio Inox / POM - St. Steel / POM**

	Mm	In
CAN 55	229	9

**Coltello Angus filo rasoio**

Angus steak knife  
 Couteau à bifteck Angus  
 Angus Steakmesser  
 Cuchillo carne Angus

**Acciaio Inox / POM - St. Steel / POM**

	Mm	In
CAN 55R	229	9

**Coltello carne lama 12 Cm**

Steak knife, blade 12Cm  
 Couteau à bifteck 12Cm  
 12Cm Steakmesser  
 Cuchillo carne 12Cm

**Acciaio Inox / PP - St. Steel / PP**

	Mm	In
AVARI 180	228	9

**Coltello carne Kansas**

Kansas steak knife  
 Couteau à bifteck Kansas  
 Kansas Steakmesser  
 Cuchillo carne Kansas

**Acciaio Inox / POM - St. Steel / POM**

	Mm	In
CKA 55	218	8,5/8



## Coltello carne Kobe

Kobe steak knife  
 Couteau à bifteck Kobe  
 Kobe Steakmesser  
 Cuchillo carne Kobe

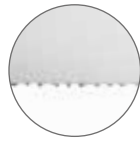

**Acciaio Inox / Legno - St. Steel / Wood**

	Mm	In
CKO 55	244	9,5/8



## Coltello carne Kobe

Kobe steak knife  
 Couteau à bifteck Kobe  
 Kobe Steakmesser  
 Cuchillo carne Kobe



**Acciaio Inox / Legno - St. Steel / Wood**

	Mm	In
CKO 55R	244	9,5/8



## Coltello carne Fuego

Fuego steak knife  
 Couteau à bifteck Fuego  
 Fuego Steakmesser  
 Cuchillo carne Fuego



**Acciaio Inox / ABS - St. Steel / ABS**

	Mm	In
CFU 55	232	9



## Coltello carne Fuego

Fuego steak knife  
 Couteau à bifteck Fuego  
 Fuego Steakmesser  
 Cuchillo carne Fuego



**Acciaio Inox / ABS - St. Steel / ABS**

	Mm	In
CFU 55R	232	9



## Coltello carne Boty

Boty steak knife  
 Couteau à bifteck Boty  
 Boty Fleischmesser  
 Cuchillo carne Boty



**Acciaio Inox - St. Steel**

	Mm	In
CD2 55	235	9,1/4



## Coltello carne Boty

Boty steak knife  
 Couteau à bifteck Boty  
 Boty Fleischmesser  
 Cuchillo carne Boty



**Acciaio Inox - St. Steel**

	Mm	In
CD2 55R	235	9,1/4



**Coltello fiorentina**

Fiorentina steak knife  
 Couteau à bifteck Fiorentina  
 Fiorentina Steakmesser  
 Cuchillo carne Fiorentina

**Acciaio Inox - St. Steel**

	Mm	In
CFI 55	230	9

**Forchetta fiorentina**

Fiorentina steak fork  
 Fourchette à bifteck Fiorentina  
 Fiorentina Steakgabel  
 Tenedor carne Fiorentina

**Inox 18/10 - St. Steel**

	Mm	In
CFI 02	204	8

**Coltello carne Pampero**

Pampero steak knife  
 Couteau à bifteck Pampero  
 Pampero Steakmesser  
 Cuchillo carne Pampero

**Acciaio Inox - St. Steel**

	Mm	In
CPP 55	222	8,5/8

**Forchetta carne Pampa**

Pampa steak fork  
 Fourchette à bifteck Pampa  
 Pampa Steakgabel  
 Tenedor carne Pampa

**Inox 18/10 - St. Steel**

	Mm	In
CPA 52	197	7,5/8

**Coltello carne Malaga**

Malaga steak knife  
 Couteau à bifteck Malaga  
 Malaga Fleischmesser  
 Cuchillo carne Malaga

**Acciaio Inox - St. Steel**

	Mm	In
CMA 55	231	8,5/8

**Forchetta carne Altozano/Malaga**

Altozano steak fork  
 Fourchette à bifteck Altozano  
 Altozano Steakgabel  
 Tenedor carne Altozano

**Acciaio Inox - St. Steel**

	Mm	In
CAL 52	205	8

**Coltello pizza Azzurra**

Azzurra pizza knife  
 Couteau à pizza Azzurra  
 Azzurra Pizzamesser  
 Cuchillo pizza Azzurra

**Acciaio Inox - St. Steel**

	Mm	In
CZ 7134	225	8,7/8

**Forchetta pizza Azzurra**

Azzurra pizza fork  
 Fourchette à pizza Azzurra  
 Azzurra Pizzagabel  
 Tenedor pizza Azzurra

**Acciaio Inox - St. Steel**

	Mm	In
CZ 752	200	7,7/8



## Coltello pizza Modern acciaio

Modern pizza knife  
Couteau à pizza Modern  
Modern Pizzamesser  
Cuchillo pizza Modern

### Acciaio Inox - St. Steel

	Mm	In
CPI 05P	205	8



## Forchetta pizza Modern acciaio

Modern pizza fork  
Fourchette à pizza Modern  
Modern Pizzagabel  
Tenedor pizza Modern

### Acciaio Inox - St. Steel

	Mm	In
CPI 02 CR	203	7,7/8



## Coltello carne America monoblocco

America steak knife, solid handle  
Couteau à bifteck America monobloc  
Steakmesser America, monoblock  
Cuchillo carne America monobloque

### Acciaio Inox - St. Steel

	Mm	In
C46 55	210	9



## Coltello carne Modern acciaio

Modern steak knife  
Couteau à bifteck Modern  
Modern Steakmesser  
Cuchillo carne Modern

### Acciaio Inox - St. Steel

	Mm	In
CPI 05	226	8,7/8



## Coltello pizza Palio

Pizza knife Palio  
Couteau à pizza Palio  
Palio Pizzamesser  
Cuchillo pizza Palio

### Acciaio Inox - St. Steel

	Mm	In
CC3 134	210	8,1/4



## Coltello carne Pampero / C

Pampero steak knife  
Couteau à bifteck Pampero  
Pampero Steakmesser  
Cuchillo carne Pampero

### Acciaio Inox - St. Steel

	Mm	In
CPP 55/C	222	8,5/8



**Coltello carne Rost punta**

Rost steak knife  
 Couteau à viande Rost  
 Fleischmesser Rost  
 Cuchillo carne Rost

**Acciaio Inox manico nero**

AVARI 064B 06 pz.6  
 AVARI 064B 12 pz.12

**Coltello carne Rost punta tonda**

Rost steak knife round point  
 Couteau à viande Rost pointe ronde  
 Fleischmesser Rost  
 Cuchillo carne Rost con punta redonda

**Acciaio Inox manico nero**

AVARI 064T B06 pz.6  
 AVARI 064T B12 pz.12

**Coltello pizza Rost**

Pizza knife Rost  
 Couteau à pizza Rost  
 Rost Pizzamesser  
 Cuchillo pizza Rost

**Acciaio Inox manico nero**

AVARI 064P B06 pz.6  
 AVARI 064P B12 pz.12

**Coltello carne Arlecchino punta**

Arlecchino steak knife  
 Couteau à viande Arlecchino  
 Fleischmesser Arlecchino  
 Cuchillo carne Arlecchino

**Acciaio Inox colori assortiti**

	Mm	In	
● AVARI 047 47	211	8,1/4	pz.6
● AVARI 047 07	211	8,1/4	pz.6
○ AVARI 047 13	211	8,1/4	pz.6
● AVARI 047 34	211	8,1/4	pz.6
● AVARI 047 06	211	8,1/4	pz.6
○ AVARI 047 19	211	8,1/4	pz.6
● AVARI 047 14	211	8,1/4	pz.6

**Coltello carne Arlecchino punta tonda**

Arlecchino steak knife round point  
 Couteau à viande Arlecchino pointe ronde  
 Fleischmesser Arlecchino  
 Cuchillo carne Arlecchino con punta redonda

**Acciaio Inox colori assortiti**

	Mm	In	
● AVARI 047T 47	211	8,1/4	pz.6
● AVARI 047T 07	211	8,1/4	pz.6
○ AVARI 047T 13	211	8,1/4	pz.6
● AVARI 047T 34	211	8,1/4	pz.6
● AVARI 047T 06	211	8,1/4	pz.6
○ AVARI 047T 19	211	8,1/4	pz.6
● AVARI 047T 14	211	8,1/4	pz.6



**Pinza aragosta forgiata**

Lobster cracker, forged  
Pince à homard forgé  
Langustezange - geschmieden  
Pinzas langosta forjadas

**Acciaio Inox - St. Steel**

	Mm	In
305 05 91 658	210	8,1/4

**Stiletto aragosta**

Lobster pick  
Fourchette à homard  
Langustegabel  
Tenedor langosta

**Inox 18/10 - St. Steel**

	Mm	In
903 05 84 659	202	7,7/8

**Forchettina ostriche**

Oyster fork  
Fourchette à crustacés  
Austerngabel  
Tenedor ostras

**Inox 18/10 - St. Steel**

	Mm	In
CF1 64	156	6,1/8

**Stiletto ostriche/crostacei**

Oyster fork  
Fourchette à crustacés  
Krustengabel  
Tenedor mariscos

**Inox 18/10 - St. Steel**

	Mm	In
CPA 64	227	8,7/8

**Forchettina 2 punte Matisse**

Matisse fork, two-prong  
Fourchette à deux dents Matisse  
Zweizinkengabel Matisse  
Tenedor dos puntas Matisse

**Inox 18/10 - St. Steel**

	Mm	In
CF1 63	156	3,1/8

**Molla lumache**

Snail tongs  
Pince à escargots  
Schneckenzange  
Pinzas caracoles

**Acciaio Inox - St. Steel**

	Mm	In
903 05 81 MLU	160	6,1/4



**Coltello formaggi cremosi Regis Spalmy**

Spalmy creamy cheese knife  
 Couteau à fromages crèmeux Spalmy  
 Schmelzkäsemesser Spalmy  
 Cuchillo quesos cremosos Spalmy

**Acciaio Inox - St. Steel**

	Mm	In
903 05 84D	225	8,7/8

**Coltello paste molli Regis Tommy**

Tommy tender cheese knife  
 Couteau à fromages à pâte molle Tommy  
 Weichkäsemesser Tommy  
 Cuchillo quesos pasta blanda Tommy

**Acciaio Inox - St. Steel**

	Mm	In
903 05 84A	218	8,5/8

**Coltello 2 punte Regis Emmy**

Emmy medium-hard cheese knife  
 Couteau à fromages à pâte demi-ferme Emmy  
 Milderkäsemesser Emmy  
 Cuchillo quesos pasta semi-dura Emmy

**Acciaio Inox - St. Steel**

	Mm	In
903 05 84B	221	8,5/8

**Coltello formaggi di paste crude Regis Parmy**

Parmy hard cheese knife  
 Couteau à fromages à pâte ferme Parmy  
 Hartkäsemesser Parmy  
 Cuchillo quesos pasta dura Parmy

**Acciaio Inox - St. Steel**

	Mm	In
903 05 84C	199	7,7/8

**Coltello formaggelle Regis Formy**

Formy formaggelle soft cheese knife  
 Couteau à fromages à pâte molle formaggelle Formy  
 Frischkäsemesser Formy  
 Cuchillo quesos pasta blanda formaggelle Formy

**Acciaio Inox - St. Steel**

	Mm	In
903 05 84E	273	10,5/8

**Coltello agrumi Regis**

Regis citrus fruit knife  
 Couteau à agrumes Regis  
 Orangenmesser Regis  
 Cuchillo cítricos Regis

**Acciaio Inox - St. Steel**

	Mm	In
903 05 84 269	220	8,5/8

**Affettaformaggio Regis 18/10**

Regis cheese slicer  
 Pelle coupe-fromage Regis  
 Käsehobel Regis  
 Pala corta queso Regis

**Acciaio Inox - St. Steel**

	Mm	In
903 05 84 135	190	7,1/2





**Schiaccianoci forgiato**

Nut cracker - forged  
Casse noix forgé  
Nußknacker geschmieden  
Cascanueces forjado

**Inox 18/10 - St. Steel**

	Mm	In
AVARI 117	150	6

**Schiaccianoci**

Nut cracker  
Casse noix  
Nußknacker  
Cascanueces

**Inox 18/10 - St. Steel**

	Mm	In
903 05 84 163	220	8,5/8

**Paletta raccoglibriciole**

Crumb sweeper  
Pelle ramasse-miettes  
Krümelsammler  
Pala recogemigas

**Inox 18/10 - St. Steel**

	Mm	In
903 05 91 939	160	6,1/4

**Easy Spaghetti e pasta 3 in 1****Dosaspaghetti - Assaggiapaghetti - Assaggiapasta**

Spaghetti doser - Spaghetti taster - Pasta taster  
Doseur spaghetti - Goute-spaghetti - Goute-pâtes  
Spaghetti-Maß - Spaghettitester - Nudel-Tester  
Dosificador de espagueti - Prueba espagueti - Prueba pasta

**Inox 18/10 - St. Steel**

	Mm	In
903 05 81 ESP	225	8,7/8



**Forchettone spaghetti**

Spaghetti serving fork  
Fourchette à servir spaghetti  
Spaghettigabel  
Tenedor servir spaghetti

**Inox 18/10 - St. Steel**

	Mm	In
903 05 91 792	278	11

**Mestolo punch**

Punch ladle  
Louche à punch  
Punch Schöpflöffel  
Cazo punch Svezia

**Inox 18/10 - St. Steel**

	Mm	In
CSV 66	280	11

**Cucchiaio insalata con piega Pivot**

Pivot curved salad spoon  
Grosse cuillère à salade pliée Pivot  
Gebogene Salatlöffel Pivot  
Cuchara ensalada plegada Pivot

**Inox 18/10 - St. Steel**

	Mm	In
CD8 28	255	10,1/8

**Forchetta insalata con piega Pivot**

Pivot curved salad fork  
Grosse fourchette à salade pliée Pivot  
Gebogene Salatgabel Pivot  
Tenedor ensalada plegado Pivot

**Inox 18/10 - St. Steel**

	Mm	In
CD8 29	255	10,1/8

**Cucchiaio forato multiuso con piega Pivot**

Pivot curved slotted spoon  
Cuillère perforée à servir pliée Pivot  
Gebogener, gelochter Universallöffel Pivot  
Cuchara perforada para servir plegada Pivot

**Inox 18/10 - St. Steel**

	Mm	In
CD8 162	255	10,1/8

**Cucchiaio ghiaccio multiuso con piega Pivot**

Pivot slotted long ice spoon  
Cuillère à glaçons / salade pliée Pivot  
Gebogener Universaleislöffel Pivot  
Cucharón hielo / ensalada plegado Pivot

**Inox 18/10 - St. Steel**

	Mm	In
CD8 253	255	10,1/8



**Mestolo con piega**

S-shaped soup ladle  
Louche pli e  
Gebogener Sch opfl offel  
Cazo sopa plegado

**Inox 18/10 - St. Steel**

	Mm	In
C00 25CP	275	10,7/8

**Cucchiaio macedonia con piega**

S-shaped fruit salad spoon  
Cuill ere  a salade de fruits pli e  
Gebogener Obstsalatl offel  
Cuchara ensalada de frutas plegada

**Inox 18/10 - St. Steel**

	Mm	In
C00 27CP	215	8,1/2

**Forchetta multiuso con piega**

S-shaped fork  
Fourchette pli e  
Gebogene Universalgabel  
Tenedor plegado

**Inox 18/10 - St. Steel**

	Mm	In
C00 26CP	215	8,1/2

**Cucchiaio servi miele con piega**

S-shaped honey serving spoon  
Cuill ere  a miel pli e  
Gebogener Honigl offel  
Cuchara para miel plegada

**Inox 18/10 - St. Steel**

	Mm	In
C89 390	140	5,1/2



**Cucchiaine riso professionale**

Professional rice-serving spoon  
Cuillère à riz professionnelle  
Reislöffel  
Cucharón arroz profesional

**Inox 18/10 - St. Steel**

	Mm	In
903 05 91 795	256	10

**Pala fritto professionale**

Professional frying palette  
Pelle à friture professionnelle  
Schaufel  
Pala frito profesiona

**Inox 18/10 - St. Steel**

	Mm	In
903 05 91 062	295	11,5/8

**Cucchiaine forato professionale**

Professional slotted serving spoon  
Cuillère perforée professionnelle  
Gelochter Löffel  
Cucharón servir perforado profesional

**Inox 18/10 - St. Steel**

	Mm	In
903 05 91 796	290	11,1/2

**Cucchiaine ghiaccio professionale**

Professional ice-serving spoon  
Cuillère à glaçons professionnelle  
Eislöffel  
Cucharón hielo profesional

**Inox 18/10 - St. Steel**

	Mm	In
903 05 91 063	290	11,1/2

**Cucchiaine insalata professionale**

Professional salad-serving spoon  
Cuillère à salade professionnelle  
Salatlöffel  
Cucharón ensalada profesional

**Inox 18/10 - St. Steel**

	Mm	In
903 05 91 066	285	11,1/4

**Cucchiaine servire professionale**

Professional serving spoon  
Cuillère à servir professionnelle  
Löffel  
Cucharón servir profesional

**Inox 18/10 - St. Steel**

	Mm	In
903 05 91 793	290	11,1/2

**Cucchiaine riso forato professionale**

Professional rice-serving spoon  
Cuillère à riz professionnelle  
Reislöffel  
Cucharón arroz profesional

**Inox 18/10 - St. Steel**

	Mm	In
903 05 91 795 F	256	10

**Mestolo professionale**

Professional ladle  
Louche professionnelle  
Professionelle Schöpfkelle  
Cazo profesional

**Inox 18/10 - St. Steel**

	Mm	In
903 05 91 025	288	11,3/4



**Forchettone servire professionale**

Professional serving fork  
Fourchette à servir professionnelle  
Gabel  
Tenedor servir profesional

**Inox 18/10 - St. Steel**

	Mm	In
903 05 91 794	294	11,5/8

**Forchettone arrosto professionale**

Professional carving fork  
Grande fourchette rôti professionnelle  
Fleischgabel  
Tenedor asado profesional

**Inox 18/10 - St. Steel**

	Mm	In
903 05 91 064	285	11,1/4

**Coltello torta seghettato professionale**

Professional serrated-edge cake knife  
Couteau à gâteau professionnel lame dentelée  
Kuchmesser  
Cuchillo pastel profesional dentado

**Inox 18/10 - St. Steel**

	Mm	In	
903 05 91 788	297	11,3/4	seghettato / serrated

**Coltello torta professionale**

Professional cake knife  
Couteau à gâteau professionnel  
Tortennmesser  
Cuchillo pastel profesional

**Inox 18/10 - St. Steel**

	Mm	In
903 05 91 798	297	11,3/4

**Pala torta seghettata professionale**

Professional serrated-edge cake server  
Pelle à gâteau dentelée professionnelle  
Tortenschaufel  
Pala pastel profesional dentada

**Inox 18/10 - St. Steel**

	Mm	In
903 05 91 786	297	11,3/4

**Pala torta professionale**

Professional cake server  
Pelle à gâteau professionnelle  
Tortenschaufel  
Pala pastel profesional

**Inox 18/10 - St. Steel**

	Mm	In
903 05 91 799	297	11,3/4

**Spatola crepes professionale**

Professional crepes server  
Spatule à crêpes professionnelle  
Crepesschaufel  
Pala crepes profesional

**Inox 18/10 - St. Steel**

	Mm	In
903 05 91 065	292	11,1/2

**Pala gratin professionale**

Professional gratin server  
Pelle à gratin professionnelle  
Backschaufel  
Pala lasaña profesional

**Inox 18/10 - St. Steel**

	Mm	In	
903 05 91 787	268	10,5/8	seghettata / serrated
903 05 91 797	268	10,5/8	



**Molla insalata o vegetali**

Salad-vegetable tongs  
Pince à légumes  
Gemüsezange  
Pinza para ensalada

**Acciaio Inox - St. Steel**

	Mm	In
CI 18601	195	7,5/8

**Molla servire**

Serving tongs  
Pince à servir  
Servierzange  
Pinza de servicio

**Acciaio Inox - St. Steel**

	Mm	In
CI 18602	195	7,5/8

**Molla asparagi**

Asparagus tongs  
Pince à asperges  
Spargelzange  
Pinza para espàrragos

**Acciaio Inox - St. Steel**

	Mm	In
CI 18603	195	7,5/8

**Molla pasta**

Pasta tongs  
Pince pasta  
Pastazange  
Pinza pasta

**Acciaio Inox - St. Steel**

	Mm	In
CI 18604	195	7,5/8

**Molla dolci / toast**

Cake tongs  
Pince à pâtisserie  
Gebäckzange  
Pinza para pasteles

**Acciaio Inox - St. Steel**

	Mm	In
CI 18703	180	7



**Molla per pane Cosmos**

Cosmos bread tongs  
Pince à pain Cosmos  
Brotzange Cosmos  
Pinzas pan Cosmos

**Acciaio inossidabile - St. Steel**

	Mm	In
● V53 05 81 MPA 15	225	8,7/8
● V53 05 81 MPA 34	225	8,7/8
● V53 05 81 MPA 41	225	8,7/8
● V53 05 81 MPA 43	225	8,7/8
● V53 05 81 MPA 47	225	8,7/8

**Molla per spaghetti Cosmos**

Cosmos spaghetti tongs  
Pince à spaghetti Cosmos  
Spghettizange Cosmos  
Pinzas spaghetti Cosmos

**Acciaio inossidabile - St. Steel**

	Mm	In
● V53 05 81 MSP 15	230	9,1/8
● V53 05 81 MSP 34	230	9,1/8
● V53 05 81 MSP 41	230	9,1/8
● V53 05 81 MSP 43	230	9,1/8
● V53 05 81 MSP 47	230	9,1/8

**Molla per arrosto Cosmos**

Cosmos roast tongs  
Pince à rôti Cosmos  
Braten/Fleischzange Cosmos  
Pinzas asado Cosmos

**Acciaio inossidabile - St. Steel**

	Mm	In
● V53 05 81 MAR 15	220	8,5/8
● V53 05 81 MAR 34	220	8,5/8
● V53 05 81 MAR 41	220	8,5/8
● V53 05 81 MAR 43	220	8,5/8
● V53 05 81 MAR 47	220	8,5/8

**Molla per dolce Cosmos**

Cosmos cake tongs  
Pince à gâteau Cosmos  
Gebäckzange Cosmos  
Pinzas postre Cosmos

**Acciaio inossidabile - St. Steel**

	Mm	In
● V53 05 81 MDO 15	220	8,5/8
● V53 05 81 MDO 34	220	8,5/8
● V53 05 81 MDO 41	220	8,5/8
● V53 05 81 MDO 43	220	8,5/8
● V53 05 81 MDO 47	220	8,5/8

**Molla per ghiaccio Cosmos**

Cosmos ice tongs  
Pince à glace Cosmos  
Eiszange Cosmos  
Pinzas hielo Cosmos

**Acciaio inossidabile - St. Steel**

	Mm	In
● V53 05 81 MGH 15	214	8,3/8
● V53 05 81 MGH 34	214	8,3/8
● V53 05 81 MGH 41	214	8,3/8
● V53 05 81 MGH 43	214	8,3/8
● V53 05 81 MGH 47	214	8,3/8



**Molla arrosto Modern**

Roast tongs  
Pince à rôti  
Fleischzange  
Pinzas asado

**Acciaio Inox - St. Steel**

	Mm	In
903 05 81 MAR	250	8,7/8

**Molla dolci Modern**

Cake tongs  
Pince à gâteaux  
Gebäckzange  
Pinzas postre

**Acciaio Inox - St. Steel**

	Mm	In
903 05 81 MDO	250	8,7/8

**Molla ghiaccio Modern**

Ice tongs  
Pince à glaçons  
Eiszange  
Pinzas hielo

**Acciaio Inox - St. Steel**

	Mm	In
903 05 81 MGH	200	7,7/8

**Molla spaghetti Modern**

Spaghetti tongs  
Pince à spaghetti  
Spaghettizange  
Pinzas spaghetti

**Acciaio Inox - St. Steel**

	Mm	In
903 05 81 MSP	250	8,7/8





**Molla insalata Long**

Salad tongs  
Pince à salade  
Salatzange  
Pinzas ensalada

**Acciaio Inox - St. Steel**

	Mm	In
903 05 81 MIN	270	10,5/8

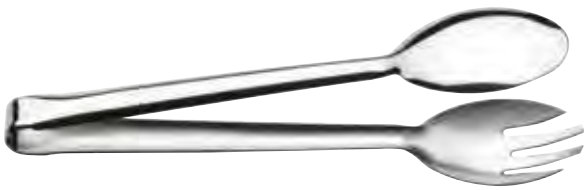
**Molla pasta Long**

Pasta tongs  
Pince à pâtes  
Pastazange  
Pinzas pasta

**Acciaio Inox - St. Steel**

	Mm	In
903 05 81 MPA	270	10,5/8

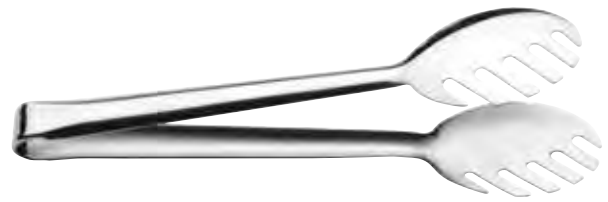
**Molla multiuso Long**

Multipurpose tongs  
Pince à servir  
Multipurposezange  
Pinzas para servir

**Acciaio Inox - St. Steel**

	Mm	In
903 05 81 MMU	295	11,5/8

**Molla Universal Long**

Universal tongs  
Pince Universal  
Universalzange  
Pinzas Universal

**Acciaio Inox - St. Steel**

	Mm	In
903 05 81 MUN	270	10,5/8







- BUFFET



# Urban

**Abert firma Urban**, un supporto creativo per le preparazioni in sala, versatile, fantasioso e bello da vedere.

**Base ideale per un buffet di finger food**, impeccabile supporto da colazione grazie ai numerosi accessori correlati e perfetto allestimento emozionale per aperitivi e brunch.

**Urban è facile da allestire** e consente la veloce creazione di figure geometriche modulari sempre diverse, per posizionare ogni creazione culinaria secondo la propria fantasia.

**Abert has designed Urban**, a creative support for food preparation in the restaurants, versatile, multipurpose and nice to see.

**Ideal base for a finger-food buffet**, perfect lunch podium system thanks to the numerous accessories provided, and impressive set-up for the happy hour and the brunch.

**Urban is easy to assemble** and allows the fast creation of continuously different modular shapes, in order to place every food preparation according to everyone's imagination.

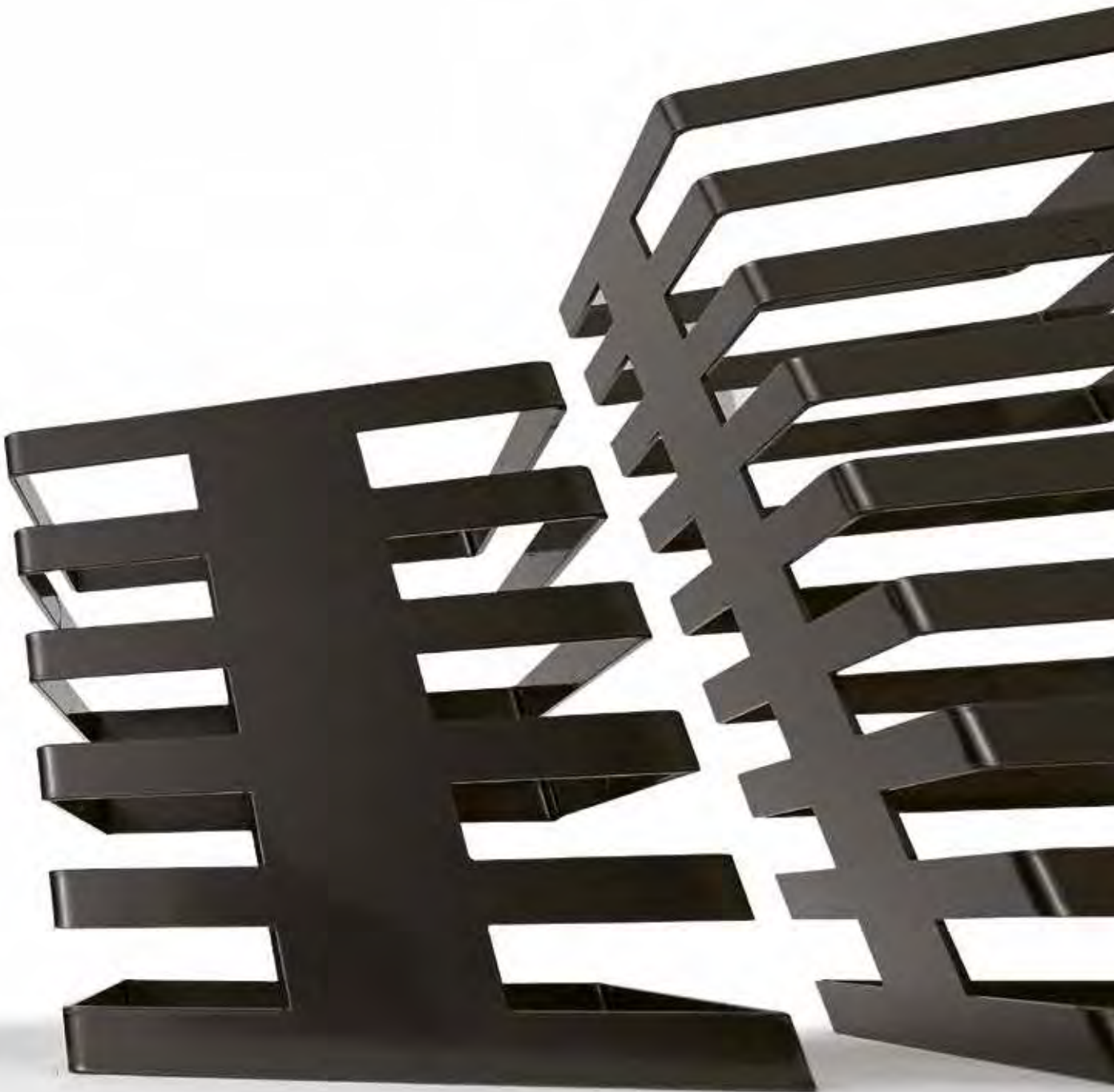

**SET 1**

Urban Tower  
Tower Urban  
Tower Urban  
Urban Tower

<b>V87 32 42 001</b>	Cm	H Cm
	<b>140x42</b>	<b>67</b>
	In	H In
	<b>55,1/8x16,1/2</b>	<b>26,3/8</b>

**SET 4**

Urban Tower  
Tower Urban  
Tower Urban  
Urban Tower

<b>V87 32 42 004</b>	Cm	H Cm
	<b>260x42</b>	<b>67</b>
	In	H In
	<b>102,1/8x16,1/2</b>	<b>26,3/8</b>



**SET 3**

Urban Tower  
Tower Urban  
Tower Urban  
Urban Tower

V87 32 42 003

Cm	H Cm
150x145	67
In	H In
59,1/8x57,1/8	26,3/8

**SET 2**

Urban Tower  
Tower Urban  
Tower Urban  
Urban Tower

V87 32 02 002

Cm	H Cm
140x42	43
In	H In
55,1/8x16,1/2	17



**Tower**

Tower  
Tower  
Tower  
Tower

	Cm	H Cm	In	H In
V87 18 42 001	20x20	10	7,7/8x7,7/8	4
V87 18 42 002	20x20	22	7,7/8x7,7/8	8,5/8
V87 18 42 003	20x20	34	7,7/8x7,7/8	13,3/8
V87 18 42 004	20x20	58	7,7/8x7,7/8	22,7/8

**Modulo a croce**

Cross-shaped extension unit  
Croix  
Verbindungskreuz  
Módulo con forma de cruz

	H Cm	In
V87 18 42 CRO	9,5	3,3/4

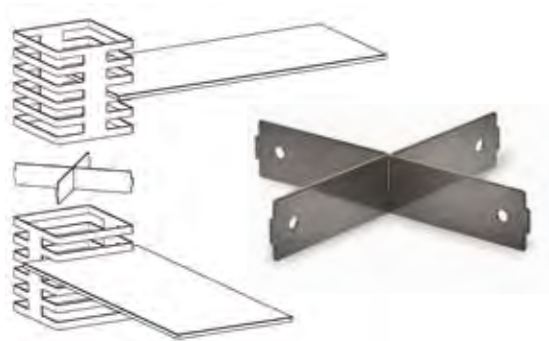
**Scala angolare 4 ripiani**

4-shelf corner ladder  
Étagère angulaire 4 étages  
Eck-Leiter (4 Stufen) Plexiglas  
Escalera angular 4 estantes

	Cm	H Cm	In	H In
V87 12 42 SA2	40x40	10	15,3/4x15,3/4	4

**Coppa quadrata in plexiglass fumé**

Smoky plexiglass salad bowl, square  
Bol plexiglass fumé carrén  
Salatschale Plexiglas viereckig Smoky  
Ensaladera acrílica fumé cuadrada

	Cm	H Cm	In	H In
V87 12 42 C01	34x34	11	13,3/8x13,3/8	4,3/8
V87 12 42 C02	34x34	19	13,3/8x13,3/8	7,1/2

**Piatto quadrato plexiglass fumé**

Smoky plexiglass buffet plate, square  
Plat plexiglass fumé carré  
Buffetplatte Plexiglas viereckig Smoky  
Plato acrílico fumé cuadrado

	Cm	In
V87 12 42 P01	30x30	11,3/4x11,3/4





**Piano in vetro fumé**

Smoky glass top  
 Dessus en verre fumé  
 Glasplatte Smoky  
 Tablero de cristal fumé

	Cm	In
V87 08 42 Q01	30x30	11,3/4x11,3/4
V87 08 42 Q02	42x42	16,1/2x16,1/2
V87 08 42 R01	30x70	11,3/4x27,1/2
V87 08 42 R02	30x100	11,3/4x39,3/8
V87 08 42 R03	42x70	16,1/2x27,1/2
V87 08 42 R04	42x100	16,1/2x39,3/8

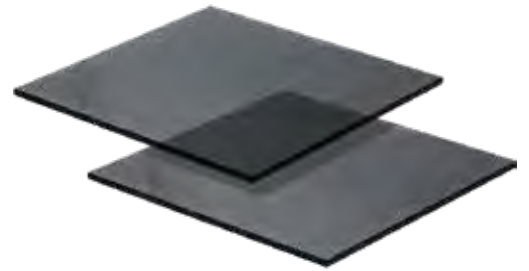
**Piano in ardesia**

Slate top  
 Dessus en ardoise  
 Schieferplatte  
 Tablero de pizarra

	Cm	In
V87 09 42 Q01	30x30	11,3/4x11,3/4
V87 09 42 Q02	42x42	16,1/2x16,1/2
V87 09 42 R01	30x70	11,3/4x27,1/2
V87 09 42 R02	30x100	11,3/4x39,3/8
V87 09 42 R03	42x70	16,1/2x27,1/2
V87 09 42 R04	42x100	16,1/2x39,3/8

**Piano in mdf**

Mdf top  
 Dessus en mdf  
 Mdf Platte  
 Tablero de mdf

	Cm	In
V87 04 42 Q01	30x30	11,3/4x11,3/4
V87 04 42 Q02	42x42	16,1/2x16,1/2
V87 04 42 R01	30x70	11,3/4x27,1/2
V87 04 42 R02	30x100	11,3/4x39,3/8
V87 04 42 R03	42x70	16,1/2x27,1/2
V87 04 42 R04	42x100	16,1/2x39,3/8

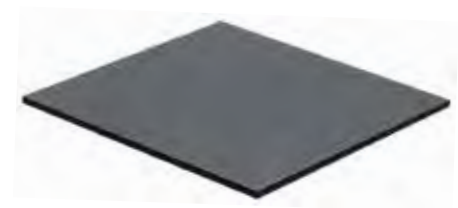
**Totem**

Totem  
 Totem  
 Totem  
 Totem

	Cm	H Cm	In	H In
V87 18 42 T01	29x29	14	11,1/2x11,1/2	5,1/2
V87 18 42 T02	42x42	22	16,1/2x16,1/2	8,5/8



\* Venduto senza ripiano / Sold without shelf

### Scaldavivande da incasso con coperchio in acciaio Inox

Built-in chafing dish with St. Steel cover  
Chafing dish encastrable avec couvercle en acier Inox  
Chafing Dish zum Einbauen mit Edelstahl Deckel  
Chafing dish para empotrar con tapa en acero Inox

	GN	Cm	H Cm
V87 18 52 002	1/1	60,5x40,5	39,5
		In	H In
		23,7/8x16	15,1/2

2 fornelli - 2 burners



**Completo di due fornelli a combustibile solido  
e predisposto per piastra elettrica.  
Portavivande in acciaio incluso**

*With two solid fuel burners,  
electric heating element available.  
With Gastronorm food pan*



### Scaldavivande da incasso con coperchio in acciaio Inox /vetro

Built-in chafing dish with St. Steel / glass cover  
Chafing dish encastrable avec couvercle en acier Inox / verre  
Chafing Dish zum Einbauen mit Edelstahl / Glass Deckel  
Chafing dish para empotrar con tapa en acero Inox / vidrio

	GN	Cm	H Cm
V87 18 52 003	1/1	60,5x40,5	39,5
		In	H In
		23,7/8x16	15,1/2

2 fornelli - 2 burners



**Completo di due fornelli a combustibile solido  
e predisposto per piastra elettrica  
Portavivande in acciaio incluso**

*With two solid fuel burners,  
electric heating element available.  
With GN 1/1 Gastronorm food pan*



### Scaldavivande con gambe e coperchio in acciaio Inox

Chafing dish with St. Steel stand and cover  
Chafing dish avec support et couvercle en acier Inox  
Chafing Dish mit Beinen und Edelstahldeckel  
Chafing dish con soporte y tapa en acero Inox

	GN	Cm	H Cm
V87 18 52 001	1/1	63x42	31
		In	H In
		25,3/4x16,1/2	12,1/4

2 fornelli - 2 burners

	GN	Cm	H Cm
V87 18 52 004	2/3	46x42	32
		In	H In
		18,1/8x16,1/2	12,5/8

1 fornello - 1 burner



**Completo di due fornelli a combustibile solido e predisposto per piastra elettrica. Portavivande in acciaio incluso**

*With two solid fuel burners, electric heating element available. With Gastronorm food pan*



### Scaldavivande con gambe e coperchio acciaio Inox/vetro

Chafing dish with St. Steel/glass stand and cover  
Chafing dish avec support et couvercle en acier Inox / verre  
Chafing Dish mit Beinen und Edelstahl / Glasdeckel  
Chafing dish con soporte y tapa en acero Inox / vidrio

	GN	Cm	H Cm
V87 18 52 005	1/1	63x42	33
		In	H In
		25,3/4x16,1/2	12,1/4

2 fornelli - 2 burners

	GN	Cm	H Cm
V87 18 52 006	2/3	46x42	32
		In	H In
		18,1/8x16,1/2	12,5/8

1 fornello - 1 burner



**Completo di due fornelli a combustibile solido e predisposto per piastra elettrica. Portavivande in acciaio incluso**

*With two solid fuel burners, electric heating element available. With GN 1/1 Gastronorm food pan*

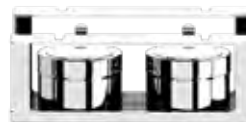

### Caratteristiche tecniche

- A** Asportabilità del coperchio a 90° con estrema facilità.
- B** Coperchio leggero e facilmente maneggiabile.
- C** Blocco automatico dell'estrazione del coperchio in fase di lavoro (da 0° a 89°).
- D** Chiusura e apertura frenata del coperchio. Sistema di cerniere brevettate Abert
- E** Il coperchio si ferma, quando è lasciato, in qualsiasi posizione da 0° a 70°.
- F** Superati i 70° il coperchio si apre completamente lasciandolo andare.
- G** La cerniera è un meccanismo a molla, inalterabile nel tempo, non necessita di regolazione e di manutenzione in quanto non ha frizione.
- H** Tutti i meccanismi sono costruiti in pregiati materiali inossidabili, quindi resistenti alla corrosione, agli ambienti umidi e adatti al contatto con gli alimenti.
- I** Lo scaldavivande è progettato per raccogliere la condensa in modo da lasciare il piano di appoggio completamente asciutto.
- L** Può essere utilizzato sia con riscaldamento elettrico sia con fornelli a combustibile solido.

### Technical characteristics

- A** Easily removable cover, at 90°.
- B** Light and easy-to-handle cover.
- C** Automatic block of cover pull out when in operation (from 0° to 89°).
- D** Closing and opening slowed by cover. Abert patented system.
- E** The cover stops, when released, in any position from 0° to 70°.
- F** Over 70° the cover opens fully when released.
- G** The hinge is a spring mechanism, inalterable in time, it does not need regulation and maintenance as it has no clutch.
- L** All the machineries are built in refined stainless materials, thus resistant to corrosion, humid environment and suitable for food contact.
- I** The chafing dish is designed to collect condensation, in order to keep the support base completely dry.
- L** Both electric warming and solid-fuelburners can be used.

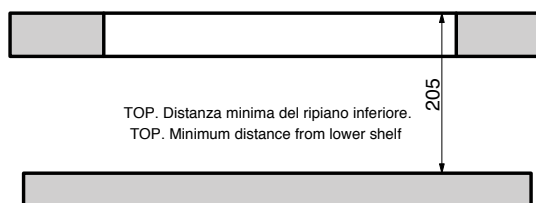
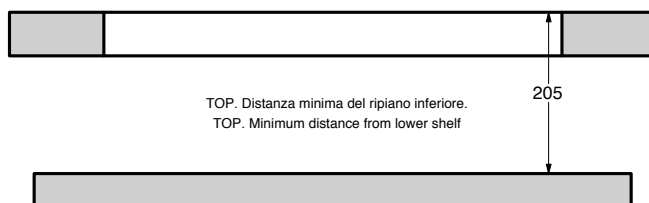
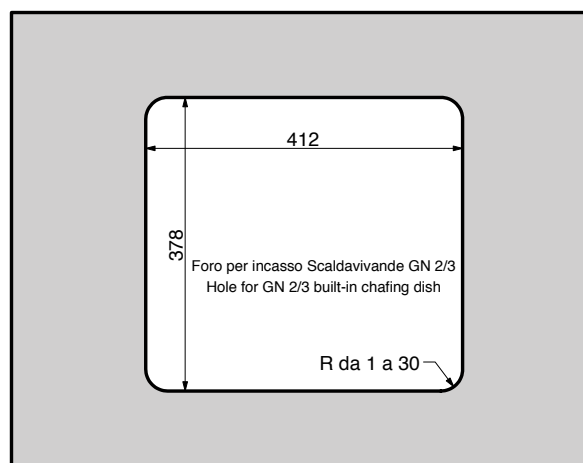
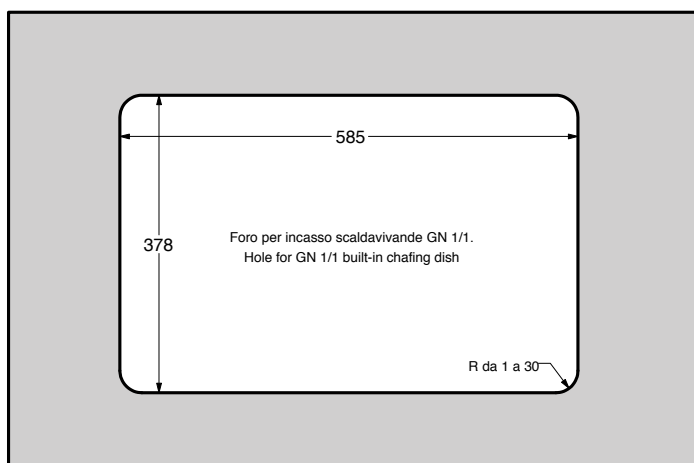





### Scaldavivande GN 1/1 per supporti Urban

GN 1/1 built-in chafing dish  
Chafing dish encastrable GN 1/1  
Eingebautes Chafing Dish GN 1/1  
Chafing dish empotrable GN 1/1

V87 18 520 02 Con coperchio in acciaio Inox - With st. Steel cover  
V87 18 520 03 Con coperchio in vetro - With glass cover

*Predisposto per piastra elettrica. Portavivande GN 1/1 in acciaio incluso. Supporti Urban e fornelli esclusi.*

*Electric heating element available. With GN 1/1 Gastronorm food pan. Urban stand and burners excluded.*



### Coperchio GN 1/1 in acciaio Inox

GN 1/1 St. Steel cover  
Couvercle en acier Inox GN 1/1  
Edelstahldeckel GN 1/1  
Tapa de acero Inox GN 1/1

	H Cm	H In	
B03 05 52 665	7,2	2,3/4	Acciaio inossidabile - St. Steel
G03 05 52 679	7,2	2,3/4	Vetro - Glass



### Inserto GN 1/1 acciaio Inox

GN 1/1 container  
Conteneur GN 1/1  
Gn - Behälter 1/1  
Contenedor GN 1/1

	H Cm	H In
V01 05 72 G11 B	6,5	2,1/2



### Bagnomaria GN 1/1 acciaio Inox

Pan  
Bassine  
Einsatz tief  
Cubeta

	H Cm	H In
305 05 52 666	11	4,3/8



### Fornelletto per scaldavivande

Chafing-dish burner  
Porte brûleur pour chafing dish  
Brennstoffhalter für Chafing Dish  
Contenedor de combustible para chafing dish

V77 05 52 FDC Fornelletto - Burner (Venduto a parte)  
B25 05 52 665 Supporto - Support



### Supporto per set refrigerato

Stand for thermal set  
Support pour set réfrigéré  
Ständer für Thermo-Einsatz  
Soporte para set refrigerado

V87 18 42 PCH7



### Set refrigerato a incastro GN 1/1

GN 1/1 built-in thermal set  
Set réfrigéré encastrable GN 1/1  
Eingebautes Thermo-Einsatz GN 1/1  
Set refrigerado empotrable GN 1/1

**V87 18 520 07** Con coperchio in vetro - With glass cover

Set refrigerato GN 1/1 H7,2 Cm completo di bacinella in acciaio Inox, griglia in acciaio Inox, eutettici, vassoio GN 1/1 HCm 2 in acciaio Inox. Supporti Urban esclusi.

Thermal set GN 1/1 H 7,2 Cm with st. Steel pan, st. Steel grid, ice packs, st. Steel tray GN 1/1 H Cm 2. Urban stand exclude



### Coperchio GN 1/1 in vetro

GN 1/1 glass cover  
Couverche en verre GN 1/1  
Glasdeckel GN 1/1  
Tapa de vidrio GN 1/1

	H Cm	H In
<b>G03 05 52 670</b>	7,2	2,3/4



### Inserto GN 1/1 acciaio Inox

GN 1/1 container  
Conteneur GN 1/1  
Gn - Behälter 1/1  
Contenedor GN 1/1

	H Cm	H In
<b>V01 05 72 G11</b>	2	0,3/4



### Griglia

Grid  
Grille  
Gittereinsatz  
Reja

	H Cm	H In
<b>B4 705 52 668</b>	2	0,3/4



### Eutettico

Ice pack  
Bloc réfrigérant  
Kühlakku  
Acumulador de frío

**V77 12 95 G00**



### Bacinella GN 1/1 acciaio Inox

Pan  
Bassine  
Einsatz tief  
Cubeta

	H Cm	H In
<b>305 05 52 671</b>	7,5	3



### Supporto per set refrigerato

Stand for thermal set  
Support pour set réfrigéré  
Ständer für Thermo-Einsatz  
Soporte para set refrigerado

**V87 18 42 PCH1**

**Inserto GN 1/1**

GN 1/1 container  
 Conteneur GN 1/1  
 Gn - Behälter 1/1  
 Contenedor GN 1/1

**Inox 18/10 - St. Steel**

	Cm	H Cm	Sp. Mm
V01 05 72 G11	53x32,5	2	0,7
V01 05 72 G11 B	53x32,5	6,5	0,7

**Inserto GN 2/3**

GN 2/3 container  
 Conteneur GN 2/3  
 Gn - Behälter 2/3  
 Contenedor GN 2/3

**Inox 18/10 - St. Steel**

	Cm	H Cm	Sp. Mm
V01 05 72 G23	35,4x32,5	2	0,7
V01 05 72 G23 B	35,4x32,5	6,5	0,7

**Inserto GN 1/3**

GN 1/3 container  
 Conteneur GN 1/3  
 Gn - Behälter 1/3  
 Contenedor GN 1/3

**Inox 18/10 - St. Steel**

	Cm	H Cm	Sp. Mm
V01 05 72 G13	32,5x17,6	2	0,7
V01 05 72 G13 A	32,5x17,6	4	0,7

**Inserto GN 1/2**

GN 1/2 container  
 Conteneur GN 1/2  
 Gn - Behälter 1/2  
 Contenedor GN 1/2

**Inox 18/10 - St. Steel**

	Cm	H Cm	Sp. Mm
V01 05 72 G12	32,5x26,5	2	0,7
V01 05 72 G12 B	32,5x26,5	6,5	0,7

**Piastra elettrica**

Electric hot plate  
 Plaque électrique  
 Elektrische Platte  
 Placa eléctrica

V77 05 52 PCR

V77 05 52 PCR1 Con regolatore - With regulator





**Inserto GN 1/1**

Food pan, GN 1/1  
 Conteneur GN 1/1  
 Porzellanbehälter, GN 1/1  
 Contenedor GN 1/1

**Porcellana - Porcelain**

	H Cm	H In
V01 21 52 G11B	6,5	2,1/2
V01 21 52 G11	2	0,3/4

**Inserto GN 2/3**

Food pan, GN 2/3  
 Conteneur GN 2/3  
 Porzellanbehälter, GN 2/3  
 Contenedor GN 2/3

**Porcellana - Porcelain**

	H Cm	H In
V01 21 52 G23B	6,5	2,1/2

**Inserto GN 1/2**

Food pan, GN 1/2  
 Conteneur GN 1/2  
 Porzellanbehälter, GN 1/2  
 Contenedor GN 1/2

**Porcellana - Porcelain**

	H Cm	H In
V01 21 52 G12B	6,5	2,1/2

**Inserto GN 1/3**

Food pan, GN 1/3  
 Conteneur GN 1/3  
 Porzellanbehälter, GN 1/3  
 Contenedor GN 1/3

**Porcellana - Porcelain**

	H Cm	H In
V01 21 52 G13B	6,5	2,1/2

**Piatto piano quadrato**

Square flat plate  
 Assiette carré  
 Teller  
 Plato cuadrado

**Porcellana - Porcelain**

	Cm	H In
V01 21 42 P22	22x22	8,5/8x8,5/8







**Tower**

Tower  
Tower  
Tower  
Tower

**Ferro verniciato - Varnished Iron**

	H Cm	H In
V87 18 42 002	22	8,5/8
V87 18 42 003	34	13,3/8
V87 18 42 004	58	22,7/8

**Contentitore Urban Organizer**

Urban Organizer container  
Conteneur Urban Organizer  
Urban-Organizer Holzbehälter  
Contenedor Urban Organizer

**Legno - Wood**

	Cm	In
V87 04 42 CS1	10x10x8	4x4x3,1/8

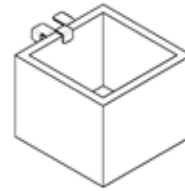
**Contentitore Urban Organizer**

Urban Organizer container  
Conteneur Urban Organizer  
Urban-Organizer Holzbehälter  
Contenedor Urban Organizer

**Legno - Wood**

	Cm	In
V87 04 42 CS2	15x10x46	4x3,1/2

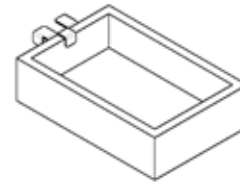
**Contentitore Urban Organizer**

Urban Organizer container  
Conteneur Urban Organizer  
Urban-Organizer Holzbehälter  
Contenedor Urban Organizer

**Legno - Wood**

	Cm	In
V87 04 42 CS3	20x15x4	7,7/8x6x1,1/2
V87 04 42 CS4	20x15x8	7,7/8x6x3,1/8

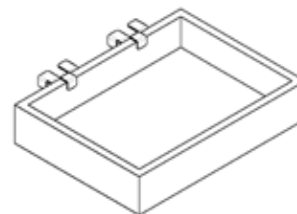
**Contentitore Urban Organizer**

Urban Organizer container  
Conteneur Urban Organizer  
Urban-Organizer Holzbehälter  
Contenedor Urban Organizer

**Legno - Wood**

	Cm	In
V87 04 42 CS5	35x17,5x4	13,3/4x6,7/8x1,1/2
V87 04 42 CS6	35x17,5x8	13,3/4x6,7/8x3,1/8

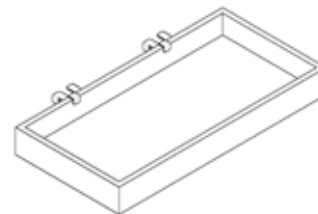
**Contentitore Urban Organizer**

Urban Organizer container  
Conteneur Urban Organizer  
Urban-Organizer Edelstahlbehälter  
Contenedor Urban Organizer

**Inox 18/10 - St. Steel**

	Cm	In
V87 05 42 CS1	6,5x10x4	2,1/2x4x1,1/2

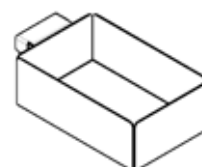

**Contenitore Urban Organizer**

Urban Organizer container  
 Conteneur Urban Organizer  
 Urban-Organizer Edelstahlbehälter  
 Contenedor Urban Organizer

**Inox 18/10 - St. Steel**

	Cm	In
V87 05 42 CS2	10x6,5x4	4x2,2/1x1,1/2

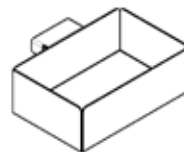
**Contenitore Urban Organizer**

Urban Organizer container  
 Conteneur Urban Organizer  
 Urban-Organizer Edelstahlbehälter  
 Contenedor Urban Organizer

**Inox 18/10 - St. Steel**

	Cm	In
V87 05 42 CS3	18x4,5x4	7x1,3/4 x1,1/2

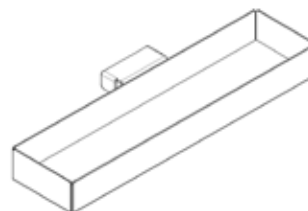
**Contenitore cilindrico per anello**

Cylindrical container for ring  
 Conteneur cylindrique pour anneau  
 Zylindrische Edelstahlbehälter für Ring  
 Contenedor cilíndrico para anillo

**Inox 18/10 - St. Steel**

	Ø Cm	Ø In	H Cm	H In
V87 05 42 CS4	7,6	30	9,5	3,3/4

**Anello Urban Organizer**

Urban Organizer ring  
 Anneau Urban organizer  
 Edelstahlring für Urban-Organizer  
 Anillo Urban Organizer

**Inox 18/10 - St. Steel**

	Ø Cm	Ø In
V87 05 42 A01	9	35,3/8

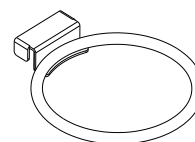
**Base per Tower Urban Organizer verniciata con perni**

Urban Organizer varnished, stand with pins  
 Support Urban Organizer verni avec pivots  
 Lackiert Gestell für Urban Tower, mit Zapfen  
 Soporte Urban Organizer varnizado con pivotes

**Ferro Verniciato - Varnished Iron**

	Cm	In
V87 18 42 B02	30x30	11,3/4x11,3/4

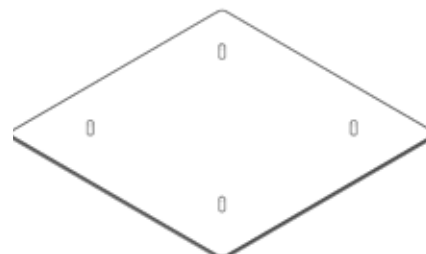
**Vassoio Urban Organizer**

Urban Organizer tray  
 Plateau Urban Organizer  
 Edelstahl Tablett für Urban Organizer  
 Bandeja Urban Organizer

**Inox 18/10 - St. Steel**

	Cm	In
V87 05 42 V01	20x19	7,7/8x7,1/2

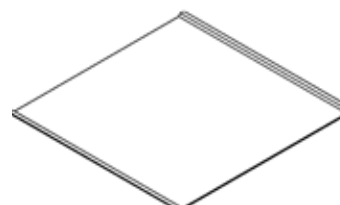





## Revolution

Un'idea nuova ed originale nel concetto Buffet: **Mix&Play Revolution** consente con un tocco di creatività e fantasia di presentare cibi, bevande, stuzzichini ecc. ispirandosi ai diversi momenti di consumo (dalla colazione all'aperitivo) e alle tipologie dei locali. Un'opera d'arte che coniuga modernità e funzionalità in un prodotto che non ha eguali.

Le strutture in alluminio sono state pensate per soddisfare le differenti esigenze di spazio e di consumo del cliente. Sono l'esempio per eccellenza del concetto modulare consentendo la composizione di 5 differenti misure delle basi (2 quadrate e 3 rettangolari) per 3 differenti altezze. Con la creatività è possibile adattare **Mix&Play Revolution** Buffet al proprio spazio e creare sempre nuove ed originali presentazioni.

**7 nuove composizioni studiate per facilitare la creazione del vostro buffet.**

*A new and original idea for the buffet: **Mix&Play Revolution** allows to present food and beverages etc. at different times of the day and different kinds of place, with an incredible touch of creativity and fantasy. A work of art that matches modern day practicality in just one product. The only one!*

*The metal podio are created to satisfy the different needs of space and consumption. They are easy excellent example of modular concept allowing the composition of 5 different sizes of base (2 square and 3 rectangular) for 3 different heights. By being creative it is possible to adapt **Mix&Play Revolution** Buffet to any kind of space and always provide new and fantastic Buffet.*

**7 new arrangements studied to make the preparation of your buffet easier.**

**Set 1**

Set 1  
Set 1  
Set 1  
Set 1

V86 32 42 003 Nero-Black  
V86 32 42 010 Silver-Silver

Cm	H Cm	In	H In
52,5x70	24	20,5/8x27,1/2	9,1/2

**Set 2**

Set 2  
Set 2  
Set 2  
Set 2

V86 32 42 004 Nero-Black  
V86 32 42 011 Silver-Silver

Cm	H Cm	In	H In
35x70	24	13,3/4x27,1/2	9,1/2

**Set 3**

Set 3  
Set 3  
Set 3  
Set 3

V86 32 42 005 Nero-Black  
V86 32 42 012 Silver-Silver

Cm	H Cm	In	H In
52,5x70	22,5	20,5/8x27,1/2	8,7/8

**Set 4**

Set 4  
Set 4  
Set 4  
Set 4

V86 32 42 006 Nero-Black  
V86 32 42 013 Silver-Silver

Cm	H Cm	In	H In
52,5x70	22,5	20,5/8x27,1/2	8,7/8





## Set 5

Set 5  
Set 5  
Set 5  
Set 5

V86 32 42 007 Nero-Black  
V86 32 42 014 Silver-Silver

Cm	H Cm	In	H In
52,5x70	16	20,5/8x27,1/2	6,1/4



## Set 6

Set 6  
Set 6  
Set 6  
Set 6

V86 32 42 008 Nero-Black  
V86 32 42 015 Silver-Silver

Cm	H Cm	In	H In
52,5x52,5	16	20,5/8x20,5/8	6,1/4



## Set 7

Set 7  
Set 7  
Set 7  
Set 7

V86 32 42 009 Nero-Black  
V86 32 42 016 Silver-Silver

Cm	H Cm	In	H In
52,5x52,5	16	20,5/8x20,5/8	6,1/4



**Set Large**

Set Large  
Set Large  
Set Large  
Set Large

V86 32 42 L05 Nero-Black  
V86 32 42 L06 Silver-Silver

Cm	H Cm	In	H In
122,5x87,5	30,5	48,1/4x34,1/2	12

**Set Small**

Set Small  
Set Small  
Set Small  
Set Small

V86 32 42 S05 Nero-Black  
V86 32 42 S08 Silver-Silver

Cm	H Cm	In	H In
87,5x52,5	26,5	34,1/2x20,5/8	10,3/8



## Alzata modulare quadrata

Square modular podium  
Etagère modulaire carrée  
Modulständer, viereckig  
Expositor modular cuadrado

	Cm	H Cm	In	H In
<b>Argento - Silver</b>				
V86 11 42 Q01	17,5x17,5	9,5	6,7/8x6,7/8	3,3/4
V86 11 42 Q02	17,5x17,5	16	6,7/8x6,7/8	6,1/4
V86 11 42 Q03	17,5x17,5	22,5	6,7/8x6,7/8	8,7/8
<b>Nero - Black</b>				
V86 15 42 Q01	17,5x17,5	9,5	6,7/8x6,7/8	3,3/4
V86 15 42 Q02	17,5x17,5	16	6,7/8x6,7/8	6,1/4
V86 15 42 Q03	17,5x17,5	22,5	6,7/8x6,7/8	8,7/8



## Alzata modulare quadrata

Square modular podium  
Etagère modulaire carrée  
Modulständer, viereckig  
Expositor modular cuadrado

	Cm	H Cm	In	H In
<b>Argento - Silver</b>				
V86 11 42 Q04	35x35	9,5	13,3/4x13,3/4	3,3/4
V86 11 42 Q05	35x35	16	13,3/4x13,3/4	6,1/4
V86 11 42 Q06	35x35	22,5	13,3/4x13,3/4	8,7/8
<b>Nero - Black</b>				
V86 15 42 Q04	35x35	9,5	13,3/4x13,3/4	3,3/4
V86 15 42 Q05	35x35	16	13,3/4x13,3/4	6,1/4
V86 15 42 Q06	35x35	22,5	13,3/4x13,3/4	8,7/8



## Alzata modulare rettangolare

Rectangular modular podium  
Etagère modulaire rectangulaire  
Modulständer, rechteckig  
Expositor modular rectangular

	Cm	H Cm	In	H In
<b>Argento - Silver</b>				
V86 11 42 R01	17,5x35	9,5	6,7/8x13,3/4	3,3/4
V86 11 42 R02	17,5x35	16	6,7/8x13,3/4	6,1/4
V86 11 42 R03	17,5x35	22,5	6,7/8x13,3/4	8,7/8
<b>Nero - Black</b>				
V86 15 42 R01	17,5x35	9,5	6,7/8x13,3/4	3,3/4
V86 15 42 R02	17,5x35	16	6,7/8x13,3/4	6,1/4
V86 15 42 R03	17,5x35	22,5	6,7/8x13,3/4	8,7/8



## Alzata modulare rettangolare

Rectangular modular podium  
Etagère modulaire rectangulaire  
Modulständer, rechteckig  
Expositor modular rectangular

	Cm	H Cm	In	H In
<b>Argento - Silver</b>				
V86 11 42 R04	17,5x52,5	9,5	6,7/8x20,5/8	3,3/4
V86 11 42 R05	17,5x52,5	16	6,7/8x20,5/8	6,1/4
V86 11 42 R06	17,5x52,5	22,5	6,7/8x20,5/8	8,7/8
<b>Nero - Black</b>				
V86 15 42 R04	17,5x52,5	9,5	6,7/8x20,5/8	3,3/4
V86 15 42 R05	17,5x52,5	16	6,7/8x20,5/8	6,1/4
V86 15 42 R06	17,5x52,5	22,5	6,7/8x20,5/8	8,7/8



## Alzata modulare rettangolare

Rectangular modular podium  
Etagère modulaire rectangulaire  
Modulständer, rechteckig  
Expositor modular rectangular

	Cm	H Cm	In	H In
<b>Argento - Silver</b>				
V86 11 42 R07	35x52,5	9,5	13,3/4x20,5/8	3,3/4
V86 11 42 R08	35x52,5	16	13,3/4x20,5/8	6,1/4
V86 11 42 R09	35x52,5	22,5	13,3/4x20,5/8	8,7/8
<b>Nero - Black</b>				
V86 15 42 R07	35x52,5	9,5	13,3/4x20,5/8	3,3/4
V86 15 42 R08	35x52,5	16	13,3/4x20,5/8	6,1/4
V86 15 42 R09	35x52,5	22,5	13,3/4x20,5/8	8,7/8



**Piano legno quadrato**

Square wooden base

Tablette en bois carrée

Holzplatte, viereckig

Tablero de madera cuadrado

	Cm	H Cm	In	H In
V86 04 42 PQ1	17,5x17,5	0,8	6,7/8x6,7/8	0,3/8

**Piano legno rettangolare**

Rectangular wooden base

Tablette en bois rectangulaire

Holzplatte, rechteckig

Tablero de madera rectangular

	Cm	H Cm	In	H In
V86 04 42 PR1	17,5x35	0,8	6,7/8x13,3/4	0,3/8

**Supporto legno inclinato quadrato**

Square modular podium

Etagère modulaire carrée

Holzgestell, viereckig, schräg gestellt

Expositor modular cuadrado

	Cm	H Cm	In	H In
V86 04 42 SQ1	35x35	7,5	13,3/4x13,3/4	3

**Supporto legno inclinato rettangolare**

Rectangular modular podium

Etagère modulaire rectangulaire

Holzgestell, viereckig, schräg gestellt

Expositor modular rectangular

	Cm	H Cm	In	H In
V86 04 42 SR1	35x52,5	7,5	13,3/4x20,5/8	3



## Vassoio legno quadrato

Square wooden tray  
 Plateau en bois carrée  
 Holztablett, viereckig  
 Bandeja de madera cuadrado

	Cm	H Cm	In	H In
V86 04 42 VQ1	35x35	4	13,3/4x13,3/4	1,1/2
V86 04 42 VQ2	35x35	8	13,3/4x13,3/4	3,1/8



## Vassoio legno rettangolare

Rectangular wooden tray  
 Plateau en bois rectangulaire  
 Holztablett, rechteckig  
 Bandeja de madera rectangular

	Cm	H Cm	In	H In
V86 04 42 VR1	17,5x35	4	6,7/8x13,3/4	1,1/2
V86 04 42 VR2	17,5x35	8	6,7/8x13,3/4	3,1/8



## Vassoio legno rettangolare

Rectangular wooden tray  
 Plateau en bois rectangulaire  
 Holztablett, rechteckig  
 Bandeja de madera rectangular

	Cm	H Cm	In	H In
V86 04 42 VR3	17,5x52,5	4	6,7/8x20,5/8	1,1/2
V86 04 42 VR4	17,5x52,5	8	6,7/8x20,5/8	3,1/8



## Vassoio legno rettangolare

Rectangular wooden tray  
 Plateau en bois rectangulaire  
 Holztablett, rechteckig  
 Bandeja de madera rectangular

	Cm	H Cm	In	H In
V86 04 42 VR5	35x52,5	4	13,3/4x20,5/8	1,1/2
V86 04 42 VR6	35x52,5	8	13,3/4x20,5/8	3,1/8



**Piatto quadrato porcellana**

Square porcelain platter  
 Plat carré en porcelaine  
 Porzellanteller, viereckig  
 Plato cuadrado de porcellana

	Cm	In
V86 21 42 PQP	17,5x17,5	6,7/8x6,7/8

**Piatto quadrato porcellana**

Square porcelain platter  
 Plat carré en porcelaine  
 Porzellanteller, viereckig  
 Plato cuadrado de porcellana

	Cm	In
V86 21 42 PQG	35x35	13,3/4x13,3/4

**Piatto rettangolare porcellana**

Rectangular porcelain platter  
 Plat rectangulaire en porcelaine  
 Porzellanteller, rechteckig  
 Plato rectangular de por

	Cm	In
V86 21 42 PRE	17,5x35	6,7/8x13,3/4

**Teglia rettangolare in porcellana**

Rectangular porcelain baker  
 Plate a roti rectangular en porcelaine  
 Porzellanbackform, rechteckig  
 Fuente rectangular porcelana

	Cm	In
V86 21 42 TRE	17,5x35	6,7/8x13,3/4

**Teglia quadrata in porcellana**

Square porcelain baker  
 Plate a roti carré en porcelaine  
 Porzellanbackform, viereckig  
 Fuente cuadrada de porcelana

	Cm	In
V86 21 42 TQU	35x35	13,3/4x13,3/4



## Ciotola quadra porcellana

Porcelain bowl  
Bol carré en porcelaine  
Porzellanschale, viereckig  
Bol cuadrado de porcellana

	Cm	H Cm	In	H In
V86 21 42 CQ14	14x14	8	5,1/2x5,1/2	3,1/8



## Ciotola quadra porcellana

Porcelain bowl  
Bol carré en porcelaine  
Porzellanschale, viereckig  
Bol cuadrado de porcellana

	Cm	H Cm	In	H In
V86 21 42 CQ7	7x7	3,5	2,3/4x2,3/4	1,3/8



## Bicchieri vetro basso

Glass glass, small  
Verre Ginco  
Glass, klein  
Vaso cristal bajo

	∅ Cm	H Cm	Lt
V86 08 42 BBA	6	8	0,10
	∅ In	H In	Oz
	2,3/8	3,1/8	3,5



## Bicchieri vetro alto

Glass glass, tall  
Verre en verre haut  
Glass, hoch  
Vaso cristal alto

	∅ Cm	H Cm	Lt
V86 08 42 BAL	7	11	0,15
	∅ In	H In	Oz
	2,3/4	4,3/8	5



## Coppa in vetro

Glass bowl  
Coupelle en verre  
Glasschale  
Bol de vidrio

	∅ Cm	H Cm	∅ In	H In
V86 08 42 C12	12	7	4,3/4	2,3/4



**Set ABS**

Set 1

Set 1

Set 1

Set 1

	Cm	H Cm	In	H In
V86 32 42 S06 Nero-Black	87x52,5	23	34,1/4x20,5/8	9
V86 32 42 S07 Silver-Silver	87x52,5	23	34,1/4x20,5/8	9





**Piano in ABS nero quadrato liscio**

Square plain black ABS base

Plat carré en abs noir

ABS Platte, schwarz viereckig und glatt

Base en ABS negra cuadrada lisa

	Cm	In
V86 12 42 QLI 15	17,5x17,5	6,7/8x6,7/8

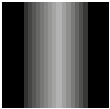
**Piano in ABS nero rettangolare liscio**

Rectangular plain black ABS base

Plat rectangulaire en ABS noir

ABS Platte, schwarz rechteckig und glatt

Base en ABS negra cuadrada lisa

	Cm	In
V86 12 42 RLI 15	17,5x35	6,7/8x13,3/4

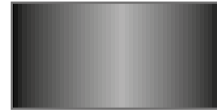
**Piano abs nero quadrato 1 foro grande**

Square Abs base with 1 hole

Plat carré en abs noir 1 trou grand

ABS Platte, schwarz mit einem Loch

Base en ABS negra con 1 agujero grande

	Cm	In
V86 12 42 Q1F 15	17,5x17,5	6,7/8x6,7/8

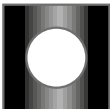
**Piano abs nero rettangolare 2 fori grandi**

Rectangular Abs base with 2 holes

Plat rectangulaire en ABS noir 2 trous grands

ABS Platte, schwarz rechteckig und mit 2 großen Löcher

Base en ABS negra rectangular, con 2 agujeros grandes

	Cm	In
V86 12 42 R2F 15	17,5x35	6,7/8x13,3/4

**Piano abs nero quadrato 4 fori piccoli**

Square Abs base with 4 holes

Plat carré en ABS noir 4 trous petits

ABS Platte, schwarz viereckig mit 4 kleinen Löcher

Base en ABS negra cuadrada con 4 agujeros pequeños

	Cm	In
V86 12 42 Q4F 15	17,5x17,5	6,7/8x6,7/8

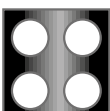
**Piano abs nero rettangolare 8 fori piccoli**

Rectangular Abs base with 8 holes

Plat rectangulaire en ABS noir 8 trous petits

ABS Platte, schwarz viereckig mit 8 kleinen Löcher

Base en ABS negra rectangular, con 8 agujeros pequeños

	Cm	In
V86 12 42 R8F 15	17,5x35	6,7/8x13,3/4

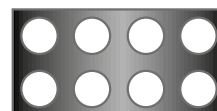

**Distributore succhi**

Juice dispenser  
Distributeur jus  
Saftdispenser  
Dispensador de zumo

**Con rubinetto in metallo**

With metal tap  
Avec robinet en métal  
Mit Metallhahn  
Con grifo de metal

	Lt	Oz	Cm	H Cm	In	H In
V76 05 52 00 8R	3,5	118	20x31,5	51	7,3/4x12,1/2	20
V76 05 52 00 2R	7	237	27x37	56	10,5/8x14,1/2	22
V76 05 52 01 2R	12	405	27x37	51	10,5/8x14,1/2	20

**Con rubinetto in plastica**

With plastic tap  
Avec robinet en plastique  
Mit Kunststoffhahn  
Con grifo de plástico

	Lt	Oz	Cm	H Cm	In	H In
V76 05 52 00 9R	3,5	118	20x31,5	51	7,3/4x12,1/2	20
V76 05 52 00 3R	7	237	27x37	56	10,5/8x14,1/2	22
V76 05 52 01 3R	12	405	27x37	51	10,5/8x14,1/2	20

**Portaformaggi-affettati rettangolare refrigerato**

Thermal rectangular cheese dish  
Plateau fromage - charcuterie rectangulaire réfrigérant  
Rechteckige Aufschnittplatte, gekühlt  
Quesera rectangular refrigerante

	Cm	H Cm	In	H In
V76 05 54 R0 1R	50x30	20	19,3/4x11,3/4	7,7/8





## Distributore caffè

Coffee urn  
Distributeur de café  
Kaffeedispenser  
Dispensador de café

	Lt	Cm	HCm
<b>V76 05 52 00 1R</b>	<b>10</b>	<b>26x33</b>	<b>64</b>
	Oz	In	H In
	<b>350</b>	<b>10,1/4x13</b>	<b>25,1/8</b>



## Distributore cereali singolo

Cereal dispenser  
Distributeur céréales  
Müeslidispenser  
Dispensador de cereales

	Lt	Cm	HCm
<b>V76 05 52 01 0R</b>	<b>4</b>	<b>19,5x29</b>	<b>56</b>
	Oz	In	H In
	<b>135</b>	<b>7,3/4x11,3/8</b>	<b>22</b>

	Lt	Cm	HCm
<b>V76 05 52 01 1R</b>	<b>7</b>	<b>19,5x29</b>	<b>70</b>
	Oz	In	H In
	<b>237</b>	<b>7,3/4x11,3/8</b>	<b>27,7/8</b>





# BUFFET SQUARE

## Portaformaggi-affettati rettangolare refrigerato Square

Thermal rectangular cheese dish Square

Plateau fromage-charcuterie rectangulaire réfrigérant Square

Rechteckige Aufschnittplatte, gekühlt, Square

Quesera rectangular refrigerante Square

### Inox 18/10 - St. Steel

	Cm	H Cm	In	H In
V76 05 54 R01	50x30	20	19,5/8x11,7/8	7,7/8



### Coperchio a bascula rettangolare trasparente

Transparent rectangular rolltop cover

Cloche basculante rectangulaire transparente

Rolltophaube-rechteckig

Campana rectangular transparente

### SAN

	Cm	In
V76 12 15 R01	47x27	18,1/2x10,5/8

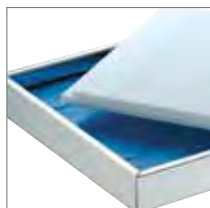

### Tagliere rettangolare

Rectangular cutting board

Planche à découper rectangulaire

Rechteckiges Schneidebrett

Tabla de cortar rectangular

### Polietilene

	Cm	In
V77 12 71 R01	47x27	18,1/2x10,5/8



### 4 Eutettici rettangolari

4 Ice packs

4 Blocs réfrigérants

4 Kühlakkus

4 Acumuladores de frío rectangulares

V77 12 95 M00

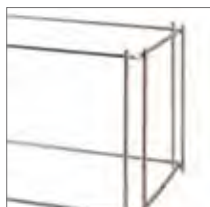

### Alzata filo per basi rettangolari

Square wire stand for rectangular bases

Support en fil pour bases rectangulaires

Drahtständer für rechteckigen Sockel

Soporte filo de acero para bases rectangulares

### Inox 18/10 - St. Steel

	Cm	H Cm
V76 05 42 001	50x30	27,5

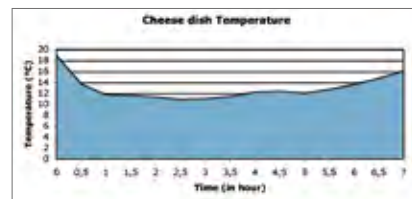

Temperatura ambiente  
External temperature

19,6°

Temperatura acqua  
Water temperature

18,9°

Mezzo refrigerante  
Cooler system

8 eutettici ghiaccio piccoli  
8 small ice packs

## Portaformaggi-affettati tondo refrigerato Square

Thermal round cheese dish Square

Plateau fromage-charcuterie rond réfrigérant Square

Runde Aufschnittplatte, gekühlt, Square

Quesera redonda refrigerante Square

**Inox 18/10 - St. Steel**

	Cm	H Cm	In	H In
V76 05 54 T01	38x38	23	14,8/8x14,8/8	9



### Coperchio a bascula tondo trasparente

Transparent round rolltop cover

Cloche basculante ronde transparente

Rolltophaube - rund

Campana redonda transparente

**SAN**

	ø Cm	ø In
V76 12 15 T01	34	13,3/8



### Tagliere quadrato con scanal. tonda

Square cutting board with round groove

Planche à découper carrée avec rainure ronde

Viereckiges Schneidebrett mit runder Rille

Tabla de cortar cuadrada con ranura

**Polietilene**

	Cm	In
V77 12 71 T01	35x35	13,3/4x13,3/4



### Eutettici rettangolari

Ice packs

Blocs réfrigérants

Kühlakkus

Acumuladores de frío rectangulares

V77 12 95 M00

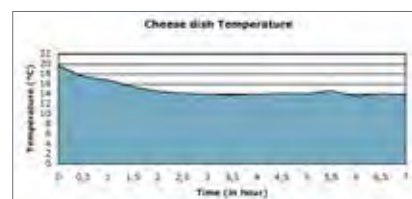

Temperatura ambiente  
External temperature 20,9°

Temperatura acqua  
Water temperature 19,5°

Mezzo refrigerante  
Cooler system 4 eutettici ghiaccio piccoli  
4 small ice packs

**Distributore succhi Square**

Square juice dispenser

Distributeur jus Square

Saftdispenser Square

Dispensador de zumo Square

**Con rubinetto in metallo**

With metal tap

Avec robinet en métal

Mit Metallhahn

Con grifo de metal

	Cm	H Cm	Lt	Oz
V76 05 52 008	18x27,5	46	3,5	118
V76 05 52 002	24x31	50	7	237
V76 05 52 012	24x31	70	12	405

**Con rubinetto in plastica**

With plastic tap

Avec robinet en plastique

Mit Kunststoffhahn

Con grifo de plástico

	Cm	H Cm	Lt	Oz
V76 05 52 009	17,5x27,5	41	3,5	118
V76 05 52 003	23,5x31	50	7	237
V76 05 52 013	23,5x31	78	12	405

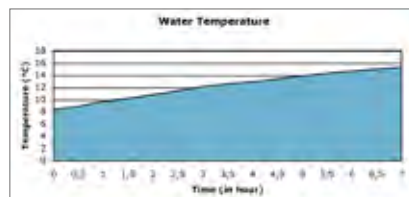

Temperatura ambiente  
External temperature 20,0°

Temperatura acqua  
Water temperature 7,6°

Quantità acqua inserita  
Quantity of water added 7 Lt



## Distributore caffè Square

Coffee urn 10 Lt  
 Distributeur de café 10 Lt  
 Kaffeedispenser 10 Lt  
 Dispensador de café 10 Lt

	Cm	H Cm	Lt	Oz
V76 05 52 001	24x31	61	10	350



### Fornelletto per scaldavivande / distributore caffè

Burner for chafing dish/coffee urn  
 Porte bruleur pour chafing dish et distributeur café  
 Brennstoffhalter für Chafing Dish und Kaffeedispenser  
 Contenidor de combustible para chafing dish - dispensador de café

V77 05 52 FDC



### Piastra elettrica per distributore caffè

Heating element for coffee urn  
 Plaque électrique pour distributeur de café  
 Elektro-Heizelement für Kaffeedispenser  
 Plancha eléctrica para dispensador de café

	ø Cm	ø In
V77 05 52 PDC	14	5,1/2

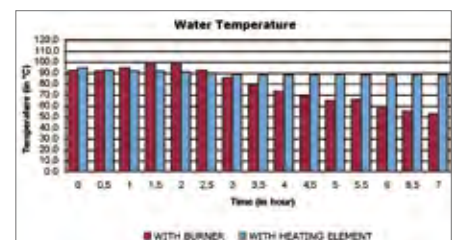

Temperatura ambiente  
 External temperature 20,0°

Temperatura acqua  
 Water temperature 92,5°/98,8°

Quantità acqua inserita  
 Quantity of water added 8 Lt

**Distributore cereali singolo Square**

Square cereal dispenser

Distributeur céréales Square

Mueslidispenser Square

Dispensador de cereales Square

	Cm	H Cm	Lt	Oz
V76 05 52 010	18x27	53	4	135
V76 05 52 011	18x27	68	7	237



## Tagliere per pane base acciaio Square

Square bread cutting board with St. Steel base  
 Plaque à découper à pain Square avec base en acier Inoxidable  
 Brotschneidebrett Square mit Stahlgestell  
 Tabla de cortar pan Square con base de acero Inoxidable

	Cm	In
V76 05 54 001	50x30	19,5/8x11,7/8

**V76 04 71 001**    **50x30**    **19,5/8x11,7/8**  
 Solo tagliere

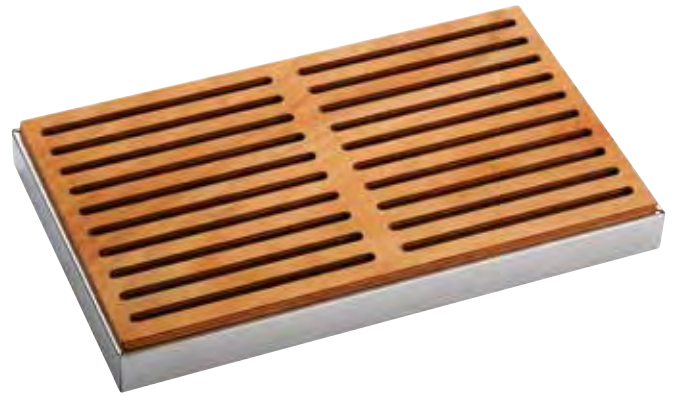

## Cestino pane acciaio per buffet Square

Square bread basket for buffet, St. Steel  
 Corbeille à pain en acier pour buffet Square  
 Brotkorb Square für Buffet, Edelstahl  
 Cesta pan en acero para buffet Square

	Cm	In
V76 05 24 001	50x30	19,5/8x11,7/8



## Scaldabrioche Square con termostato

Square croissant warmer  
 Chauffe - croissants Square  
 Croissantwärmer Square  
 Calentador croissants Square

	Cm	In
V76 05 52 020	47,5x28	18,3/4x11



**Portamacedonia Square**

Square yogurt/fruit-salad holder without lid  
 Porte-salade de fruits/yogourt sans couvercle Square  
 Joghurt/Obstsalatbehälter ohne Deckel Square  
 Porta yogur/ensalada de frutas refrigerado sin tapa Square

	Cm	In
V76 05 52 017	24x24	6,7/8x6,7/8

Con coperchio - with lid

V76 05 52 007	24x24	6,7/8x6,7/8
---------------	-------	-------------

Senza coperchio - without lid

**Coperchio metacrilato c/pomolo Square**

Acrylic lid with knob Square  
 Couvercle acrylique avec pommeau Square  
 Deckel aus Acryl mit Knopf Square  
 Tapa acrílica con perilla Square

310 12 15 797

**Ciotola in vetro**

Glass bowl  
 Bol en verre  
 Glasschale  
 Bol de vidrio

	ø Cm	ø In
310 08 42 527	23	9

**Disco copri eutettici**

Ice pack cover  
 Disc pour blocs réfrigérants  
 Disco para acumuladores de frío  
 Kühlakkus Scheibe

	ø Cm	ø In
Z76 60 52 007	24	9,1/2

**Eutettici rettangolari**

Ice packs  
 Blocs réfrigérants  
 Abdeckungscheibe für Kühlakkus  
 Acumuladores de frío rectangulares

V77 12 95 M00

**Contenitore in metallo porta macedonia /eutettico Square**

Square metal fruit salad holder 24x24 Cm w/o ice pack  
 Conteneur en métal pour salade de fruits sans bloc réfrigérant Square  
 Metalbehälter ohne Kühlakkus Square  
 Porta ensalada de frutas en metal Square sin acumuladore de frío

Z76 20 52 007



## Portayogurt/marmellata refrigerato Square

Square thermal yogurt/jam holder for pitcher  
 Rafrâchisseur yaourt/confiture Square  
 Joghurt/Marmeladebehälter, gekühlt Square  
 Portayogur/mermelada refrigerado Square

	∅ Cm	∅ In
V76 05 52 014	15	6

Con coperchio - with lid

V76 05 52 004	15	6
---------------	----	---

Senza coperchio - without lid



## Coperchio porta yogurt c/pomolo Square

Square lid with knob for yogurt holder  
 Couvercle sans pomole pour porte-yaourt Square  
 Deckel für Joghurtbehälter Square  
 Tapa para portayogur sin perilla Square

	∅ Cm	∅ In
Z76 01 52 004	4	1,1/2



## Ciotola in vetro

Glass bowl  
 Bol en verre  
 Glasschale  
 Bol en vidrio

	∅ Cm	∅ In	Lt	Oz
V76 08 52 004	15	6	0,5	17



## Disco copri eutettici

Ice pack cover  
 Disc pour blocs réfrigérants  
 Kühlakku Scheibe  
 Disco para acumuladores de frío

	∅ Cm	∅ In
Z76 60 52 005	15	6



## Eutettici tondi

Round ice packs  
 Blocs réfrigérants ronds  
 Abdeckungscheibe für Kühlakku  
 Acumuladores de frío rectangulares

	∅ Cm	∅ In
V77 12 95 T01	14,5	5,3/4



## Contenitore in metallo porta caraffe/yogurt s/eutettico Square

Square pitcher/yogurt holder without ice pack  
 Conteneur en métal pour carafes/yaourt sans bloc réfrigérant Square  
 Metalbehälter ohne Kühlakku Square  
 Portayogur/jarra sin acumulador de frío Square

	Cm	H Cm	In	H In
Z76 20 52 004	17,5x17,5	7	6,7/8x6,7	3,3/4



**Portacaraffa con coperchio refrigerato Square**

Square thermal pitcher holder with lid  
 Porte-carafe avec couvercle réfrigérant Square  
 Karaffenträger mit Deckel, gekühlt Square  
 Soporte refrigerado para jarra con tapa Square

	Lt	Oz
V76 05 52 005	1,5	50

Con coperchio-with lid

V76 05 52 006	1,5	50
---------------	-----	----

Senza coperchio-without lid

**Coperchio caraffa in acciaio per brocca**

St. Steel lid for juice pitcher  
 Couvercle en acier pour carafe  
 Edelstahl Deckel für Karaffe  
 Tapa en acero para jarra

	∅ Cm	∅ In
Z76 01 52 005	10	4

**Caraffa vetro**

Glass pitcher  
 Carafe en verre  
 Saftkanne  
 Jarra de zumo

	Lt	Oz
V76 08 52 009	1,5	50

Senza coperchio-without lid

V76 08 52 005	1,5	50
---------------	-----	----

Con coperchio-with lid

**Disco copri eutettici**

Ice pack cover  
 Disc pour blocs réfrigérants  
 Kühlakkus Scheibe  
 Disco para acumuladores de frío

	∅ Cm	∅ In
Z76 60 52 005	15	6

**Eutettici tondi**

Round ice packs  
 Blocs réfrigérants ronds  
 Kühlakkus rund  
 Acumuladores de frío rectangulares

	∅ Cm	∅ In
V77 12 95 T01	14,5	5,3/4

**Contenitore in metallo porta caraffe/yogurt s/eutettico Square**

Square pitcher/yogurt holder w/o ice pack  
 Conteneur en métal pour carafes/yaourt sans bloc réfrigérant Square  
 Metalbehälter ohne Kühlakkus Square  
 Portayogurt/jarra sin acumulador de frío Square

	Cm	H Cm	In	H In
Z76 20 52 004	17,5x17,5	7,5	6,7/8x6,7	3



## Portacaraffe con sistema refrigerante

Thermal pitcher 4-pc set  
 Rafrâchisseur à 4 carafes  
 Thermo-Karaffenhälter 4 Stck.  
 Enfriador para 4 jarras

### Inox 18/10 - St. Steel

	Cm	H Cm	In	H In
V76 05 52 021	24x24	7,5	9,1/2x9,1/2	3

Caraffe non incluse - Water jugs not included



## Caraffa acqua con coperchio basculante

Water glass pitcher with smart lid  
 Carafe en verre avec couvercle basculant  
 Wasserkaraffe  
 Jarra de vidrio con tapa basculante

	Lt	Oz
● V76 08 52 007	1	35
● V76 08 52 007 35	1	35
● V76 08 52 007 07	1	35

**Rinfresca caraffe con sistema refrigerante**

Thermal pitcher

Rafraîchisseur à carafes

Thermo-Karaffenhalter

Enfriador de botallas

**Inox 18/10 - St. Steel**

	ø Mm	H Cm	ø In	H In
V76 055 20 23	135	5	5,3/8	2

con eutettico - with ice pack

caraffa esclusa - without pitcher

**Eutettico per rinfresca caraffe**

Ice pack for thermal pitcher

Bloc réfrigérant pour rafraîchisseur à carafes

Kühlelemente für Thermo-Karaffenhalter

Acumulador de frío para enfriador de botellas

**Polietilene - Polyethylene**

	ø Mm	H Cm	ø In	H In
V77 12 95 T02	75	2,5	3	1

**Corpo per porta caraffa**

Container for thermal pitcher

Conteneur pour rafraîchisseur à carafes

Behälter für Thermo-Karaffenhalter

Contenedor para enfriador de botellas

**Polietilene - Polyethylene**

	ø Mm	H Cm	ø In	H In
Z76 20 52 023	135	5	5,3/8	2





## Contenitore alto per struttura piramidale

Container for pyramid buffet system  
Conteneur haut pour structure pyramidale  
Behälter für pyramidal Gestell  
Contenedor alto para estructura piramidal

	Cm	H Cm	In	H In
V76 05 23 006	7x9,5	6	2,3/4x3,3/4	2,3/8



## Cucchiaino appetizer tondo

Appetizer curved spoon  
Cuillère de mise en bouche ronde pliée  
Appetizer - rund gebogener Löffel  
Cuchara aperitivo redonda plegada

Inox 18/10 - St. Steel

	Cm	In
903 05 81 APC	140	5,1/2



## Ciotola porcellana quadra

Porcelain square bowl  
Bol carré en porcelaine  
Porzellanschale, viereckig  
Bol cuadrado en porcelana

	Cm	In
V86 21 42 CQ7	7x7	2,3/4x2,3/4



## Bicchieri

Glass  
Verre  
Glas  
Vaso

	ø Cm	H Cm	ø In	H In
V86 08 42 BBA	5,5	7	2,1/8	2,3/4



## Struttura piramidale

### completa di 5 ripiani e 3 contenitori alti.

Pyramid buffet system including 5 bases and 3 containers  
Structure pyramidale complète avec 5 bases e 3 conteneurs  
Pyramidal Gestell komplet bestehend von 5 Fächer und 3 hoch Behälter  
Estructura piramidal completa con 5 bases y 3 contenedores

	Cm	H Cm	In	H In
V76 05 42 006	29,5x36,5	50	11,3/4x14,1/2	19,3/4



## Piano rettangolare per struttura piramidale

Rectangular base for pyramid buffet system  
Plan rectangulaire pour structure pyramidale  
Rechteckig Fach für pyramidal Gestell  
Base rectangular para estructura piramidal

	Cm	In
V76 05 23 005	29,5x7	11,5/8x2,3/4





Un oggetto **elegante e contemporaneo**, adatto a ogni tipo di buffet: grazie al design unico e innovativo.

I materiali usati sono di **alto livello qualitativo** - acciaio Inox 18/10 e metacrilato - e rendono il distributore un oggetto pregiato.

**MADE IN ITALY**

La **tecnologia semplice**, ma al tempo stesso funzionale, permette di erogare dosi da 8gr (0.28 oz) di prodotto, riducendo gli sprechi ed eliminando le monoporzioni da 25gr (0.88 oz).

Questo consente un risparmio di prodotto e la riduzione dei rifiuti

nel rispetto dell'ambiente. Inoltre è ideale per servire miele e marmellate di produzione artigianale, per fornire un prodotto di alto livello e che soddisfi anche i clienti più esigenti.

Un ottimo modo per arricchire l'esperienza della colazione, mantenendo **ordinato e pulito** il buffet.

Utilizzabile con prodotti erogabili semisolidi, come confetture, marmellate - pure con piccoli frammenti di frutta - e creme, ma anche con miele, sciroppi e salse di analoga consistenza.

Jambee è l'ideale per **ogni struttura ricettiva**: alberghi, pasticcerie, bar e ristoranti.



An **elegant and modern** object for all buffets, thanks to its unique and innovative design.

The materials used are **high quality** – 18/10 stainless steel and methacrylate – which makes the dispenser a fine object.

**MADE IN ITALY**

Its **simple technology**, though functional, allows to dispense 8 gr (0.28 oz) product doses, to reduce waste and get rid of 25 gr (0.88 oz) single dose jars.

That allows, as well, to save on product and reduce waste, respecting the environment.

Moreover, it is the ideal to dispense honey and homemade jams, in order to supply for a high-end product, capable of meeting even the most demanding customers' needs.

The best way to make the most of the breakfast experience, keeping the buffet **tidy and clean**.

It can be used with dispensable semisolid products like preserves, marmalades – even with small fruit pieces in them – , creams and honey, syrups and sauces as well, which have the same consistency. Jambee is the ideal for **any accommodation facility**: hotels, pastry shops, bars and restaurants.

**Pistone con coperchio**

Piston with lid

Piston avec couvercle

Kolben mit Deckel

Pistón con tapa

**Inox 18/10, Metacrilato e PP - St. Steel, Methacrylate and PP**

Lt

**Z77 9852 DMA** 0,7**Z77 9852 DMA1** 1**Contentitore**

Container

Conteneur

Behälter

Contenedor

**Metacrilato - Methacrylate**

Lt

**Z77 2052 DMA** 0,7**Z77 2052 DMA1** 1**Tappo**

Cap

Capsule

Stöpsel

Tapón

**Metacrilato - Methacrylate****Z77 1352 DMA****Contentitore completo**

Complete container

Conteneur complet

Komplett Behälter

Contenedor completo

**Metacrilato - Methacrylate**

Lt

**Z77 9952 DMA** 0,7**Z77 9952 DMA1** 1**Targhetta porta etichetta**

Label plate

Plaque porte-étiquette

Schild Etikettenhalter

Placa porta etiqueta

**Metacrilato - Methacrylate****Z77 5752 DMA****Targhetta porta etichetta**

Label plate

Plaque porte-étiquette

Schild Etikettenhalter

Placa porta etiqueta

**Metacrilato - Methacrylate****Z77 5752 DMA1**

## Jambee

Jambee  
Jambee  
Jambee  
Jambee

### Acciaio Inox 18/10 - St. Steel

	Lt	Oz	Cm	In
V77 0552 DMB	0,7	24	12,5x34,5 H Min 44,5 H Max 58	5x13,5/8 H Min 17,1/2 H Max 22,7/8
V77 0552 DMC	1	35	12,5x34,5 H Min 48 H Max 71,5	5x13,5/8 H Min 18,3/4 H Max 28,1/8



### Erogatore a siringa

Syringe nozzle  
Embout seringue  
AusgieBerspritze  
Boquilla jeringa

### Inox 18/10 - St. Steel

Z77 4652 DMA



### Erogatore standard

Standard nozzle  
Embout standard  
Standard AusgieBer  
Boquilla estandar

### Inox 18/10 - St. Steel

Z77 4552 DMA

# BUFFET IMPERIAL





**Portaformaggi/affettati rettangolare completo**

Rectangular cheese dish

Plateau fromage-charcuterie rectangulaire

Käse/Wurstwarenplatte - rechteckig

Quesera rectangular

	Cm	H Cm	In	H In
V77 05 54 G11	53x32,5	18	20,7/8x12,3/4	7

**Coperchio a bascula trasparente**

Transparent rolltop cover

Cloche basculante transparente

Rolltophaube

Campana rolltop transparente

	Cm	In
V77 12 15 G11	47x27	18,1/2x10,5/8

**Vassoio gastronorm**

Gastronorm tray

Plateau gastronorm

Gastronorm Platte

Bandeja gastronorm

	Cm	In
V01 05 23 G11	53x32,5	20,7/8x12,3/4

**Tagliere rettangolare**

Rectangular cutting board

Planche rectangulaire

Rechteckig-Schneidebrett

Tabla para cortar rectangular

**Polietilene**

	Cm	In	Sp. Mm	Th. In
V77 12 71 G11	47x27	18,1/2x10,5/8	1,5	0,5/8



## Portaformaggi/affettati tondo completo

Round cheese dish

Plateau fromage-charcuterie rond

Käse/Wurstwarenplatte - rund

Quesera redonda

	ø Cm	H Cm	ø In	H In
V77 05 54 T46	46	24,5	18,1/8	9,5/8



### Coperchio a bascula tondo trasparente

Transparent round rolltop cover

Cloche basculante ronde transparente

Rolltophaube - rund

Campana rolltop redonda transparente

	ø Cm	ø In
V77 12 15 T46	41	16,1/8



### Vassoio tondo bar

Round bar tray

Plateau rond bar

Platte - rund

Bandeja redonda bar

	ø Cm	ø In
V01 05 23 T46	46 Cm	18,1/8



### Tagliere tondo

Round cutting board

Planche ronde

Schneidebrett - rund

Tabla para cortar redonda

### Polietilene

	Cm	In	Sp. Mm	Th. In
V77 12 71 T46	41	16,1/8	2	0,3/4

**Portaformaggi/affettati rettangolare completo refrigerato con base in acciaio**

Thermal rectangular cheese dish

Plateau fromage-charcuterie rectangulaire réfrigéré

Käse/Wurstwarenplatte - rechteckig

Quesera rectangular refrigerante

	Cm	H Cm	In	H In
V77 05 54 G11 R	53x32,5	19	20,7/8x12,3/4	7,1/2

**Coperchio a bascula rettangolare trasparente**

Transparent rectangular rolltop cover

Cloche basculante rectangulaire transparente

Rolltophaube-rechteckig

Campana rectangular transparente

	Cm	In
V77 12 15 G11	47x27	18,1/2x10,5/8

**Tagliere rettangolare**

Rectangular cutting board

Planche à découper rectangulaire

Rechteckiges Schneidebrett

Tabla de cortar rectangular

**Polietilene**

	Cm	In	Sp. Mm	Th. In
V77 12 71 G11	47x27	18,1/2x10,5/8	1,5	0,5/8

**Bacinella rettangolare**

Rectangular pan

Cuvette rectangulaire

Schüssel - rechteckig

Cubeta rectangular

	Cm	H Cm	In	H In
V77 05 14 G11	53x32,5	3,5	20,7/8x12,3/4	1,1/8

**8 Eutettici rettangolari**

8 Ice packs

8 Blocs réfrigérants

8 Kühlakkus

8 Acumuladores de frío rectangulares

V77 12 95 P00

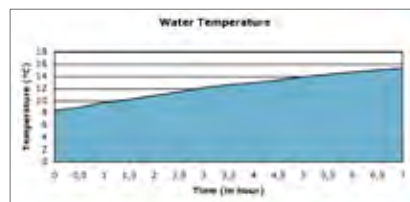

Temperatura ambiente  
External temperature 19,6°

Temperatura acqua  
Water temperature 18,9°

Mezzo refrigerante  
Cooler system 8 eutettici ghiaccio piccoli  
8 small ice pack

## Portaformaggi/affettati tondo completo refrigerato con base in acciaio

Thermal round cheese dish

Plateau fromage-charcuterie rond réfrigéré

Käse/Wurstwarenplatte - rund

Quesera redonda refrigerante

	Cm	H Cm	In	H In
V77 05 54 T46 R	46	27,5	18,1/8	10,7/8



### Coperchio a bascula tondo trasparente

Transparent round rolltop cover

Cloche basculante ronde transparente

Rolltophaube - rund

Campana redonda transparente

	∅ Cm	∅ In
V77 12 15 T46	41	16,1/8



### Tagliere tondo

Round cutting board

Planche ronde

Schneidebrett - rund

Tabla para cortar redonda

### Polietilene

	Cm	In	Sp. Mm	Th. In
V77 12 71 T46	41	16,1/8	2	0,3/4



### Bacinella tonda

Round pan

Cuvette ronde

Schüssel - rund

Cubeta redonda

	∅ Cm	H Cm	∅ In	H In
V77 05 14 T46	46	5	18,1/8	2



### 4 Eutettici rettangolari

4 Ice packs

4 Blocs réfrigérants

4 Kühlakkus

4 Acumuladores de frío rectangular

V77 12 95 G00

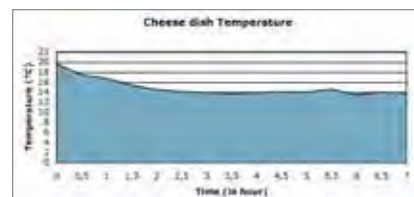

Temperatura ambiente  
External temperature

20,9°

Temperatura acqua  
Water temperature

19,5°

Mezzo refrigerante  
Cooler system

4 eutettici ghiaccio piccoli  
4 small ice pack

# BUFFET IMPERIAL

## Scaldavivande rettangolare con coperchio rotante

Rectangular rolltop chafing dish

Chafing dish rectangulaire avec couvercle pivotant

Chafing Dish - rechteckig mit Rolltophaube

Calientaplatos rectangular con campana

	GN	Cm	H Cm	In	H In
V77 05 52 CHR	1/1	65,5x48	44	25,3/4x19	17,3/8

### Con:

Coperchio rotante a scomparsa

Portavivande 1/1 Gastronorm

2 bruciatori per pasta - combustibile

Predisposto per piastra elettrica

### With:

Rolltop

1/1 gastronorm food pan

2 solid fuel burners.

Electric heating element

(available as optional)



### Fornelletto per scaldavivande

Chafing-dish burner

Porte-brûleur pour chafing dish

Brennstoffhalter für Chafing Dish

Contenedor de combustible para chafing dish

V77 05 52 FDC



### Piastra elettrica per scaldavivande

Heating element for chafing-dishes

Plaque électrique réchauffeur chafing dish

Elektro - Heizelement für Chafing Dish

Plancha eléctrica para calienta platos

	V	W	Hz
V77 05 52 PCR	220	500	50

V77 05 52 PCR1 230 250

Con regolatore With power regulator

### Con fornelli

Whit burners

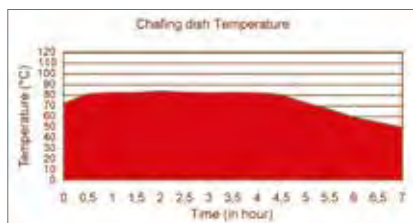

Temperatura ambiente External temperature 20,3°

Temperatura acqua Water temperature 94°

Quantità acqua inserita Quantity of water added 6 Lt.

Fonte di calore Heat source 2 fornelli a fiamma 2 burners

### Con piastra elettrica

Whit heating element

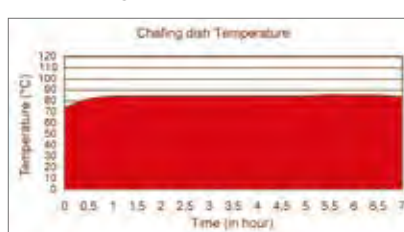

Temperatura ambiente External temperature 20,3°

Temperatura acqua Water temperature 94°

Quantità acqua inserita Quantity of water added 6 Lt.

Fonte di calore Heat source piastra elettrica heating element

## Scaldavivande tondo con coperchio rotante

Round rolltop chafing dish

Chafing dish rond avec couvercle pivotant

Chafing Dish - rund mit Rolltophaube

Calientaplatos redondo con campana

	∅ Cm	H Cm	∅ In	H In
V77 05 52 CHT	50	46	15,3/4	18,1/8

### Con:

Coperchio rotante a scomparsa

Portavivande ∅ 40 Cm

1 bruciatore per pasta - combustibile

Predisposto per piastra elettrica

### With:

Rolltop

Food pan ∅ 40 Cm

Solid fuel burners.

Electric heating element

(available as optional)



### Fornelletto per scaldavivande

Chafing-dish burner

Porte-bruleur pour chafing dish

Brennstoffhalter für Chafing Dish

Contenedor de combustible para chafing dish

V77 05 52 FDC



### Piastra elettrica per scaldavivande

Heating element for chafing-dishes

Plaque électrique réchauffeur chafing dish

Elektro - Heizelement für Chafing Dish

Plancha eléctrica para calienta platos

	V	W	Hz
V77 05 52 PCT	220	500	50

V77 05 52 PCT1 230 250

Con regolatore With power regulator

### Con fornelli

Whit burners

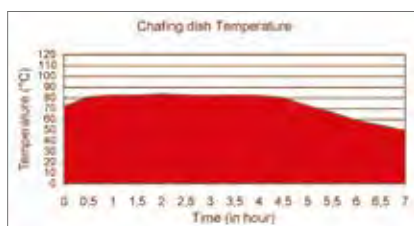

Temperatura ambiente External temperature	20,3°
Temperatura acqua Water temperature	94°
Quantità acqua inserita Quantity of water added	6 Lt.
Fonte di calore Heat source	2 fornelli a fiamma 2 burners

### Con piastra elettrica

Whit heating element

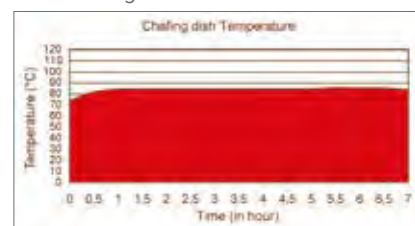

Temperatura ambiente External temperature	20,3°
Temperatura acqua Water temperature	94°
Quantità acqua inserita Quantity of water added	6 Lt.
Fonte di calore Heat source	piastra elettrica heating element

**Portavivande in porcellana**

Food pan, porcelain  
Bac en porcelaine  
Porzellanbehälter  
Cubeta de porcelana

	GN	Cm	In
V01 21 52 G11B	1/1	53x32,5x6,5	20,7/8x12,3/4x2,1/2
V01 21 52 G23B	2/3	35,3x32,5x6,5	13,3/4x12,3/4x2,1/2
V01 21 52 G12B	1/2	26,5x32,5x6,5	10,3/8x12,3/4x2,1/2
V01 21 52 G13B	1/3	17,6x32,5x6,5	6,7/8x12,3/4x2,1/2

**Portavivande tondo in porcellana**

Round food pan, porcelain  
Bac rond en porcelaine  
Porzellanbehälter, rund  
Cubeta redonda de porcelana

	ø Cm	ø In
V01 21 52 T40	40	15,3/4

**Inserto scaldavivande tondo in porcellana**

Food pan half round chafing dish, porcelain with divider  
Bac double en porcelaine pour chafing dish rond  
Porzellaninsatz, 2tlg für Chafing Dish  
Cubeta avec separation de porcelana para chafing dish redondo

	ø Cm	ø In
V01 21 71 T12 (1 pz.)	40 Cm	15,3/4

**Set zuppiere per scaldavivande tondo**

Soup tureen set for Cm. 40 round chafing dish  
Set de soupières pour chafing dish rond  
Suppenschüssel für Chafing Dish rund  
Set de soperas para chafing dish redondo

	ø Cm	ø In	Lt	Oz
V77 05 52 ACT	40	15,3/4	4,2	142

**Set minstre per scaldavivande rettangolare**

Soup tureen set for rectangular chafing dish  
Set de soupières pour chafing dish rectangulaire  
Suppenschüssel für Chafing Dish rechteckig  
Set de soperas para chafing dish rectangular

	GN	Lt	Oz
V77 05 52 ACR	1/1	4,2	142



## Porta cereali girevole a 3 comparti\*

Triple rotating cereal holder  
 Distributeur céréales pivotant à 3 compartiments  
 Büffet-Ständer - drehbar mit 3 Glasschalen  
 Dipensador de cereales giratorio 3 sectores

	ø Cm	ø In
V77 05 52 CER 3	42	16,1/2



\*Sono escluse le ciotole in vetro  
 \*Without glass bowls

## Porta cereali girevole a 6 comparti\*

6-dish rotating cereal holder  
 Distributeur céréales pivotant à 6 compartiments  
 Büffet-Ständer - drehbar mit 6 Glasschalen  
 Dipensador de cereales giratorio 6 sectores

	ø Cm	ø In
V77 05 52 CER	42	16,1/2 in



## Ciotola in vetro

Glass bowl  
 Bol en verre  
 Glasschale  
 Bol de vidrio

	ø Cm	ø In	Lt	Oz
310 08 42 527	23	9	1,3	60



## Coperchio in metacrilato

Acrylic lid  
 Couvercle acrylique  
 Deckel aus Metakryl  
 Tapa acrílica

	ø Cm	ø In
310 12 15 795	23	9

Con pomolo in metacrilato - With acrylic knob

	ø Cm	ø In
310 12 15 790	23	9

Con pomolo in acciaio Inox - With St. Steel knob



**Distributore cereali girevole a 3 comparti con base in acciaio**

Triple rotating cereal dispenser with stainless steel base

Distributeur céréales pivotant à 3 compartiments avec base en acier Inoxidable

3-Müslidispenser-drehbar mit Stahlboden

Dispensador de cereales giratorio 3 sectores con base de acero Inoxidable

	ø Cm	H Cm	ø In	H In	Lt	Oz
V77 05 52 CD6	42	60	16,1/2	23,5/8	3 (x3)	101 (x3)

**Con:**

Contentore removibile

Pomolo in metallo

Spazzola interna

Girandola dosatrice

**With:**

Removable container

Metal knob

Inner brush

Doser handle

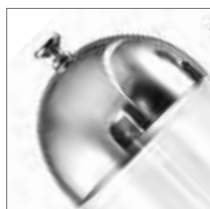
**Contentore removibile**

Consente di riempirlo e pulirlo facilmente

**Removable container**

It allows to be filled in and cleaned easily

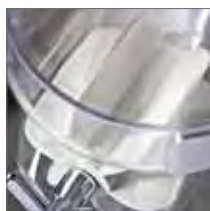
**Spazzola interna**

non rompe i cereali

**Inner brush**

that does not break cereals

**Dettaglio pomolo in metallo**

Detail of metal knob

**Girandola dosatrice**

Doser handle





**Distributore cereali singolo con base in acciaio**

Single cereal dispenser with stainless steel base

Distributeur céréales individuel avec base en acier Inoxidable

Müslidispenser mit Stahlboden

Dispensador de cereales individual con base de acero Inoxidable

	Cm	H Cm	In	H In	Lt	Oz
V77 05 52 CD4	31x21	60	12,1/4x8,1/4	23,5/8	3	101



**Distributore cereali a 2 comparti con base in acciaio**

Double cereal dispenser with stainless steel base

Distributeur céréales à 2 compartiments avec base en acier Inoxidable

2-Müslidispenser mit Stahlboden

Dispensador de cereales 2 sectores con base de acero Inoxidable

	Cm	H Cm	In	H In	Lt	Oz
V77 05 52 CD5	37,5x24,5	60	14,3/4x9,5/8	23,5/8	3 (x2)	101 (x2)



## Portayogurt

Yogurt tray  
Plateau porte-yogourt  
Joghurtplatte  
Bandeja yogur

	ø Cm	ø In	H Cm	H In
V77 05 52 T46	46	18,1/8	5	2



## Portaburro/crostacei

Butter tray  
Plateau porte-beurre/crustacés  
Butter/Krustazeenplatte  
Bandeja mantequilla

	ø Cm	ø In	H Cm	H In
V77 05 09 T32	32	12,5/8	5	2
V77 05 09 T46	46	18,1/8	5	2



## Tagliere per pane con base acciaio

Bread cutting board  
Planche à découper à pain  
Tabla de cortar pan  
Brotschneidebrett

	Cm	H Cm	In	H In
V01 05 54 004	53x32,5	3,5	20,7/8x12,3/4	1,1/8



### Cestino portabrioche tondo con cloche basculante

Round croissant basket with rolltop cover

Corbeille ronde à viennoiseries avec cloche basculante

Büffetkorb - rund mit Rolltophaube

Cesta de buffet redonda con campana roll top

#### Rattan

	ø Cm	ø In	HCm	H In
V77 04 52 T44	44	17,3/8	35	13,3/4



#### Coperchio a bascula tondo trasparente

Transparent round rolltop cover

Cloche basculante ronde transparente

Rolltophaube - rund

Campana redonda roll top transparente

	ø Cm	ø In
V77 12 15 T46	41	16,1/8



#### Cestino rattan

Rattan basket

Corbeille rottin

Rattankorb

Cesta ratán

	ø Cm	ø In
V77 04 24 T44	41	17,3/8

#### Interno rotondo in adatto al contatto con gli alimenti

Inside base for rattan round croissant basket. Suitable for food contact

Revêtements intérieurs, apte au contacte alimentaire

Innenverkleidung Lebensmittel geeignet

Forro interior, apto para alimentos

#### Polistirene

	ø Cm	ø In	H Cm	H In
Z77 46 52 T44	41	14,1/8	11	4,3/8

## Cestino portabrioches rettangolare con cloche basculante

Rattan rectangular croissant basket with rolltop cover  
 Corbeille rectangulaire à viennoiseries avec cloche basculante  
 Büffetkorb - rechteckig mit Rolltophaube  
 Cesta de buffet rectangular con campana roll top

### Rattan

	Cm	In	H Cm	H In
V77 04 52 R50	50x29,5	19,3/4x11,5/8	29,5	11,5/8



### Coperchio a bascula rettangolare trasparente

Transparent rectangular rolltop cover  
 Cloche basculante rectangulaire transparente  
 Rolltophaube - rechteckig  
 Campana roll top rectangular transparente

	Cm	In
V77 12 15 G36	37x21	14,1/2x8,1/4
V77 12 15 G11	47x27	18,1/2x10,5/8



### Cestino rattan

Rattan basket  
 Corbeille rottin  
 Rattankorb  
 Cesta ratán

	Cm	In
V77 04 24 R39	38,5x23	15,1/8x9
V77 04 24 R50	50x29,5	19,3/4x11,5/8

### Interno rettangolare adatto al contatto con gli alimenti

Inside base for rattan rectangular croissant basket. Suitable for food contact  
 Revêtements intérieurs, apte au contacte alimentaire  
 Innenverkleidung Lebensmittel geeignet  
 Forro interior para cestas de buffet, apto para alimentos

### Polistirene

	∅ Cm	∅ In	H Cm	H In
Z77 46 52 R50	50x27	15x7,5/8	11	4,3/8

**Coperchio in metacrilato**

Acrylic lid  
Couvercle acrylique  
Deckel Acryl  
Tapa acrílica

	∅ Cm	∅ In
<b>310 12 15 795</b>	<b>23</b>	<b>9</b>

**Con pomolo in metacrilato - With acrylic knob**

<b>310 12 15 790</b>	<b>23</b>	<b>9</b>
----------------------	-----------	----------

**Con pomolo in acciaio Inox - With St. Steel knob**

**Ciotola in vetro**

Glass bowl  
Bol en verre  
Glasschale  
Bol de vidrio

	∅ Cm	∅ In	HCm	H In
<b>310 08 42 527</b>	<b>23</b>	<b>9</b>	<b>10,5</b>	<b>4,1/8</b>



**Rinfrescamacedonia/yogurt  
con contenitore ghiaccio esterno con coperchio**

Fruit-salad/yogurt cooler with outer ice container and lid

Rafraîchisseur salade de fruits/yogourt avec récipient à glace externe et couvercle

Joghurt/Obstsalatbehälter mit Eisbehälter außen und mit Deckel

Portaensalada de frutas/yogur refrigerado con recipiente para hielo externo y tapa

**Metacrilato**

	∅ Int. Cm	∅ Int. In	∅ est. Cm	∅ est. In
V77 05 43 YOG 2	23	9	26	10,1/4



**Rinfrescamacedonia/yogurt  
con contenitore ghiaccio esterno in acciaio con coperchio**

Fruit-salad/yogurt cooler with outer ice container and lid

Rafraîchisseur salade de fruits/yogourt avec récipient à glace externe avec couvercle

Joghurt/Obstsalatbehälter mit Edelstahl - Eisbehälter außen mit Deckel

Portaensalada de frutas/yogur refrigerado con recipiente para hielo externo con tapa

**Acciaio**

	∅ Int. Cm	∅ Int. In	∅ est. Cm	∅ est. In
V77 05 43 YOG	23	9	28	11



**Distributore caffè con rubinetto in metallo**

Coffee urn

Distributeur café

Kaffeedispenser

Dispensador de café

	Ø Cm	Ø In	H Cm	H In	Lt	Oz
V77 05 52 DCA	21	8,4	54	21,1/4	7	237
V77 05 52 DCA 1	21	8,4	62	24,3/8	10	350

**Rubinetto in metallo**

Metal tap

Robinet en métal

Metallhahn

Grifo de metal

Z77 18 52 OTT

**Piastra elettrica per distributore caffè**

Heating element for coffee urns

Plaque électrique pour distributeur de café

Elektro-Heizelement für Kaffeedispenser

Plancha eléctrica para dispensadores de café

	Ø Cm	Ø In
V77 05 52 PDC	14	5,1/2

**Fornelletto per scaldavivande/distributore caffè**

Burner for chafing dishes-coffee urns

Porte bruleur pour chafing dish et distributeur café

Brennstoffhalter für Chafing Dish und Kaffeedispenser

Contenedor de combustible para chafing dish - dispensadores de café

V77 05 52 FDC

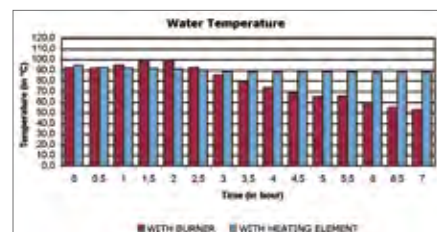
Temperatura ambiente  
External temperature

20,0°

Temperatura acqua  
Water temperature

92,5°/98,8°

Quantità acqua inserita  
Quantity of water added

8 Lt



## Distributore succhi

Juice dispenser  
Distributeur jus  
Saftdispenser  
Dispensador de zumo



### Con rubinetto in metallo

With metal tap  
Avec robinet en métal  
Mit Metallhahn  
Con grifo de metal

	Cm	H Cm	Lt
<b>V77 05 52 DSM</b>	<b>25x35</b>	<b>66</b>	<b>8</b>
	In	H In	Oz
	<b>9,7/8x13,3/4</b>	<b>26</b>	<b>270</b>

### Rubinetto in metallo

Metal tap  
Robinet en métal  
Metal- Holzständer  
Grifo de metal

**Z77 18 52 OTT**



### Con rubinetto in plastica

With plastic tap  
Avec robinet en plastique  
Mit Kunststoffhahn  
Con grifo de plástico

	Cm	H Cm	Lt
<b>V77 05 52 DSU</b>	<b>25x35</b>	<b>66</b>	<b>8</b>
	In	H In	Oz
	<b>9,7/8x13,3/4</b>	<b>26</b>	<b>270</b>

### Rubinetto in plastica nero

Black plastic tap  
Robinet en plastique noir  
Plastikhahn, Schwarz  
Grifo de plástico negro

**Z77 18 52 POL**



### Contentitore trasparente

Transparent container  
Récipient transparent  
Durchsichtbare Behälter  
Contenedor transparente

	Lt	Oz
<b>Z77 63 52 000</b>	<b>8</b>	<b>270</b>



### Eutettici tondi

Round ice packs  
Blocs réfrigérants  
Kühlakkus  
Acumuladores de frío rectangulares

**V77 12 95 T01**



### Supporto refrigerato per caraffe succhi con vassoio portabicchieri\*

Thermal stand for juice pitchers with glasses tray\*

Support réfrigéré pour carafes jus avec plateau porte-verres

Saftkaraffenständer gekühlt mit Gläserständer

Soporte refrigerante para jarras zumo con bandeja para vasos

	ø Cm	ø In	H Cm	H In
<b>V77 05 52 SUC</b>			<b>67</b>	<b>26,3/8</b>
Base	41,5	16,3/8		
Alzata - Holder	38,5	15,1/8		
Sede caraffa - Pitcher seat	16,4	6,1/2		

### Supporto refrigerato per caraffe succhi\*

Thermal stand for juice\* pitchers

Support réfrigéré pour carafes jus

Saftkaraffenständer gekühlt

Soporte refrigerante para jarras zumo

	ø Cm	ø In	H Cm	H In
<b>V77 05 52 SUS</b>			<b>36</b>	<b>14,1/8</b>
Base	41,5	16,3/8		
Sede caraffa - Pitcher seat	16,4	6,1/2		



### Disco coprietettici per supporto refrigerante per caraffe

Plate for thermal stand for juice pitchers (to cover ice packs)

Plaque couvre-blocs réfrigérants pour support réfrigéré pour carafes

Deckel für Kühlelemente zum Karaffenbehälter

Placa cubre acumuladores de frío para soporte refrigerante para jarras

	ø Cm	ø In
<b>PRV 1A SU CAD S0</b>	<b>41</b>	<b>16,1/8</b>

\*Sono escluse le caraffe in vetro

\*Without pitchers

## Caraffa succhi

Juice pitcher  
Carafe jus  
Saftkanne  
Jarra zumo

	Lt	Oz
<b>V76 08 52 005</b>	<b>1,5</b>	<b>51</b>

Con coperchio in metallo - with metal lid 18/10

<b>V76 08 52 009</b>	<b>1,5</b>	<b>51</b>
----------------------	------------	-----------

Senza coperchio - without lid



## Coperchio in acciaio 18/10

Stainless steel lid  
Couvercle en acier 18/10  
Deckel aus Edelstahl  
Tapa de acero Inoxidable

**Z76 01 52 005**



## Caraffa termica 18/10

Thermal beverage serve  
Carafe thermos avec anse  
Thermische Karaffe  
Jarra térmica

	Cl	Oz
<b>V01 05 08 T06</b>	<b>75</b>	<b>26</b>
<b>V01 05 08 T10</b>	<b>100</b>	<b>35</b>
<b>V01 05 08 T15</b>	<b>150</b>	<b>51</b>
<b>V01 05 08 T20</b>	<b>200</b>	<b>68</b>



### 75 Cl - 26 Oz

**Temperatura ambiente** 19,6°  
External temperature

**Temperatura acqua** 94°  
Water temperature

**Quantità acqua inserita** 60 cl.  
Quantity of water added

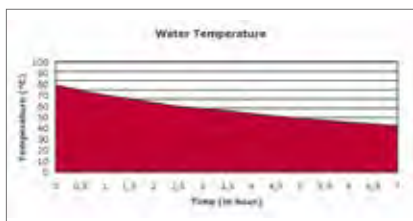

### 100 Cl - 35 Oz

**Temperatura ambiente** 19,6°  
External temperature

**Temperatura acqua** 94°  
Water temperature

**Quantità acqua inserita** 90 cl.  
Quantity of water added

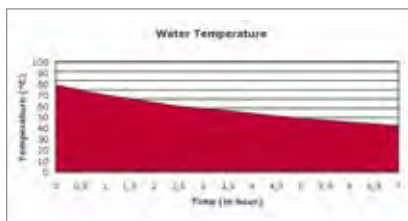

### 150/200 Cl - 53/70 Oz

**Temperatura ambiente** 20,9°  
External temperature

**Temperatura acqua** 95°  
Water temperature

**Quantità acqua inserita** 150 cl.  
Quantity of water added

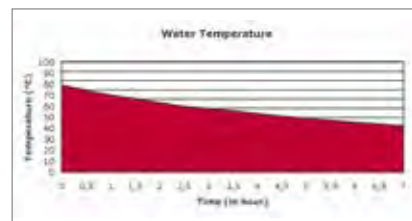

**Alzata torta**

Cake stand  
Presentoir à gâteau  
Tortenplatte  
Soporte tarta

**Inox 18/10 - St. Steel**

	ø Cm	ø In	H Cm	H In
V01 05 42 022	22	8,5/8	9,5	3,3/4
V01 05 42 032	32	12,5/8	12,5	12,5
V01 05 42 042	42	16,1/2	16,5	6,1/2

**Alzata torta 3 piani**

3-tier cake stand  
Présentoir à gâteau 3 étages  
Kuchenständer 3-stufig  
Soporte tarta con 3 pisos

**Inox 18/10 - St. Steel**

	ø Cm	ø In	H Cm	H In
V01 05 42 301	22/32/42	8,5/8-12,5/8-16,1/2	43,5	17,1/8

**Alzata frutta 3 piani**

3- tier fruit stand  
Serviteur à fruits 3 étages  
Obstständer 3-stufig  
Frutero con 3 pisos

**Inox 18/10 - St. Steel**

	ø Cm	ø In	H Cm	H In
V77 05 42 326	22/29/36,5	8,5/4-11,3/8-14,3/8	44	17,3/8



## Piatto torta con coperchio a bascula

Cake tray with roll top cover  
 Plateau à gâteaux avec cloche basculante  
 Kuchenplatte mit Rolltophaube  
 Plato para tartas con campana roll top

### Inox 18/10 - St. Steel

	∅ Cm	∅ In
V76 05 42 003	38	15

## Coperchio a bascula tondo trasparente

Transparent round rolltop cover  
 Cloche basculante ronde transparente  
 Rolltophaube - rund  
 Campana redonda transparente

### SAN

	∅ Cm	∅ In
V76 12 15 T01	34	13,3/8



## Alzata torta con coperchio a bascula

Cake stand with roll top cover  
 Présentoir à gâteaux avec cloche basculante  
 Kuchenplatte mit Schaukeldeckel  
 Soporte para tartas con campana roll top

### Inox 18/10 - St. Steel

	∅ Cm	H Cm	∅ In	H In
V76 05 42 002	38	12,5+32	15	4,7/8 + 12,5/8



## Vassoio torta con cupola in policarbonato Basic

Basic cake tray with acrylic dome cover  
 Plateau à gâteau avec cloche acrylique Basic  
 Kuckenplatte mit Akrylglocke Basic  
 Plato para tartas con campana acrílica Basic

### Inox 18/10 - St. Steel

	∅ Cm	∅ In
V01 05 42 T32	31	12,1/4







TAVOLA • TABLE

**Caffettiera Imperial**

Imperial coffeepot  
Cafetière Imperial  
Kaffekanne Imperial  
Cafetera Imperial

**Inox 18/10 - St. Steel**

	Cl	Oz
V01 05 01 035	35	12
V01 05 01 060	60	20
V01 05 01 100	100	35
V01 05 01 150	150	51
V01 05 01 200	200	68

**Teiera Imperial**

Imperial teapot  
Théière Imperial  
Teekanne Imperial  
Tetera Imperial

**Inox 18/10 - St. Steel**

	Cl	Oz
V01 05 02 035	35	12
V01 05 02 060	60	20
V01 05 02 100	100	35
V01 05 02 130	130	44

**Lattiera Imperial**

Imperial milkpot  
Pot à lait Imperial  
Milchkanne Imperial  
Lechera Imperial

**Inox 18/10 - St. Steel**

	Cl	Oz
V01 05 03 035	35	12
V01 05 03 060	60	20
V01 05 03 100	100	35

**Cremiera Imperial**

Imperial creamer  
Crémier Imperial  
Sahnekännchen Imperial  
Jarrita de leche Imperial

**Inox 18/10 - St. Steel**

	Cl	Oz
V01 05 03 015	15	5





**Caraffa termica Imperial**

Imperial thermal beverage server  
Carafe thermos Imperial  
Thermoskanne Imperial  
Jarra térmica Imperial

**Inox 18/10 - St. Steel**

	Cl	Oz
V01 05 08 T06	70	24
V01 05 08 T10	100	35
V01 05 08 T15	150	51
V01 05 08 T20	200	68

**Zuccheriera con maniglie Imperial**

Imperial sugar pot with lid and handles  
Sucrier avec couvercle et poignées Imperial  
Zuckerdose mit Griffen und Deckel Imperial  
Azucarero con tapa y asas Imperial

**Inox 18/10 - St. Steel**

	Gr	Oz
V01 05 04 280	280	10

**Brocca acqua Imperial**

Imperial water pitcher  
Carafe à eau Imperial  
Wasserkrug Imperial  
Jarra agua Imperial

**Inox 18/10 - St. Steel**

	Cl	Oz
V01 05 08 150	150	51
V01 05 08 200	200	68

**Zuccheriera Imperial**

Imperial sugar pot  
Sucrier Imperial  
Zuckerdose Imperial  
Azucarero Imperial

**Inox 18/10 - St. Steel**

	Gr	Oz
V01 05 04 200	200	7



**Portacannucce**

Straw holder  
 Porte-pailles  
 Trinkhalmbehälter  
 Portapajitas

**Inox 18/10 - St. Steel**

	∅ Cm	∅ In	H Cm	H In
V01 05 71 011	9	3,1/2	11	4,3/8

**Portacucchiaini**

Tea spoon holder  
 Porte-cuillères à café  
 Kaffeelöffelbecher  
 Portacucharas café

**Inox 18/10 - St. Steel**

	∅ Cm	∅ In	H Cm	H In
V01 05 71 008	9	3,1/2	8	3,1/8

**Portabustine zucchero/the**

Rectangular sugar tray  
 Sucrier rectangulaire  
 Zucker-Behälter  
 Azucarero rectangular

**Inox 18/10 - St. Steel**

	Cm	In	H Cm	H In
V78 05 04 PBU	10x6,5	4	3,5	1,3/8

**Passatè (colino tè) con coppetta**

Tea strainer  
 Passoire à the  
 Teesieb  
 Colador de te

**Inox 18/10 - St. Steel**

	Cm	H Cm	In	H In
V01 05 91 001	9,5x5	3	3,3/4x2	1,1/8



**Portauovo**

Egg cup  
Coquetier  
Eierbecher  
Huevera

**Inox inossidabile - St. Steel**

	∅ Cm	∅ In
V01 05 71 001	8,6	3,3/8

**Burriera piccola con coperchio**

Small butter dish with cover  
Petit beurrier avec cloche  
Klein Butterschale mit Deckel  
Mantequera pequeña con tapa

**Inox 18/10 - St. Steel**

	∅ Cm	∅ In	
V01 05 09 107	7	2,3/4	
Z01 20 09 107	7	2,3/4	porcellana/porcelain

**Burriera con coperchio**

Butter dish with cover  
Beurrier avec cloche  
Butterschale mit Deckel  
Mantequera con tapa

**Inox 18/10 - St. Steel**

	∅ Cm	∅ In	
V01 05 09 115	15	6	
Z01 20 09 115	15	6	porcellana/porcelain

**Portasalatini 3 scomparti**

3-tier snack/relish dish  
Porte-biscuits salés à 3 compartiments  
Salzgebäckschale, 3-tlg  
Entremesera 3 sectores

**Inox 18/10 - St. Steel**

	∅ Cm	∅ In
V01 05 41 003	10,5	4,1/8



**Portamarmellata per 4 confezioni**

4-jar jam holder

Porte-confiture pour 4 pots

Konfitürenschaale, 4 tlg

Dispensador de mermelada para 4 botes

**Inox 18/10 - St. Steel**

	Cm	In
V76 05 09 001	18x45	7,1/8x1,3/4

**Portamarmellata 3 scomparti**

3-tier jam dish

Porte-confiture à 3 compartiments

Konfitürenschaale, 3 tlg

Dispensador de mermelada 3 sectores

**Inox 18/10 - St. Steel**

	∅ Cm	H Cm	∅ In	H In
V01 05 09 003	6	13	2,3/8	5,1/8

**Portamarmellata 6 scomparti**

6-tier jam dish

Porte-confiture à 6 compartiments

Konfitürenschaale, 6 tlg

Dispensador de mermelada 6 sectores

**Inox 18/10 - St. Steel**

	∅ Cm	H Cm	∅ In	H In
V01 05 09 006	6	17,5	2,3/8	6,7



**Alzata pasticceria**

Petit four stand  
Support à pâtisserie  
Petits-Fours-Ständer  
Presentación pastelería

**Inox 18/10 - St. Steel**

	ø Cm	H Cm	ø In	H In
V01 05 41 012	12	11	4,3/4	4,3/8
V01 05 41 016	16	11,5	6,1/4	4,1/2
V01 05 41 022	22	12	8,5/8	4,3/4

**Alzata pasticceria 2 piani**

2-tier petit four stand  
Support à pâtisserie à 2 étages  
Petits-fours ständer 2-stufig  
Presentación pastelería 2 pisos

**Inox 18/10 - St. Steel**

	ø Cm	H Cm	ø In	H In
V01 05 41 201	12/16	21,5	4,3/4-6,1/4	8,1/2
V01 05 41 202	16/22	22,5	6,1/4-8,5/8	8,7/8

**Alzata pasticceria 3 piani**

3-tier petit four stand  
Support à pâtisserie à 3 étages  
Kuchenständer 3-stufig  
Presentación pastelería 3 pisos

**Inox 18/10 - St. Steel**

	ø Cm	H Cm	ø In	H In
V01 05 41 301	12/16/22	31	4,3/4-6,1/4-8,5/8	12,1/4



**Servitore té/pasticceria**

Afternoon tea stand  
Stand thé/pâtisserie  
Tee/Kuchenstander  
Soporte para platos

**Inox 18/10 - St. Steel**

	∅ Cm	H Cm	∅ In	H In
V76 05 42 005	30	42	11,3/4	16,1/2
V76 05 42 004	25	40	9,7/8	15,3/4

**Alzata torta**

Cake stand  
Surtout  
Kuchenteller  
Bandeja para tarta

**Inox 18/10 - St. Steel**

	∅ Cm	H Cm	∅ In	H In
CI 22600	32	3,5	12,5/8	1,3/8

**Alzata torta**

Cake stand  
Presentoir à gâteau  
Tortenplatte  
Presentación tarta

**Inox 18/10 - St. Steel**

	∅ Cm	H Cm	∅ In	H In
V01 05 42 022	22	9,5	8,5/8	3,3/4
V01 05 42 032	32	12,5	12,5/8	12,5
V01 05 42 042	42	16,5	16,1/2	6,1/2

**Alzata torta 3 piani**

3-tier cake stand  
Présentoir à gâteau 3 étages  
Kuchenständer 3-stufig  
Presentación tarta 3 pisos

**Inox 18/10 - St. Steel**

	∅ Cm	H Cm	∅ In	H In
V01 05 42 301	22/32/42	43,5	8,5/8-12,5/8-16,1/2	17,1/8



**Alzata frutta**

Fruit stand  
 Serviteur à fruits  
 Obststände  
 Frutero

**Inox 18/10 - St. Steel**

	ø Cm	H Cm	ø In	H In
V77 05 42 126	22	12,5	8,5/8	5
V77 05 42 132	29	12,5	11,3/8	5
V77 05 42 138	36,5	12,5	14,3/8	5

**Alzata frutta 2 piani**

2-tier fruit stand  
 Serviteur fruits à 2 étages  
 Obststände 2-stufig  
 Frutero 2 pisos

**Inox 18/10 - St. Steel**

	ø Cm	H Cm	ø In	H In
V77 05 42 226	22/29	22,5	8,5/8-11,3	8-8,7/8

**Alzata frutta 3 piani**

3- tier fruit stand  
 Serviteur à fruits 3 étages  
 Obststände 3-stufig  
 Frutero 3 pisos

**Inox 18/10 - St. Steel**

	ø Cm	H Cm	ø In	H In
V77 05 42 326	22/29/36,5/44	8,5/4	11,3/8/14,3/8	17,3/8



**Sottopiatto bordo inglese**

Show plate with English decoration

Plat à présentation avec décoration anglaise

Platzteller mit englischer Dekoration

Plato de presentación con borde inglés

**Inox 18/10 - St. Steel**

	∅ Cm	∅ In
V01 05 25 132	31,5	12,3/8

**Sottopiatto liscio**

Show plate, plain

Plat à présentation simple

Platzteller

Plato de presentación liso

**Inox 18/10 - St. Steel**

	∅ Cm	∅ In
V01 05 25 032	31	12,1/4

**Sottobottiglia**

Bottle coaster

Sous bouteille

Flaschenuntersatz

Posabotella

**Inox 18/10 - St. Steel**

	∅ Cm	∅ In
V01 05 21 014	14	5,1/2

**Sottobicchiere**

Glass coaster

Sous verre

Untersatz

Posavasos

**Inox 18/10 - St. Steel**

	∅ Cm	∅ In
V01 05 21 011	11	4,3/8





**Cestino pane rettangolare Square**

Bread basket Square, rectangular  
 Corbeille à pain rectangulaire Square  
 Brotkorb Square, rechteckig  
 Cesta pan rectangular Square

**Inox 18/10 - St. Steel**

	Cm	In
V76 05 24 002	20x12	7,7/8x4,3/4

**Cestino pane rettangolare Square**

Bread basket Square, rectangular  
 Corbeille à pain rectangulaire Square  
 Brotkorb Square, rechteckig  
 Cesta pan rectangular Square

**Inox 18/10 - St. Steel**

	Cm	In
V76 05 24 003	27x12	10,5/8x4,3/4

**Panno per cestino pane c/velcro ecru**

Cloth for bread basket, beige  
 Tissu pour corbeille à pain écru  
 Sandfarbenes Tuch für Brotkorb  
 Paño para cesta pan beige

	Cm	In
AS9 1CP	27	10,5/8

**Cestino in filo agrumi**

Citrus-fruit basket

Corbeille à agrumes

Obstkorb Edelstahl Draht für Zitrusfrüchte

Cesta cítricos

**Inox 18/10 - St. Steel**

	∅ Cm	H Cm	∅ In	H In
906 05 001	21 Cm	20	8,1/4	7,7/8

**Cestino frutta tondo in filo**

Fruit basket, round, wire

Corbeille a fruits ronde en fil d'acier

Drahtobstkorb, rund

Cesta frutas redonda en hilo

**Inox 18/10 - St. Steel**

	∅ Cm	H Cm	∅ In	H In
906 05 004	25	9	9,7/8	3,1/2

**Cestino frutta tondo in filo**

Fruit basket, round, wire

Corbeille a fruits ronde en fil d'acier

Drahtobstkorb, rund

Cesta frutas redonda en hilo

**Inox 18/10 - St. Steel**

	∅ Cm	H Cm	∅ In	H In
906 05 003	20	8	7,7/8	3,1/8

**Cestino frutta tondo in filo**

Fruit basket, round, wire

Corbeille a fruits ronde en fil d'acier

Drahtobstkorb, rund

Cesta frutas redonda en hilo

**Inox 18/10 - St. Steel**

	∅ Cm	H Cm	∅ In	H In
906 05 002	18	7	7,1/8	2,3/4



**Cestino in filo grissini**

Bread stick basket  
Corbeille à gressins  
Grissini-Korb Edelstahl Draht  
Cesta palillos

**Inox 18/10 - St. Steel**

	∅ Cm	H Cm	∅ In	H In
906 05 005	10	14	3,7/8	5,1/2

**Cestino ovale in filo**

Oval s/s basket  
Corbeille ovale  
Ovalkorb Edelstahl Draht  
Cesta oval

**Inox 18/10 - St. Steel**

	Cm	H Cm	In	H In
906 05 016	28x21	9	11x8,1/4	3,1/2

**Cestino ovale in filo**

Oval s/s basket  
Corbeille ovale  
Ovalkorb Edelstahl Draht  
Cesta oval

**Inox 18/10 - St. Steel**

	Cm	H Cm	In	H In
906 05 015	25x18	8	9,7/8x7	3,1/8

**Cestino ovale in filo**

Oval s/s basket  
Corbeille ovale  
Ovalkorb Edelstahl Draht  
Cesta oval

**Inox 18/10 - St. Steel**

	Cm	H Cm	In	H In
906 05 014	20x15	7	7,7/8x6	2,3/4



**Coppetta liscia multiuso**

Small cup, plain multipurpose  
 Petite coupe simple multi-usage  
 Universalschale  
 Copita lisa multiuso

**Inox 18/10 - St. Steel**

	Cm	In
V05 05 43 L13	13	5,1/8

**Cestino pane liscio Majorca**

Mallorca bread basket, plain  
 Corbeille à pain Mallorca  
 Brotkorb Mallorca  
 Cesta pan Mallorca lisa

**Inox 18/10 - St. Steel**

	Cm	In
V05 05 24 L18	18,5x18,5	7,1/4 x7,1/4
V05 05 24 L23	23x23	9x9

**Cestino pane forato Majorca**

Mallorca bread basket, slotted  
 Corbeille à pain Mallorca, perforée  
 Lochbrotkorb Mallorca  
 Cesta pan con agujeros Mallorca

**Inox 18/10 - St. Steel**

	Cm	In
V05 05 24 F18	18,5x18,5	7,1/4 x7,1/4
V05 05 24 F23	23x23	9x9

**Cestino pane ovale**

Bread basket, oval  
 Corbeille à pain ovale  
 Brotkorb, oval  
 Cesta pan oval

**Inox 18/10 - St. Steel**

	Cm	In
V01 05 24 028	28x15	11x6



**Anello adattatore**

Adjusting ring  
Bague de réglage  
Einsatzring  
Anillo adaptador

**Inox 18/10 - St. Steel**

	Cm	In
V01 05 43 540	13 Cm	5,1/8

**Coppetta interna**

Supreme inside cup  
Coupe intérieure  
Schale  
Copita interior

**Inox 18/10 - St. Steel**

	Cm	In
V01 05 43 562	10,5	4,1/8

**Piattino portaburro**

Butter dish  
Plat à beurre  
Butterschale  
Platito mantequilla

**Inox 18/10 - St. Steel**

	ø Cm	ø In
V01 05 43 648	13	5,1/8

**Griglia portaburro**

Butter grid  
Grille porte-beurre  
Buttergitter  
Parrilla mantequilla

**Inox 18/10 - St. Steel**

	ø Cm	ø In
V01 05 43 539	13	5,1/8

**Coppa esterna base**

Supreme outside base cup  
Coupe base extérieure Supreme  
Schale auf Fuß  
Copa exterior base Supreme

**Inox 18/10 - St. Steel**

	ø Cm	ø In
V01 05 43 130	13	5,1/8

**Coppa Supreme completa**

Supreme cup  
Coupe Supreme  
Hummer-/Cocktailschale  
Copa Supreme, completa

**Inox 18/10 - St. Steel**

	ø Cm	H Cm	ø In	H In
V01 05 43 C13	13	8,5	5,1/8	3,3/8
3 Pezzi - 3 Pieces				

V01 05 43 C135	13	8,5 Cm	5,1/8	3,3/8
5 Pezzi - 5 Pieces				

**Set breakfast**

Breakfast set  
Service petit déjeuner  
Tablet mit Frühstückzubehören  
Set desayuno

**Inox 18/10 - St. Steel**

	Cm	In
V76 05 23 002	24	9,1/2

**Set lunch**

Lunch set  
Service lunch  
Öl und Essig set Tablett  
Set almuerzo

**Inox 18/10 - St. Steel**

	Cm	In
V76 05 23 003	24	9,1/2

**Set sauces appetizer**

Set sauces appetizer  
Service sauces-appetizer  
Söße und Apertiven set Soßen  
Set salsas-aperitivos

**Inox 18/10 - St. Steel**

	Cm	In
V76 05 23 004	24	9,1/2



**Vetro salino Square c/tappo**

Glass cruet salt spreader Square w/cap  
 Verre pour salière Square avec couvercle  
 Salzstreuer mit Schraubverschluß  
 Vidrio salero Square c/tapa

**Acciaio inossidabile - St. Steel**

V76 05 12 001

**Ampolla olio/aceto Square c/tappo**

Glass cruet oil/vinegar set Square w/cap  
 Burette huile/vinaigre Square avec bouchon  
 Essig/Ölglasflasche mit Schraubverschluß  
 Alcuza aceite/vinagre Square c/tapa

**Acciaio inossidabile - St. Steel**

V76 05 11 001

**Portatovaglioli Square**

Napkin holder  
 Porte-serviettes  
 Serviettenhalter  
 Servilletero

**Inox 18/10 - St. Steel**

	Cm	H Cm	In	H In
V76 05 71 001	11x4	8	4,3/8x1,2/3	3,1/8

**Portabustine zucchero/tè**

Packed sugar/tea holder  
 Conteneur sachets de sucre/té  
 Zucker-Teebeutelbehälter  
 Porta sobres de azúcar/té

**Inox 18/10 - St. Steel**

	Cm	H Cm	In	H In
V78 05 04 PBU	10x6,5	3,5	3,7/8x2,1/2	1,3/8

**Ciotola porcellana quadra**

Porcelain square bowl  
 Bol carré en porcelaine  
 Porzellanschale, viereckig  
 Bol cuadrado de porcelana

**Porcelain**

	Cm	In
V86 21 42 CQ7	7x7	2,3/4x2,3/4

**Vaso Formaggiera con coperchio**

Cheese bowl  
 Ravier a parmesan  
 Käsedose  
 Quesera

**Acciaio inossidabile - St. Steel**

V76 05 13 002



**Coppa macedonia Imperial**

Fruit salad cup  
Coupe à dessert  
Obstsalatschale  
Copa macedonia

**Inox 18/10 - St. Steel**

	∅ Cm	∅ In	H Cm	H In
V01 05 43 125	12,5	5	5,5	2

**Coppa gelato**

Ice cream cup  
Coupe à glace  
Eisschale  
Copa helado

**Inox 18/10 - St. Steel**

	∅ Cm	∅ In
V01 05 43 105	10,5	4,1/8

**Coppa gelato Imperial**

Imperial ice cream cup  
Coupe à glace Imperial  
Eisschale Imperial  
Copa helado Imperial

**Inox 18/10 - St. Steel**

	∅ Cm	∅ In	H Cm	H In
V01 05 43 010	9,5	3,3/4	10	4

**Piattino sottocoppa**

Cup saucer  
Plat sous coupe  
Untersatz  
Platito posacopa

**Inox 18/10 - St. Steel**

	∅ Cm	∅ In
V01 05 21 013	13	5,1/8

**Portafiori**

Flower vase  
Vase à fleurs  
Blumenvase  
Florero

**Inox 18/10 - St. Steel**

	H Cm	H In
V01 05 19 015	16,5	6,1/2





**Vassoio rendiresto bordo inglese**

Small change tray with English edge  
 Plateau porte-monnaie avec rebord anglais  
 Geldplatte mit englischem Rand  
 Bandeja portamoneda con borde inglés

**Inox 18/10 - St. Steel**

	Cm	In
V01 05 23 R25	24x9,5	9,1/2x3,3/4

**Vassoio multiuso**

Multipurpose tray  
 Plateau universelle  
 Universale Platte  
 Bandeja universal

**Inox 18/10 - St. Steel**

	Cm	In
CI 3005	24x9,5	9,1/2x3,3/4
CI 3006	29x13,5	11,1/2x5,3/8

**Salsiera con piattino**

Sauce boat with underliner  
 Saucière avec soucoupe  
 Soßenschüssel mit Tellerchen  
 Salsera con platito

**Inox 18/10 - St. Steel**

	Cl	Mm
V61 05 12 030	30	0,8

**Salsiera**

Sauce boat  
 Saucière  
 Soßenschüssel  
 Salsera

**Inox 18/10 - St. Steel**

	Cl	Mm
CI 25401	10	0,8
CI 25402	20	0,8
CI 25403	30	0,8

**Cloche**

Dome cover  
 Cloche  
 Speiseglocke  
 Campana

**Inox 18/10 - St. Steel**

	Ø Cm	Ø In
V01 05 53 024	24	9,1/2
V01 05 53 026	26	10,1/4
V01 05 53 028	28	11
V01 05 53 030	30	11,3/4



**Portatovaglioli**

Napkin holder  
Porte-serviette  
Serviettenhalter  
Servilletero

**Inox 18/10 - St. Steel**

	Cm	H Cm	In	H In
V01 05 71 105	10,5	9	4,1/8	3,1/2

**Portatovaglioli**

Napkin holder  
Porte-serviettes  
Serviettenhalter  
Servilletero

**Inox 18/10 - St. Steel**

	Cm	H Cm	In	H In
V76 05 71 001	11x4	8	4,3/8x1,2/3	3,1/8

**Portatovaglioli quadrato**

Napkin holder, square  
Porte-serviette carré  
Viereckiger Serviettenhalter  
Servilletero cuadrado

**Inox 18/10 - St. Steel**

	Cm	H Cm	In	H In
V01 05 71 190	19x19	7	7,1/2x7,1/2	2,3/4

**Portakleenex**

Kleenex holder  
Porte-kleenex  
Taschentücherhalter  
Porta kleenex

**Inox 18/10 - St. Steel**

	Cm	H Cm	In	H In
V01 05 71 002	22x12	5,5	8,5/8x4,3/4	2,1/8

**Lavadita**

Finger bowl  
Rince-doigts  
Fingerschale  
Lavadedos

**Inox 18/10 - St. Steel**

	∅ Cm	∅ In
V01 05 43 012	12	4,3/4



**Portatovaglioli da banco verticale**

Vertical napkin holder

Porte-serviettes vertical

Vertikaler Thekenserviettenhalter

Servilletero cuadrado vertical

**Inox 18/10 - St. Steel**

	Cm	H Cm	In	H In
906 05 008	8,5x11	16	3,3/8x4,3/8	6,1/4

**Legatovaglioli tondo**

Round napkin ring

Rond de serviette

Serviettenhalter

Servilletero redondo

**Inox 18/10 - St. Steel**

	∅ Cm	∅ In
V01 05 81 001	4 Cm	1,2/3

**Paletta raccoglibriciole**

Crumb sweeper

Pelle ramasse-miettes

Krümelsammler

Pala recogemigas

**Inox 18/10 - St. Steel**

	Cm	In
903 05 91 939	12	4,3/4

**Legatovaglioli ovale**

Oval napkin ring

Rond de serviettes ovale

Serviettenhalter, oval

Servilletero oval

**Inox 18/10 - St. Steel**

	Cm	In
V01 05 81 000	5x4	2x1,2/3



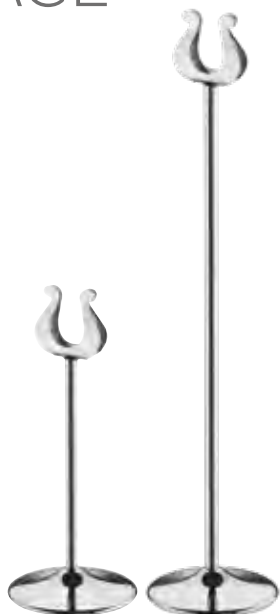

### Segnatavolo a colonna (portanumero)

Table number stand, column-shaped

Support numéro de table à colonne

Tischnummerständer

Número sobremesa a columna

#### Inox 18/10 - St. Steel

	H Cm	H In
V01 05 19 019	19	7,1/2
V01 05 19 046	45	17,3/4



### Cavalletto portaetichetta per buffet

Buffet easel for tags

Chevalet porte-nom pour buffet

Aufsteller Produktinfo

Soporte caballete para etiqueta para buffet

#### Inox 18/10 - St. Steel

	H Cm	H In
V01 05 19 001	14,5	5,3/4

### Tavoletta nera per cavalletto

Black tag for easel

Plaque pour chevalet noir

Schild für Produktinfo

Etiqueta negra para soporte caballete

#### Plexiglass

	H Cm	H In
V01 12 19 001	10x7,5	4x3



### Portatoast in filo

Toast holder, steel wire

Porte-toasts en fil

Toastständer

Portatostadas en hilo

#### Inox 18/10 - St. Steel

	Cm	H Cm	In	H In
V01 05 71 195	19,5	15	7,5/8	6

**Formaggiara Imperial**

Imperial grated-cheese holder  
 Ravier à parmesan Imperial  
 Käsedose Imperial  
 Quesera Imperial

**Inox 18/10 - St. Steel**

V01 05 13 001



**Oliera 4 pezzi Imperial**

Imperial oil & vinagar cruet set, 4-piece  
 Ménagère Imperial, 4 pièces  
 Menage, 4-tlg Imperial  
 Servicio de mesa Imperial, 4 piezas

**Inox 18/10 - St. Steel**

V01 05 11 005



**Oliera 2 pezzi Imperial**

Imperial oil & vinagar cruet set, 2-piece  
 Ménagère Imperial, 2 pièces  
 Menage, 2-tlg Imperial  
 Servicio de mesa Imperial, 2 piezas

**Inox 18/10 - St. Steel**

V01 05 11 002



**Tris sale, pepe e stecchi Imperial**

Imperial salt and pepper shakers and toothpick holder  
 Salière, poivrière et porte cure-dents Imperial  
 Salz/Pfefferstreuer und Zahnstocherträger Imperial, 3-tlg  
 Salero, pimentero y palillero Imperial

**Inox 18/10 - St. Steel**

V01 05 12 003



**Spargi sale/pepe singolo Imperial**

Imperial salt/pepper shaker  
 Salière/poivrière individuelle Imperial  
 Salz/Pfefferstreuer Imperial  
 Salero/pimentero individual Imperial

**Inox 18/10 - St. Steel**

V01 05 12 001



**Formaggiara 2000**

2000 Cheese bowl  
Fromagère 2000  
Käsedose 2000  
Quesera 2000

**Acciaio inossidabile - St. Steel**

---

V61 05 13 001

**Oliera 5 pezzi Menage**

Menage oil & vinegar cruet set, 5-piece  
Ménagère Menage, 5 pièces  
Menage, 5-tlg  
Servicio de mesa Menage, 5 piezas

**Acciaio inossidabile - St. Steel**

---

V12 06 11 005

**Tris sale, pepe e stecchi Inox**

Salt and pepper shakers and toothpick holder, plain  
Salière, poivrière et porte cure-dents simples  
Salz/Pfefferstreuer mit Zahnstochträger, Edelstahl  
Tris salero, pimentero y palillero Inox

**Acciaio inossidabile - St. Steel**

---

V12 06 12 003



## Oliera 2 pezzi Victory

Victory oil & vinegar cruet set, 2-piece  
 Ménagère Victory, 2 pièces  
 Essig/Ölgestell 2-tlg Victory  
 Servicio de mesa Victory, 2 piezas

**Inox 18/10 - St. Steel**

V52 05 11 002



## Tris sale, pepe e stecchi Victory

Victory salt and pepper shakers and toothpick holder  
 Salière, poivrière et porte cure-dents Victory  
 Salz/Pfeffersteuer mit Zahnstocherträger, 3-tlg Victory  
 Salero, pimentero y palillero Victory

**Inox 18/10 - St. Steel**

V52 05 12 003



## Formaggiera Victory

Victory grated-cheese holder  
 Ravier à parmesan Victory  
 Käsedose Victory  
 Quesera Victory

**Inox 18/10 - St. Steel**

V52 05 13 001



## Oliera 5 pezzi Victory

Victory oil & vinegar cruet set, 5-piece  
 Ménagère Victory, 5 pièces  
 Essig/Ölgestell 5-tlg Victory  
 Servicio de mesa Victory, 5 piezas

**Inox 18/10 - St. Steel**

V52 05 11 005



**Sale/pepe Square**

Glass cruet salt spreader Square

Verre pour salière Square

Salzstreuer mit

Vidrio salero Square

**Acciaio inossidabile - St. Steel**

	Cm	In	H Cm	H In
V76 05 12 002	9,5x4,5	3,3/4x1,3/4	12,5	5

**Oliera 2 pz olio/aceto Square**

Glass cruet oil/vinegar set Square

Burette huile/vinaigre Square

Essig/Ölglas flaschen mit

Alcuza aceite/vinagre Square

**Acciaio inossidabile - St. Steel**

	Cm	In	H Cm	H In
V76 05 11 002	12,5x5,5	5x2,1/8	20	7,7/8

**Formaggiera Square**

Cheese bowl Square

Ravier a parmesan Square

Käsedose Square

Quesera Square

**Acciaio inossidabile - St. Steel**

	Cm	In	H Cm	H In
V76 05 13 001	8,5x9	3,3/8x3,1/2	8,5	3,3/8







**Portabottiglie olio/aceto con spargisale/pepe**

Oil and vinegar bottle rack with salt and pepper shakers  
 Porte bouteilles huile-vinaigre, salière, poivrière  
 Essig/Ölflaschenträger, Salz/Pfeffersteuer  
 Portabotellas aceite y vinagre, salero, pimentero

**Acciaio inossidabile - St. Steel**

	Cl	Oz	Cm
AVARI 060 A	25	9	12x5,5x25
AVARI 061 A	50	17,5	14x7x81



**Portabottiglie olio/aceto**

Oil and vinegar bottle rack  
 Porte bouteilles huile-vinaigre  
 Essig/Ölflaschenträger  
 Portabotellas aceite y vinagre

**Acciaio inossidabile - St. Steel**

	Cl	Oz	Cm
AVARI 060	25	9	12x6,5x25
AVARI 061	50	17,5	14,5x7,5x32

**Oliera Pasha**

Pasha oil & vinegar cruet set  
Ménagère Pasha  
Menage Pasha  
Servicio de mesa Pasha

- V02 12 11 004 07
- V02 12 11 004 12
- V02 12 11 004 13
- V02 12 11 004 34
- V02 12 11 004 47

**Oliera Jolly**

Jolly oil & vinegar cruet set  
Ménagère Jolly  
Menage Jolly  
Servicio de mesa Jolly

- V10 12 11 004 41
- V10 12 11 004 34
- V10 12 11 004 43
- V10 12 11 004 38
- V10 12 11 004 40
- V10 12 11 004 47

**Formaggiera Pasha con vaso vetro**

Pasha grated-cheese holder  
Ravier à parmesan Pasha  
Käsedose Pasha  
Quesera Pasha

**PP+PS**

- V02 12 13 001 07
- V02 12 13 001 12
- V02 12 13 001 13
- V02 12 13 001 34
- V02 12 13 001 47

**Formaggiera Jolly**

Jolly grated-cheese holder  
Ravier à parmesan Jolly  
Käsedose Jolly  
Quesera Jolly

**PP+PS**

- V10 12 13 001 41
- V10 12 13 001 34
- V10 12 13 001 43
- V10 12 13 001 38
- V10 12 13 001 40
- V10 12 13 001 47



## Ricambi Imperial/Victory

Imperial/Victory spare parts  
Pièces de rechange Imperial/Victory  
Imperial/Victory Ersatzteilen  
Repuestos Imperial/Victory

**AR33** TAPPO OLIERA CON SALVAGOCCIA / DROP STOP CAP OIL CRUETS

**AR31** CAPSULA SALINO / CAP SALT SHAKER

**AR32** CAPSULA STECCHI / CAP TOOTHPICK HOLDERS



AR31

AR32

## Ricambi Cronos

Cronos spare parts  
Pièces de rechange Cronos  
Cronos Ersatzteilen  
Repuestos Cronos

**AR8** TAPPO OLIERA CON SALVAGOCCIA / DROP STOP CAP OIL CRUETS

**AR12** CAPSULA SALE E PEPE / CAP FOR SALT AND PEPPER

**AR25** CAPSULA STECCHI / CAP FOR TOOTHPICK

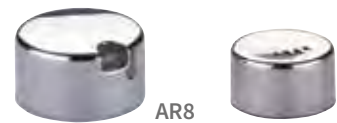

AR8

AR12



AR25

## Ampolla vetro oliera Cronos/Imperial/Victory

Glass cruet for Cronos/Imperial/Victory cruet sets  
Bouchon anti-goutte pour huilier Imperial/Victory  
Glas Ersatzteil für Öl-und Essigset  
Tapón antigoteo para aceitera Imperial/Victory

	∅ Cm	H Cm	∅ In	H In
<b>AR3</b>	<b>5</b>	<b>13,5</b>	<b>2</b>	<b>5,3/8</b>



## Vetro formaggiera Cronos/Imperial/Pasha/Jolly

Glass bowl for Cronos/Imperial/Pasha/Jolly  
Bol en verre pour ravier à parmesan Cronos/Imperial/Pasha/Jolly  
Glas Ersatzteil für Käsedose Cronos/Imperial/Pasha/Jolly  
Bol de vidrio para Cronos/Imperial/Pasha/Jolly

	∅ Cm	H Cm	∅ In	H In
<b>AR14</b>	<b>9</b>	<b>4,9</b>	<b>3,1/2</b>	<b>2</b>



## Vetro salino Mondial/Cronos/Imperial/Pasha/Jolly/Menage/Dribbly

Glass bowl for Mondial/Cronos/Imperial/Pasha/Jolly/Menage/Dribbly salt/pepper shakers  
Bouteille verre pour salière Mondial/Cronos/Imperial/Pasha/Jolly/Menage/Dribbly  
Glas Ersatzteil für Salz und Pfefferstreuer  
Botellita de vidrio para salino Mondial/Cronos/Imperial/Pasha/Jolly/Menage/Dribbly shakers

	∅ Cm	H Cm	∅ In	H In
<b>AR4</b>	<b>3-5</b>	<b>8</b>	<b>1,3/8</b>	<b>3,1/8</b>



**Vassoio tondo bar**

Round bar tray  
Plateau rond bar  
Austellplatte, rund  
Bandeja redonda bar

**Inox 18/10 - St. Steel**

	∅ Cm	∅ In
V01 05 23 T32	32	12,5/8
V01 05 23 T38	38	15
V01 05 23 T46	46	18,1/8
V01 05 23 T54	54	21,1/4

**Vassoio tondo bar con maniglie**

Round bar tray with handles  
Plateau rond bar avec poignées  
Austellplatte mit Griffen, rund  
Bandeja redonda bar con asas

**Inox 18/10 - St. Steel**

	∅ Cm	∅ In
V01 05 23 T32M	32	12,5/8
V01 05 23 T38M	38	15
V01 05 23 T46M	46	18,1/8
V01 05 23 T54M	54	21,1/4

**Vassoio tondo con bordo Basic**

Round tray Basic  
Plateau rond Basic  
Austellplatte, rund Basic  
Bandeja redonda Basic

**Inox 18/10 - St. Steel**

	∅ Cm est.	∅ Cm Int.	∅ In ext.	∅ In Int.
V01 05 23 TB31	31	27	12,1/4	10,5/8
V01 05 23 TB36	36	30	14,1/8	11,3/4
V01 05 23 TB41	41	35	16,1/8	13,3/4

**Vassoio birra**

Beer tray  
Plateau à bière  
Bierplatte  
Bandeja para cerveza

**Inox 18/10 - St. Steel**

	∅ Cm	∅ In
CI 5411	30	11,3/4
CI 5412	40	15,3/4



**Vassoio rettangolare gastronorm**

Gastronorm tray, rectangular  
 Plateau rectangulaire Gastronorm  
 Austellplatte, rechteckig, Gastronorm  
 Bandeja rectangular Gastronorm

**Inox 18/10 - St. Steel**

	Cm	In
V01 05 23 G12	26,5x32,5	10,3/8x12,3/4
V01 05 23 G11	53x32,5	20,7/8x12,3/4
V01 05 23 G21	65x53	25,5/8x20,7/8

**Vassoio rettangolare gastronorm con maniglie**

Gastronorm tray with handles, rectangular  
 Plateau rectangulaire Gastronorm avec poignées  
 Austellplatte mit Griffen, rechteckig, Gastronorm  
 Bandeja rectangular Gastronorm con asas

**Inox 18/10 - St. Steel**

	Cm	In
V01 05 23 G12M	32,5x26,5	12,3/4x10,3/8
V01 05 23 G11M	53x32,5	20,7/8x12,3/4
V01 05 23 G21M	65x53	25,5/8x20,7/8

**Vassoio rettangolare Basic**

Gastronorm tray, rectangular  
 Plateau rectangulaire Gastronorm  
 Austellplatte, rechteckig, Gastronorm  
 Bandeja rectangular Gastronorm

**Inox 18/10 - St. Steel**

	Cm	In
V01 05 23 GB12	26,5x32,5	10,3/8x12,3/4
V01 05 23 GB11	53x32,5	20,7/8x12,3/4
V01 05 23 GB21	65x53	25,5/8x20,7/8

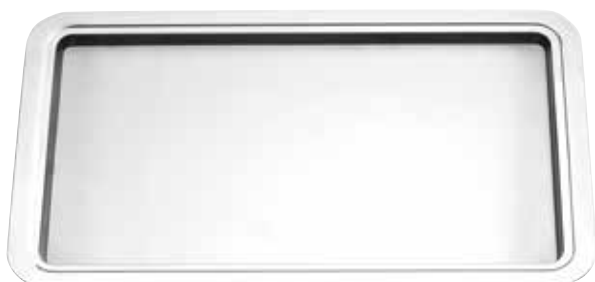
**Vassoio gratin ovale**

Gratin tray  
 Plat gratin ovale  
 Ovale Gratinplatte  
 Plato gratin oval

**Inox 18/10 - St. Steel**

	Cm	In
CI 24501	28x17	11x6,3/4



**Vassoio rettangolare bar con bordo**

Bar tray with edge, rectangular  
 Plateau rectangulaire bar avec rebord  
 Austellplatte, rechteckig  
 Bandeja rectangular bar con borde

**Inox 18/10 - St. Steel**

	Cm	In	Sp. mm
V01 05 23 R30	30x24	11,3/4x9,1/2	0,8
V01 05 23 R35	35x29	13,3/4x11,1/2	0,8
V01 05 23 R40	40x31	15,3/4x12,1/4	1,0
V01 05 23 R45	45x34	17,3/4x13,3/8	1,0
V01 05 23 R52	52x40	20,1/2x15,3/4	1,0
V01 05 23 R62	62x48	24,3/8x19	1,0

**Vassoio rettangolare bar senza bordo**

Bar tray without edge, rectangular  
 Plateau rectangulaire bar sans rebord  
 Austellplatte rechteckig  
 Bandeja rectangular bar sin borde

**Inox 18/10 - St. Steel**

	Cm	In	Sp. mm
V03 05 23 R27	27x21	10,5/8x8,1/4	0,8
V03 05 23 R30	30x24	11,3/4x9,1/2	0,8
V03 05 23 R35	35x28	13,3/4x11	0,8
V03 05 23 R40	40x32	15,3/4x12,5/8	1,0
V03 05 23 R45	45x35	17,3/4x13,3/4	1,0
V03 05 23 R50	50x38	19,3/4x15	1,0

**Vassoio rettangolare bar Easy con bordo**

Easy bar tray with edge, rectangular  
 Plateau rectangulaire bar Easy avec rebord  
 Rechteckig Ausstellplatte "Easy" mit Rand  
 Bandeja rectangular bar Easy con borde

**Inox 18/CR - St. Steel**

	Cm	In	Sp. mm
V65 05 23 R32	32x26	12,5/8x10,1/4	0,6
V65 05 23 R36	36x29	14,1/8x11,1/2	0,6
V65 05 23 R40	40x33	15,3/4x13	0,6
V65 05 23 R45	45x34	17,3/4x13,3/8	0,6

**Vassoio rettangolare bar senza bordo**

Bar tray without edge, rectangular  
 Plateau rectangulaire bar sans rebord  
 Austellplatte rechteckig  
 Bandeja rectangular bar sin borde

**Inox 18/CR - St. Steel**

	Cm	In	Sp. mm
V03 06 23 R27	27x21	10,5/8x8,1/4	0,8
V03 06 23 R31	30x24	11,3/4x9,1/2	0,8
V03 06 23 R36	35x28	13,3/4x11	0,8
V03 06 23 R40	40x32	15,3/4x12,5/8	1,0
V03 06 23 R45	45x35	17,3/4x13,3/4	1,0
V03 06 23 R50	50x38	19,3/4x15	1,0



**Piatto portata ovale con bordo Easy**

Easy plate with edge, oval  
Assiette ovale Easy avec rebord  
Oval Tablett "Easy" mit Rand  
Fuente oval Easy con borde

**Inox 18/CR - St. Steel**

	Cm	In
V65 05 23 020	20X11	7,7/8x4,3/8
V65 05 23 025	25x17	9,7/8x6,3/4
V65 05 23 030	30x21	11,3/4x8,1/4
V65 05 23 035	35x24	13,3/4x9,1/2
V65 05 23 040	40x27	15,3/4x10,5/8
V65 05 23 045	45x30	17,3/4x11,3/4
V65 05 23 050	50x33	19,3/4x13
V65 05 23 059	59X40	23,1/4x15,3/4

**Piatto ovale senza bordo**

Plate without edge, oval  
Assiette ovale sans rebord  
Bratenplatte, oval  
Fuente oval sin borde

**Inox 18/10 - St. Steel**

	Cm	In
V03 05 22 025	25x17	9,7/8x6,3/4
V03 05 22 030	30x21	11,3/4x8,1/4
V03 05 22 035	35x24	13,3/4x9,1/2
V03 05 22 040	40x27	15,3/4x10,5/8
V03 05 22 045	45x31	17,3/4x12,1/4
V03 05 22 050	50x35	19,3/4x13,3/4

**Piatto portata tondo con bordo**

Plate with edge, round  
Assiette ronde avec rebord  
Bratenplatte, rund mit Rand  
Fuente redonda con borde

**Inox 18/10 - St. Steel**

	∅ Cm est.	∅ Cm Int.	∅ In ext.	∅ In Int.
V01 05 22 T29	29	20	11,1/2	7,7/8
V01 05 22 T34	34	24	13,3/8	9,1/2
V01 05 22 T38	38	26	15	10,1/4

**Piatto portata pesce**

Fish plate  
Assiette à poisson  
Fischplatte  
Fuente para pescado

**Inox 18/CR - St. Steel**

	Cm	In
V01 05 22 P60	60x24,5	23,5/8x9,5/8
V01 05 22 P70	70x28,5	27,1/2x11,1/4



**Vassoio sovrapponibile gastronomo rettangolare**

Stackable gastronorm rectangular tray

Plateau empilable gastronorme rectangulaire avec poignées

Gastronorm Tablett - rund und stapelbar

Bandeja rectangular gastronorm apilable

**Inox 18/10 - St. Steel**

	Cm	In
V01 05 23 G11S	53x32,5	20,7/8x12,3/4
V01 05 23 G21S	65x53	25,5/8x20,7/8

**Vassoio sovrapponibile gastronomo tondo**

Stackable gastronorm round tray

Plateau empilable rond avec poignées

Tablett-rund und stapelbar

Bandeja redonda gastronorm apilable

**Inox 18/10 - St. Steel**

	∅ Cm	∅ In
V01 05 23 T46S	46	18,1/8
V01 05 23 T54S	54	21,1/4





**Coperchio legumiera/zuppiera**

Cover for vegetable dish/soup tureen

Couvercle pour soupière/légumier

Deckel für Suppen-Gemüseschüssel

Tapa legumbrera/sopera

**Inox 18/10 - St. Steel**

	ø Cm	ø In
V01 05 15 C14	14	5,1/2
V01 05 15 C18	18	7,1/8
V01 05 15 C22	22	8,5/8
V01 05 15 C24	24	9,1/2
V01 05 15 C26	26	10,1/4
V01 05 15 C28	28	11
V01 05 15 C30	30	11,3/4

**Zuppiera**

Soup tureen

Soupière

Suppenschüssel

Sopera

**Inox 18/10 - St. Steel**

	ø Cm	ø In	Lt	Oz
V01 05 15 Z14	14	5,1/2	0,75	25
V01 05 15 Z18	18	7,1/8	1,5	50
V01 05 15 Z22	22	8,5/8	2,5	85
V01 05 15 Z24	24	9,1/2	3,5	118
V01 05 15 Z26	26	10,1/4	4,25	144
V01 05 15 Z28	28	11	5,25	178
V01 05 15 Z30	30	11,3/4	6,5	220

**Legumiera**

Vegetable dish

Légumier

Gemüseschüssel

Legumbrera

**Inox 18/10 - St. Steel**

	ø Cm	ø In	Lt	Oz
V01 05 15 L14	14	5,1/2	0,8	27
V01 05 15 L18	18	7,1/8	1,4	47
V01 05 15 L22	22	8,5/8	1,9	64
V01 05 15 L24	24	9,1/2	2,8	94,6
V01 05 15 L26	26	10,1/4	3,8	128,5
V01 05 15 L28	28	11	4,8	162





**Celsius** è il nuovo piatto che mantiene costante la temperatura delle pietanze senza continuare il processo di cottura, per conservare al meglio il gusto di ogni ricetta.

Design moderno ed essenziale, che si abbina a ogni mise en place e innovativa funzionalità grazie alla presa ergonomica della base in legno, che protegge dalle scottature.

La piastra in alluminio viene **riscaldato in forno**, regolando temperatura e tempo a seconda della pietanza, per poi essere posizionata sotto il piatto in acciaio che, a contatto con gli alimenti, **mantiene costante la temperatura** del cibo durante il pasto.

Celsius è un prodotto **igienico e di facile pulizia**: il piatto in acciaio (unica componente a contatto con gli alimenti) è comodamente lavabile in lavastoviglie, a differenza delle pietre ollari che assorbono i grassi, non sono lavabili e alterano lo stato di cottura delle pietanze.

Celsius è disponibile in quattro versioni per rispondere a ogni esigenza, dal singolo posto tavola ai momenti di convivialità, e in due forme adatte a diverse tipologie di pietanze come ad esempio le carni e la pizza.

**Celsius. Per non servire più cibi freddi!**

**Celsius** is the new plate that keeps food temperature constant without continuing the cooking process, to best preserve the taste of every recipe.

Modern and essential design, matching with every place setting, and innovative functionality, thanks to the ergonomic grip, and the wood base, that protects from burning.

The aluminum plate is **warmed into the oven**, adjusting temperature and time based on the food; then it is placed under the steel plate that, in contact with food, **keeps its temperature constant** during the meal.

Celsius is a healthy product and **easy to clean**: the steel plate (the only component in contact with food) is dishwasher safe while, for instance, soapstone, that absorbs fat, is not washable and alters food cooking.

Celsius comes in four versions to meet every need, from the individual place setting to the large gatherings, and in two different shapes, suitable for different foods, like meat and pizza.

**Celsius. You will not serve cold food anymore!**



# Celsius

**IDEALE PER SERVIRE**  
PERFECT TO SERVE



**CARNE**  
MEAT



**PESCE**  
FISH



**VERDURE**  
VEGETABLES



**PIZZA E NON SOLO**  
PIZZA & MORE



**Vassoio grill rettangolare**

Rectangular grill tray  
 Plateau grill rectangulaire  
 Grilltablett rechteckig  
 Bandeja grill rectangular

	Cm	In
V89 05 22 R01	29x20	11,1/2x7,7/8
V89 05 22 R02	34x24	13,3/8x9,1/2

**Piatto**

Plate  
 Plat  
 Edelstahl Tablett rechteckig  
 Plato

**Acciaio Inox 18/10 - Stainless Steel 18/10**

	Cm	In
Z89 14 22 R01	29x20	9,7/8x7,1/4
Z89 14 22 R02	34x24	11,5/8x8,1/2

**Piastra alluminio**

Aluminum plate  
 Plaque aluminium  
 Aluminiumplatte  
 Placa aluminium

**Alluminio - Aluminum**

	Cm	In
Z89 15 22 R01	19x12	7,1/2x4,3/4
Z89 15 22 R02	24x15,5	9,1/2x6,1/8

**Base rettangolare**

Rectangular base  
 Base rectangulaire  
 Holzgestell rechteckig  
 Base rectangular

**Legno di betulla - Birch wood**

	Cm	In
Z89 19 22 R01	29x20	11,1/2x7,7/8
Z89 19 22 R02	34x24	13,3/8x9,1/2

## Vassoio grill ovale

Oval grill tray  
Plateau grill oval  
Grilltablett oval  
Bandeja grill oval

	Cm	In
V89 05 22 T01	28x32	1x12,5/8
V89 05 22 T02	38x34	15x13,3/8



## Piatto

Plate  
Plat  
Edelstahl Tablett oval  
Plato

### Acciaio Inox 18/10 - Stainless Steel 18/10

	ø Cm	ø In
Z89 14 22 T01	25,5	10
Z89 14 22 T02	31,5	12,3/8



## Piastra alluminio

Aluminum plate  
Plaque aluminium  
Aluminiumplatte  
Placa aluminium

### Alluminio - Aluminum

	ø Cm	ø In
Z89 15 22 T01	20	7,7/8
Z89 15 22 T02	24	9,1/2



## Base ovale

Oval base  
Base ovale  
Holzgestell oval  
Base oval

### Legno di betulla - Birch wood

	Cm	In
Z89 19 22 T01	28x32	1x12,5/8
Z89 19 22 T02	38x34	15x13,3/8





WINE ● BAR

**Glacette doppio corpo**

Double wall bottle cooler  
 Rafrâchisseur à bouteille/vin double paroi  
 Weinkühler, doppelwandig  
 Enfriador de botella doble pared

**Inox 18/10 - St. Steel**

	ø Cm	ø In	H Cm	H In
V78 05 24 014	13	5,1/8	21	8,1/4

**Secchio champagne per 2/3 bottiglie**

Champagne cooler for 2/3 bottles  
 Seau à champagne pour 2/3 bouteilles  
 2/3 Flaschen Champagnekühler  
 Cubo champán para 2/3 botellas

**Inox 18/10 - St. Steel**

	ø Cm	ø In	H Cm	H In
V78 05 20 022	22	8,5/8	21	8,1/4

**Supporto secchio spumante linea Wine&Bar**

Wine&Bar champagne cooler stand  
 Support pour seau à champagne Wine&Bar  
 Wine&Bar Champagnekühler Ständer  
 Soporte para cubo champán Wine&Bar

**Inox 18/10 - St. Steel**

	ø Cm	ø In	H Cm	H In
V78 05 20 675	23	9	58	22,7/8



## Shaker

Cocktail shaker  
Shaker  
Cocktail Shaker  
Coctelera

### Inox 18/10 - St. Steel

	Lt	Oz
V78 05 81 SHA	0,7	17



## Bicchieri Boston

Boston mixing container  
Verre en métal pour Boston  
Boston Metallbecher  
Vaso en metal para Boston

### Inox 18/10 | vetro - St. Steel | glass

	Lt	ø Cm	H Cm	
V78 05 81 SHA 2B 0,7	9	17	6,3/4	acciaio
V78 08 81 SHA 2B 0,7	9	17	6,3/4	vetro



## Secchiello ghiaccio doppio corpo

Double wall ice bucket  
Seau à glace double paroi  
Eiswürfelbehälter, doppelwandig  
Cubo hielo doble pared

### Inox 18/10 - St. Steel

	ø Cm	ø In	H Cm	H In
V78 05 20 014	13	5,1/8	18	7,1/8



## Scoladecanter

Decanter wine stand  
Egouttoir de carafe  
Karaffentrockner  
Soporte para decantador

### Acciaio inossidabile - St. Steel

	H Cm	H In
V01 05 24 020	30	11,3/4

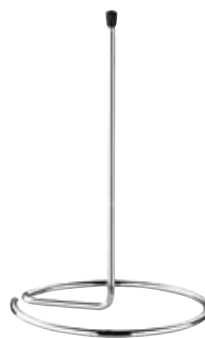

## Versavino

Red wine holder  
Porte-bouteille  
Portabotella  
Rotweinwiege

### Inox 18/10 - St. Steel

	Cm	In
V01 05 24 002	30	11,3/4



**Secchio ghiaccio Modern**

Modern ice bucket  
 Seau à glace Modern  
 Eiswürfelbehälter Modern  
 Cubo hielo Modern

**Inox 18/10 - St. Steel**

		∅ Cm	∅ In	H Cm	H In
V78 05 20 00 11 401	est	15	6	17	6,3/4
	int	13	5,1/8		

**Secchio champagne Modern**

Modern Champagne cooler  
 Seau à champagne Modern  
 Modern Champagnekühler  
 Cubo champán Modern

**Acciaio Inossidabile - St. Steel**

		∅ Cm	∅ In	H Cm	H In
V78 05 20 002		24	9,1/2	22,5	8,7/8

**Glacette**

Modern glacette  
 Glacette Modern  
 Weinkühler Modern  
 Enfriador de botella

**Acciaio Inossidabile - St. Steel**

		∅ Cm	∅ In	H Cm	H In
V78 05 24 01 01 401	est	12	4.3/4	19,5	7,5/8
	int	10	4		

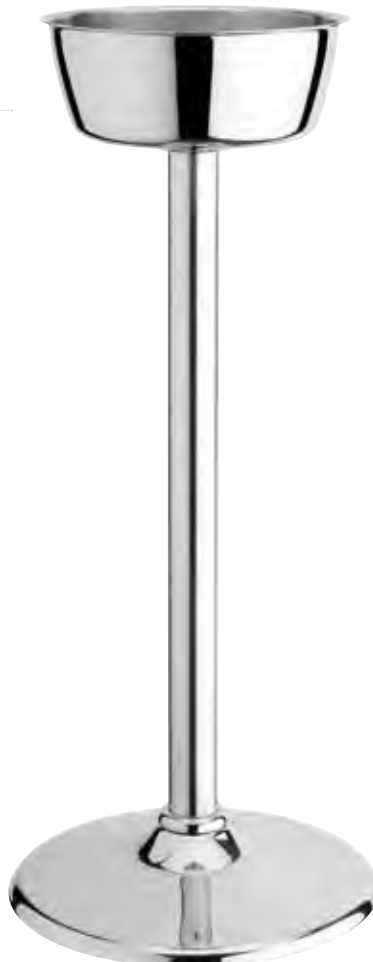
**Supporto secchio Basic**

Basic champagne cooler stand  
 Support pour seau à champagne Basic  
 Basic Champagnekühler Ständer  
 Soporte para cubo champán Basic

**Inox 18/10 - St. Steel**

	H Cm	∅ Cm	H In	∅ In
V01 05 20 674	61	21	24	8,1/4

**Secchio ghiaccio Imperial**

Imperial ice bucket  
 Seau à glace Imperial  
 Imperial Eiswürfelbehälter  
 Cubo hielo Imperial

**Acciaio inossidabile - St. Steel**

	ø Cm	ø In	H Cm	H In
V01 05 20 013	13,5	5,3/8	13	5,1/8

**Secchio champagne Imperial**

Imperial champagne cooler  
 Seau à champagne Imperial  
 Imperial Champagnekühler  
 Cubo champán Imperial

**Acciaio inossidabile - St. Steel**

	ø Cm	ø In	H Cm	H In
V01 05 20 020	21	8,1/4	20	7,7/8

**Supporto secchio Imperial**

Imperial champagne cooler stand  
 Support pour seau à champagne Imperial  
 Imperial Champagnekühler Ständer  
 Soporte para cubo champán Imperial

**Inox 18/10 - St. Steel**

	ø Cm	ø In	H Cm	H In
V01 05 20 675	21	8,1/4	61	24

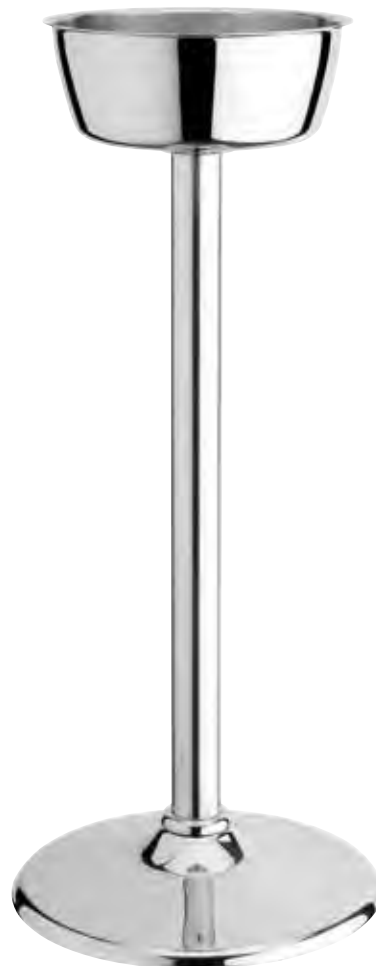

**Secchio champagne Basic**

Basic champagne bucket  
Seau à champagne Basic  
Sektkübler Basic  
Cubo champán Basic

**Acciaio inossidabile - St. Steel**

	ø Cm	ø In	H Cm	H In
906 05 013	21,5	8,1/2	21	8,1/4

**Secchio ghiaccio Basic**

Basic ice bucket  
Seau à glace Basic  
Eiskühler Basic  
Cubo hielo Basic

**Acciaio inossidabile - St. Steel**

	ø Cm	ø In	H Cm	H In
906 05 012	13	5,1/8	13	5,1/8

**Cocktail shaker Basic**

Basic cocktail shaker  
Cocktail shaker Basic  
Cocktail Shaker Basic  
Coctelera Basic

**Acciaio inossidabile - St. Steel**

	Lt	Oz
V78 05 81 SHA11 401	0,5	17

**Misurino Basic**

Basic jigger  
Mésure Basic  
Meßbecher Basic  
Medida bar Basic

**Acciaio inossidabile - St. Steel**

	Ml	Oz
V78 05 81 DOS1	15-30	1/2-1

**Filtro cocktail Basic**

Basic cocktail strainer  
Passoire à cocktail Basic  
Barsieb Basic  
Colador de cóctel Basic

**Acciaio inossidabile - St. Steel**

	Cm	In
V78 05 81 FCO1	14	5,1/2

**Denocciatore**

Olive and cherry pitter  
Dénoyateur à olives Entkerner  
Entkerner  
Deshuesador aceitunas

**Inox 18/10 - St. Steel**

	Cm	In
V78 05 81 DEN	16,2	6,3/8



**Coppa punch**

Punch bowl  
Bol à punch  
Punchschale  
Champañera

**Inox 18/10 - St. Steel**

	ø Cm	ø In	Lt	Oz
V77 05 52 PUN	40	15,3/4	13	439,5

**Coppa champagne con base**

Champagne-bottle holder with base  
Coupe à champagne avec base  
Champagnerschale mit Basis  
Champañera con base

**Inox 18/10 - St. Steel**

	ø Cm	ø In	Lt	Oz
V77 05 52 PUN3	53	20,7/8	25	845

**Coppa punch doppio corpo**

Punch bowl double-wall  
Bol à punch double paroi  
Doppelwandiger Punchschale  
Champañera doble pared

**Inox 18/10 - St. Steel**

	ø Cm	ø In	Lt	Oz
V77 05 52 PUN2	39	15,3/8	10	338

**Coppa champagne**

Champagne bottle holder  
Coupe à champagne  
Champagnerschale  
Champañera

**Inox 18/10 - St. Steel**

	ø Cm	ø In	Lt	Oz
V77 05 52 PUN1	53	20,7/8	25	845



**Cremiera Imperial**

Imperial creampot  
Crémier Imperial  
Imperial Sahnekännchen  
Jarrita de leche Imperial

**Inox 18/10 - St. Steel**

	Cl	Oz
V01 05 03 015	15	5

**Lattiera Imperial**

Imperial milkpot  
Pot à lait Imperial  
Imperial Milchkanne  
Lechera Imperial

**Inox 18/10 - St. Steel**

	Cl	Oz
V01 05 03 035	35	12
V01 05 03 060	60	20
V01 05 03 100	100	35

**Porta cucchiaini**

Spoon holder  
Porte-cuillères  
Löffelbehälter  
Portacucharillas

**Inox 18/10 - St. Steel**

	ø Cm	ø In	H Cm	H In
V01 05 71 008	9	3,1/2	8	3,1/8

**Portacannucce**

Straw holder  
Porte-pailles  
Trinkhalmbehälter  
Porta pajitas

**Inox 18/10 - St. Steel**

	ø Cm	ø In	H Cm	H In
V01 05 71 011	9	3,1/2	11	4,3/8



**Portacucchiaini a 3 posti Europa**

Europa spoon holder, 3-sector  
 Porte cuillères 3 secteurs Europa  
 Kaffeeöffelständer 3 Sektoren Europa  
 Porta cucharitas 3 sectores Europa

**Inox 18/10 - St. Steel**

	Cm	In	H Cm	H In
CI 22202	27x8	10,5/8x3,1/8	8,5-10-12	3,3/8 - 4 - 4,3/4

**Portacucchiaini a 2 posti Europa**

Europa spoon holder, 2-sector  
 Porte cuillères 2 secteurs Europa  
 Kaffeeöffelständer 2 Sektoren Europa  
 Porta cucharitas 2 sectores Europa

**Inox 18/10 - St. Steel**

	Cm	In	H Cm	H In
CI 22201	17x8	6,3/4x3,1/8	8,5 - 10	3,3/8 - 4

**Spargicacao con coperchio in plastica**

Cocoa shaker with plastic cover  
 Saupoudreuse de cacao à couvercle en plastique  
 Kakaostreuer mit Plastikdeckel  
 Espolvoreador con tapa en plástico

**Inox 18/10 - St. Steel**

	Ø Cm	Ø In
909 05 XX 028	5,3	2,1/8

**Portabustine zucchero/tè**

Packed sugar/tea holder  
 Conteneur sachets de sucre/té  
 Zucker und-Teebeutel Behälter  
 Portasobres de azúcar/té

**Inox 18/10 - St. Steel**

	Cm	In	H Cm	H In
V78 05 04 PBU	10x6,5	3,7/8x2,1/2	3,5	1,3/8

**Portatovaglioli Square**

Napkin holder  
 Porte-serviettes  
 Serviettenhalter  
 Servilletero

**Inox 18/10 - St. Steel**

	Cm	In	H Cm	H In
V76 05 71 001	11x4	4,3/8x1,2/3	2	3,1/8

**Portatovaglioli da banco verticale**

Vertical napkin holder  
 Porte-serviettes vertical  
 Vertikaler Thekenserviettenhalter  
 Servilletero cuadrado vertical

**Inox 18/10 - St. Steel**

	Cm	In	H Cm	H In
906 05 008	8,5x11	3,3/8x4,3/8	16	6,1/4



**Portabrioche singolo**

Croissant tray  
 Plateau porte-croissants  
 Brot Büfettkorb  
 Bandeja de buffet

**PP e SAN**

	Cm	In	H Cm	H In
V77 12 52 01P	50x30,5	19,5/8x12,1/8	18,5	7,1/4
V77 12 52 03P	40x24,5	15,3x9,5/8	15,5	6,1/8

**Portabrioche doppio**

Double-deck croissant tray  
 Porte-croissants deux étages  
 Doppelsplatte Brot Büfettkorb  
 Bandeja de buffet con dos pisos

**PP e SAN**

	Cm	In	H Cm	H In
V77 12 52 02P	50x30,5	19,5/8x12,1/8	39	15,3/8

**Portabrioche tondo**

Round croissant tray  
 Porte-croissants rond  
 Brot Büfettkorb rund  
 Bandeja de buffet redonda

**PP e SAN**

	ø Cm	ø In
V77 12 52 0TP	46	18,1/8
V77 12 52 0TP1	38	15





**Portaformaggi/affettati refrigerato singolo**

Thermal food tray rectangular  
 Porte-dîner rectangulaire réfrigérant individuel  
 Wurstwarenplatte, rechteckig  
 Bandeja portaquesos/embutidos rectangular refrigerante individual

**PP e SAN**

	Cm	In	H Cm	H In
V77 12 54 01P	50x30,5	19,5/8x12,1/8	18,5	7,1/4

**Portaformaggi/affettati refrigerato doppio**

Thermal food tray rectangular, double  
 Porte-dîner rectangulaire réfrigérant double  
 Doppelwurstwarenplatte, rechteckig  
 Bandeja portaquesos rectangular refrigerante doble

**PP e SAN**

	Cm	In	H Cm	H In
V77 12 54 02P	50x30,5	19,5/8x12,1/8	39	15,3/8

**Eutettici rettangolari**

Ice packs  
 Blocs réfrigérants  
 Kühlakkus  
 Acumuladores de frío rectangulares

V77 12 95 G00

**Base coprieutettici per portaformaggi refrigerato**

Ice pack cover for termale rectangular cheese dish  
 Base couvre blocs réfrigérants pour porte-dimer réfrigérant  
 Kühlakkus scheinbe für Wurstwaremplate, rechteckig  
 Base para acumuladores de frío para bandeja portaquesos refrigerante

**Inox 18/10 - St. Steel**

	Cm	In
Z77 19 54 01P	43,5x24	17,1/8x9,1/2





## CUCINA • KITCHEN

I contenitori Gastronorm sono studiati e realizzati in conformità alla normativa UNI EN 631-1. Realizzati in AISI 304 (1.4301) per garantire un'ottima resistenza alla corrosione; l'AISI 304 è un acciaio austenitico che può essere utilizzato a contatto con gli alimenti secondo il decreto 11 Novembre 2013 Nr. 140.

*Gastronorm containers are designed and manufactured in compliance with UNI EN 631-1 regulation. Made of AISI 304 (1.4301) to ensure an excellent corrosion resistance; AISI 304 is an austenitic steel that can be used in contact with food according to the Decree of 11 November 2013 No. 140.*



**Contentitore GN 2/1**

GN 2/1 container

Conteneur GN 2/1

GN Behälter Edelstahl Gn 2/1

Contenedor GN 2/1

**Inox 18/10 - St. Steel**

	Cm	H Cm	Sp. Mm
V01 05 72 G21	65x53	2	0,7
V01 05 72 G21A	65x53	4	0,7
V01 05 72 G21B	65x53	6,5	0,7
V01 05 72 G21C	65x53	10	0,7
V01 05 72 G21D	65x53	15	0,7
V01 05 72 G21E	65x53	20	0,7

**Contentitore GN 1/1**

GN 1/1 container

Conteneur GN 1/1

GN Behälter Edelstahl Gn 1/1

Contenedor GN 1/1

**Inox 18/10 - St. Steel**

	Cm	H Cm	Sp. Mm
V01 05 72 G11	53x32,5	2	0,7
V01 05 72 G11A	53x32,5	4	0,7
V01 05 72 G11B	53x32,5	6,5	0,7
V01 05 72 G11C	53x32,5	10	0,7
V01 05 72 G11D	53x32,5	15	0,7
V01 05 72 G11E	53x32,5	20	0,7

**Contentitore GN 2/3**

GN 2/3 container

Conteneur GN 2/3

GN Behälter Edelstahl Gn 2/3

Contenedor GN 2/3

**Inox 18/10 - St. Steel**

	Cm	H Cm	Sp. Mm
V01 05 72 G23	35,4x32,5	2	0,7
V01 05 72 G23A	35,4x32,5	4	0,7
V01 05 72 G23B	35,4x32,5	6,5	0,7
V01 05 72 G23C	35,4x32,5	10	0,7
V01 05 72 G23D	35,4x32,5	15	0,7
V01 05 72 G23E	35,4x32,5	20	0,7



## Contentore GN 1/2

GN 1/2 container  
 Conteneur GN 1/2  
 GN Behälter Edelstahl Gn 1/2  
 Contenedor GN 1/2

### Inox 18/10 - St. Steel

	Cm	H Cm	Sp. Mm
V01 05 72 G12	32,5x26,5	2	0,7
V01 05 72 G12A	32,5x26,5	4	0,7
V01 05 72 G12B	32,5x26,5	6,5	0,7
V01 05 72 G12C	32,5x26,5	10	0,7
V01 05 72 G12D	32,5x26,5	15	0,7
V01 05 72 G12E	32,5x26,5	20	0,7



## Contentore GN 2/4

GN 2/4 container  
 Conteneur GN2/4  
 GN Behälter Edelstahl Gn 2/4  
 Contenedor GN 2/4

### Inox 18/10 - St. Steel

	Cm	H Cm	Sp. Mm
V01 05 72 G24	16,2x53	2	0,7
V01 05 72 G24A	16,2x53	4	0,7
V01 05 72 G24B	16,2x53	6,5	0,7
V01 05 72 G24C	16,2x53	10	0,7
V01 05 72 G24D	16,2x53	15	0,7



## Contentore GN 1/3

GN 1/3 container  
 Conteneur GN 1/3  
 GN Behälter Edelstahl Gn 1/3  
 Contenedor GN 1/3

### Inox 18/10 - St. Steel

	Cm	H Cm	Sp. Mm
V01 05 72 G13	32,5x17,6	2	0,7
V01 05 72 G13A	32,5x17,6	4	0,7
V01 05 72 G13B	32,5x17,6	6,5	0,7
V01 05 72 G13C	32,5x17,6	10	0,7
V01 05 72 G13D	32,5x17,6	15	0,7
V01 05 72 G13E	32,5x17,6	20	0,7



**Contentitore GN 1/4**

GN 1/4 container

Conteneur GN 1/4

GN Behälter Edelstahl Gn 1/4

Contenedor GN 1/4

**Inox 18/10 - St. Steel**

	Cm	H Cm	Sp. Mm
V01 05 72 G14	26,5x16,2	2	0,7
V01 05 72 G14A	26,5x16,2	4	0,7
V01 05 72 G14B	26,5x16,2	6,5	0,7
V01 05 72 G14C	26,5x16,2	10	0,7
V01 05 72 G14D	26,5x16,2	15	0,7
V01 05 72 G14E	26,5x16,2	20	0,7

**Contentitore GN 1/6**

GN 1/6 container

Conteneur GN 1/6

GN Behälter Edelstahl Gn 1/6

Contenedor GN 1/6

**Inox 18/10 - St. Steel**

	Cm	H Cm	Sp. Mm
V01 05 72 G16	17,6x16,2	2	0,7
V01 05 72 G16A	17,6x16,2	4	0,7
V01 05 72 G16B	17,6x16,2	6,5	0,7
V01 05 72 G16C	17,6x16,2	10	0,7
V01 05 72 G16D	17,6x16,2	15	0,7
V01 05 72 G16E	17,6x16,2	20	0,7

**Contentitore GN 1/9**

GN 1/9 container

Conteneur GN 1/9

GN Behälter Edelstahl Gn 1/9

Contenedor GN 1/9

**Inox 18/10 - St. Steel**

	Cm	H Cm	Sp. Mm
V01 05 72 G19A	17,6x10,8	4	0,7
V01 05 72 G19B	17,6x10,8	6,5	0,7
V01 05 72 G19C	17,6x10,8	10	0,7



## Separatore GN

GN adaptor bars  
GN Barrette de composition  
Separator GN  
Perfiles divisorios GN

### Inox 18/10 - St. Steel

	GN
V01 05 72 SE 11	1/1
V01 05 72 SE 12	1/2



## Falso fondo forato

False perforated bottom  
Faux fond perforè  
Flascher Boden mit Löchern  
Falso hondo perforado

### Inox 18/10 - St. Steel

	GN
V01 05 72 FF 21	2/1
V01 05 72 FF 11	1/1
V01 05 72 FF 23	2/3
V01 05 72 FF 12	1/2



## Maniglia

Handle  
Poignée  
Griff  
Manija

### Inox 18/10 - St. Steel

Z01 10 72 FIV	maniglia fissa verticale
Z01 10 72 RIE	maniglia rientrante

**Teglia GN 2/1**

2/1 GN baking pan

Plat à four GN 2/1

Gastronorm-Blech Edelstahl GN 2/1

Fuente para horno GN 2/1

**Inox 18/10 - St. Steel**

	Cm	H Cm	Sp. Mm
V01 05 26 G21	65x53	2	0,7
V01 05 26 G21A	65x53	4	0,7
V01 05 26 G21B	65x53	6,5	0,7

**Teglia GN 1/1**

1/1 GN baking pan

Plat à four GN 1/1

Gastronorm-Blech Edelstahl GN 1/1

Fuente para horno GN 1/1

**Inox 18/10 - St. Steel**

	Cm	H Cm	Sp. Mm
V01 05 26 G110	53x32,5	1	0,7
V01 05 26 G11	53x32,5	2	0,7
V01 05 26 G11A	53x32,5	4	0,7
V01 05 26 G11B	53x32,5	6,5	0,7

**Teglia GN 1/2**

1/2 GN baking pan

Plat à four GN 1/2

Gastronorm-Blech Edelstahl GN 1/2

Fuente para horno GN 1/2

**Inox 18/10 - St. Steel**

	Cm	H Cm	Sp. Mm
V01 05 26 G12	32,5x26,5	2	0,7
V01 05 26 G12A	32,5x26,5	4	0,7
V01 05 26 G12B	32,5x26,5	6,5	0,7

**Teglia GN 2/3**

2/3 GN baking pan

Plat à four GN 2/3

Gastronorm-Blech Edelstahl GN 2/3

Fuente para horno GN 2/3

**Inox 18/10 - St. Steel**

	Cm	H Cm	Sp. Mm
V01 05 26 G23	35,4x32,5	2	0,7
V01 05 26 G23A	35,4x32,5	4	0,7
V01 05 26 G23B	35,4x32,5	6,5	0,7





## Coperchio GN

GN lid  
Couvercle GN  
GN Deckel  
Tapa GN

### Inox 18/10 - St. Steel

	GN	Cm	Sp. Mm
V01 05 15 G11	1/1	53x32,5	0,7
V01 05 15 G23	2/3	35,4x32,5	0,7
V01 05 15 G12	1/2	32,5x26,5	0,7
V01 05 15 G13	1/3	32,5x17,6	0,7
V01 05 15 G14	1/4	26,5x16,2	0,7
V01 05 15 G16	1/6	17,6x16,2	0,7
V01 05 15 G19	1/9	17,6x10,8	0,7
V01 05 15 G24	2/4	16,2x53	0,7



### Con asola/with hole

	GN	Cm	Sp. Mm
V01 05 15 GM11	1/1	53x32,5	0,7
V01 05 15 GM12	1/2	32,5x26,5	0,7
V01 05 15 GM13	1/3	32,5x17,6	0,7
V01 05 15 GM14	1/4	26,5x16,2	0,7
V01 05 15 GM16	1/6	17,6x16,2	0,7
V01 05 15 GM19	1/9	17,6x10,8	0,7
V01 05 15 GM23	2/3	35,4x32,5	0,7
V01 05 15 GM24	2/4	16,2x53	0,7



### Cooperchio con guarnizione in silicone

	GN	Cm	Sp. Mm
V010515GG11	1/1	53x32,5	0,7
V010515GG23	2/3	35,4x32,5	0,7
V010515GG12	1/2	32,5x26,5	0,7
V010515GG13	1/3	32,5x17,6	0,7
V010515GG14	1/4	26,5x16,2	0,7
V010515GG16	1/6	17,6x16,2	0,7



**Vaschetta gelato GN**

GN ice cream pan

Bac à glace GN

Eisschale GN

Cubeta helado GN

**Inox 18/10 - St. Steel**

	Cm	H Cm
V01 05 72 IO 412	16,5x36	12

**Bacinella forata (fondo + lati)**

Perforated basin (bottom + sides)

Bacs perforè (fond + côtés)

Schüssel mit Löchern (Boden + Seiten)

Bandejas honda perforada (fondo y lados)

**Inox 18/10 - St. Steel**

	H Cm	H In	GN
V01 05 72 GF 11BL	6,5	2,1/2	1/1
V01 05 72 GF 11C	10	4	1/1
V01 05 72 GF 11D	15	6	1/1
V01 05 72 GF 11E	20	7,7/8	1/1
V01 05 72 GF 12C	10	4	1/2
V01 05 72 GF 12D	15	6	1/2
V01 05 72 GF 12E	20	7,7/8	1/2

**Bacinella forata (solo fondo)**

Perforated basin (bottom only)

Bacs perforè (fond seulement)

Schüssel mit Löchern (nur Boden)

Bandejas honda perforada (solo el fondo)

**Inox 18/10 - St. Steel**

	H Cm	H In	GN
V01 05 72 GF 21	2	0,3/4	2/1
V01 05 72 GF 21A	4	1,1/2	2/1
V01 05 72 GF 21B	6,5	2,1/2	2/1
01 05 72 GF 11	2	0,3/4	1/1
V01 05 72 GF 11A	4	1,1/2	1/1
V01 05 72 GF 11B	6,5	2,1/2	1/1
V01 05 72 GF 12	2	0,3/4	1/2
V01 05 72 GF 12A	4	1,1/2	1/2
V01 05 72 GF 12B	6,5	2,1/2	1/2
V01 05 72 GF 13	2	0,3/4	1/3
V01 05 72 GF 13A	4	1,1/2	1/3
V01 05 72 GF 13B	6,5	2,1/2	1/3
V01 05 72 GF 23	2	0,3/4	2/3
V01 05 72 GF 23A	4	1,1/2	2/3
V01 05 72 GF 23B	6,5	2,1/2	2/3



**Contentore GN 2/1**

GN 2/1 container  
 Conteneur GN 2/1  
 GN Behälter GN 2/1  
 Contenedor GN 2/1

**Policarbonato - Polycarbonate**

	Cm	H Cm
V01 PC 72 G11 E	65x53	20

**Contentore GN 1/1**

GN 1/1 container  
 Conteneur GN 1/1  
 GN Behälter GN 1/1  
 Contenedor GN 1/1

**Policarbonato - Polycarbonate**

	Cm	H Cm
V01 PC 72 G11 B	53x32,5	6,5
V01 PC 72 G11 C	53x32,5	10
V01 PC 72 G11 D	53x32,5	15
V01 PC 72 G11 E	53x32,5	20

**Contentore GN 1/2**

GN 1/2 container  
 Conteneur GN 1/2  
 GN Behälter GN 1/2  
 Contenedor GN 1/2

**Policarbonato - Polycarbonate**

	Cm	H Cm
V01 PC 72 G12 B	32,5x26,5	6,5
V01 PC 72 G12 C	32,5x26,5	10
V01 PC 72 G12 D	32,5x26,5	15
V01 PC 72 G12 E	32,5x26,5	20

**Contentore GN 1/3**

GN 1/3 container  
 Conteneur GN 1/3  
 GN Behälter GN 1/3  
 Contenedor GN 1/3

**Policarbonato - Polycarbonate**

	Cm	H Cm
V01 PC 72 G13 B	32,5x17,6	6,5
V01 PC 72 G13 C	32,5x17,6	10
V01 PC 72 G13 D	32,5x17,6	15
V01 PC 72 G13 E	32,5x17,6	20



**Contenitore GN 1/4**

GN 1/4 container  
 Conteneur GN 1/4  
 GN Behälter GN 1/4  
 Contenedor GN 1/4

**Policarbonato - Polycarbonate**

	Cm	H Cm
V01 PC 72 G14 B	26,5x16,2	6,5
V01 PC 72 G14 C	26,5x16,2	10
V01 PC 72 G14 D	26,5x16,2	15
V01 PC 72 G14 E	26,5x16,2	20

**Contenitore GN 1/6**

GN 1/6 container  
 Conteneur GN 1/6  
 GN Behälter GN 1/6  
 Contenedor GN 1/6

**Policarbonato - Polycarbonate**

	Cm	H Cm
V01 PC 72 G16 B	17,6x16,2	6,5
V01 PC 72 G16 C	17,6x16,2	10
V01 PC 72 G16 D	17,6x16,2	15
V01 PC 72 G16 E	17,6x16,2	20

**Contenitore GN 1/9**

GN 1/9 container  
 Conteneur GN 1/9  
 GN Behälter GN 1/9  
 Contenedor GN 1/9

**Policarbonato - Polycarbonate**

	Cm	H Cm
V01 PC 72 G19 B	17,6x10,8	6,5
V01 PC 72 G19 C	17,6x10,8	10

**Vaschetta gelato GN**

GN ice cream pan  
 Bac à glace GN  
 Eisschale GN  
 Cubeta helado GN

**Policarbonato - Polycarbonate**

	Cm	H Cm
V01 PC 72 GGE	16,5x36	12



## Coperchio

Lid  
Couvercle  
Deckel  
Tapa

### Policarbonato - Polycarbonate

	Cm	GN
V01 PC 15 G21	65x53	2/1
V01 PC 15 G11	53x32,5	1/1
V01 PC 15 G12	32,5x26,5	1/2
V01 PC 15 G13	32,5x17,6	1/3
V01 PC 15 G14	26,5x16,2	1/4
V01 PC 15 G16	17,6x16,2	1/6
V01 PC 15 G19	17,6x10,8	1/9



## Coperchio GN ermetico

GN hermetic lid  
Couvercle hermétique GN  
Hermetische Deckel GN  
Tapa GN hermética

### Policarbonato - Polycarbonate

	GN	Cm
V01 PC 15 GE11	1/1	53x32,5
V01 PC 15 GE12	1/2	32,5x26,5
V01 PC 15 GE13	1/3	32,5x17,6
V01 PC 15 GE14	1/4	26,5x16,2
V01 PC 15 GE16	1/6	17,6x16,2
V01 PC 15 GE19	1/9	17,6x10,8



## Coperchio

Lid  
Couvercle  
Deckel  
Tapa

### Polipropilene - Polypropylene

	Cm	GN
V01 PP 15 G11	53x32,5	1/1
V01 PP 15 G12	32,5x26,5	1/2
V01 PP 15 G13	32,5x17,6	1/3
V01 PP 15 G14	26,5x16,2	1/4
V01 PP 15 G16	17,6x16,2	1/6
V01 PP 15 G19	17,6x10,8	1/9



**Contentore GN 1/1**

GN 1/1 container  
 Conteneur GN 1/1  
 GN Behälter Gn 1/1  
 Contenedor GN 1/1

**Polipropilene - Polypropylene**

	Cm	H Cm
V01 PP 72 G11 B	53x32,5	6,5
V01 PP 72 G11 C	53x32,5	10
V01 PP 72 G11 D	53x32,5	15
V01 PP 72 G11 E	53x32,5	20

**Contentore GN 1/2**

GN 1/2 container  
 Conteneur GN 1/2  
 GN Behälter Gn 1/2  
 Contenedor GN 1/2

**Polipropilene - Polypropylene**

	Cm	H Cm
V01 PP 72 G12 B	32,5x26,5	6,5
V01 PP 72 G12 C	32,5x26,5	10
V01 PP 72 G12 D	32,5x26,5	15
V01 PP 72 G12 E	32,5x26,5	20

**Contentore GN 1/3**

GN 1/3 container  
 Conteneur GN 1/3  
 GN Behälter Gn 1/3  
 Contenedor GN 1/3

**Polipropilene - Polypropylene**

	Cm	H Cm
V01 PP 72 G13 B	32,5x17,6	6,5
V01 PP 72 G13 C	32,5x17,6	10
V01 PP 72 G13 D	32,5x17,6	15
V01 PP 72 G13 E	32,5x17,6	20

**Contentore GN 1/4**

GN 1/4 container  
 Conteneur GN 1/4  
 GN Behälter Gn 1/4  
 Contenedor GN 1/4

**Polipropilene - Polypropylene**

	Cm	H Cm
V01 PP 72 G14 B	26,5x16,2	6,5
V01 PP 72 G14 C	26,5x16,2	10
V01 PP 72 G14 D	26,5x16,2	15
V01 PP 72 G14 E	26,5x16,2	20



**Contentore GN 1/6**

GN 1/6 container  
 Conteneur GN 1/6  
 GN Behälter Gn 1/6  
 Contenedor GN 1/6

**Polipropilene - Polypropylene**

	Cm	H Cm
V01 PP 72 G16 B	17,6x16,2	6,5
V01 PP 72 G16 C	17,6x16,2	10
V01 PP 72 G16 D	17,6x16,2	15
V01 PP 72 G16 E	17,6x16,2	20

**Contentore GN 1/9**

GN 1/9 container  
 Conteneur GN 1/9  
 GN Behälter Gn 1/9  
 Contenedor GN 1/9

**Polipropilene - Polypropylene**

	Cm	H Cm
V01 PP 72 G19 B	17,6x10,8	6,5
V01 PP 72 G19 C	17,6x10,8	10

**Vaschetta gelato GN**

GN ice cream pan  
 Bac à glace GN  
 Eisschale, übereinander legbar  
 Cubeta helado GN

**Polipropilene - Polypropylene**

	Cm	H Cm
V01 PP 72 GGE	16,5x36	12

**Falso fondo forato**

False perforated bottom  
 Faux fond perforé  
 Flascher Boden mit Löchern  
 Falso fondo perforado

**Polipropilene - Polypropylene**

	GN
V01 PP 72 FF11	1/1
V01 PP 72 FF12	1/2
V01 PP 72 FF13	1/3
V01 PP 72 FF16	1/6

**Trinciapollo manico pom rivettato**

Shears, pom riveted handle

Ciseaux à volailles manche POM riveté

Geflügel Schere mit genietetem Heft

Tijeras para aves mango pom remachado

**Acciaio inossidabile - St. Steel**

AVARI 110

**Trinciapollo manico cavo**

Shears, hollow handle

Tijeras para aves mango hueco

Geflügel Schere mit hohem Heft

Ciseaux à volailles manche creuse

**Acciaio Inox AISI 420**

AVARI 111

**Spillone pizzeria**

Pizza pin

Épingle pour commandes pizzeria

Pizzeria Stecknadel

Agujón para hojas pedidos pizzeria

**Acciaio inossidabile - St. Steel**

AVARI 086

**Campanello reception**

Reception bell

Sonette de réception

Hotelglocke

Timbre recepción

**Acciaio inossidabile - St. Steel**

AVARI 112





**Schiumarola unipezzo**

Skimmer, one piece  
 Ecumoire en une pièce  
 Schaumlöffel einteilig  
 Espumadera de una sola pieza

**Acciaio inossidabile - St. Steel**

	∅ Cm	∅ In
903 06 81 US1	11	4,3/8
903 06 81 US3	13	5,1/8

**Mestolo unipezzo**

Soup, one piece  
 Louche en une pièce  
 Schopflöffel einteilig  
 Cazo sopa de una sola pieza

**Acciaio inossidabile - St. Steel**

	∅ Cm	∅ In
903 06 81 UM9	9	3,1/2
903 06 81 UM1	10	4

**Mestolino unipezzo**

Sauce ladle, one piece  
 Louche à sauce en une pièce  
 Schopflöffel klein einteilig  
 Cacillo salsa de una sola pieza

**Acciaio inossidabile - St. Steel**

	L Cm	L In
903 06 81 UMS	28	11

**Pala fritto unipezzo**

Frying palette, one piece  
 Pelle frittura en une pièce  
 Schaufel einteilig  
 Pala frito de una sola pieza

**Acciaio inossidabile - St. Steel**

	L Cm	L In
903 06 81 UFR	36,5	14,3/8

**Cucchiaione unipezzo**

Serving spoon, one piece  
 Cuillère à servir en une pièce  
 Löffel einteilig  
 Cucharón servir de una sola pieza

**Acciaio inossidabile - St. Steel**

	L Cm	L In
903 06 81 UCU	40	15,3/4

**Forchettone unipezzo**

Serving fork, one piece  
 Fourchette à servir en une pièce  
 Gabel einteilig  
 Tenedor servir de una sola pieza

**Acciaio inossidabile - St. Steel**

	L Cm	L In
903 06 81 UFO	36	14,1/8



**Molla ghiaccio deluxe**

De luxe ice tongs  
Pince à glaçons de luxe  
Eiszange de luxe  
Pinzas hielo de luxe

**Acciaio inossidabile - St. Steel**

	Cm	In
903 06 81 MGD	15,6	6,1/8

**Molla pane**

Bread tongs  
Pince à pain  
Brotzange  
Pinzas pan

**Acciaio inossidabile - St. Steel**

	Cm	In
903 06 81 MPA	20	7,7/8

**Molla spaghetti**

Spaghetti tongs  
Pince à spaghetti  
Spaghetizange  
Pinzas spaghetti

**Acciaio inossidabile - St. Steel**

	Cm	In
903 06 81 MSP	20,2	7,7/8

**Molla dolci**

Cake tongs  
Pince à gâteau  
Gebäckzange  
Pinzas postre

**Acciaio inossidabile - St. Steel**

	Cm	In
903 06 81 MDL	18,9	7,1/2

**Molla arrosto**

Roast tongs  
Pince à rôti  
Fleisch/Servierzange  
Pinzas asado

**Acciaio inossidabile - St. Steel**

	Cm	In
903 06 81 MAR	21	8,1/4

**Molla universale**

Universal tongs  
Pince universelle  
Universalzange  
Pinzas universales

**Acciaio inossidabile - St. Steel**

	Cm	In
903 06 81 MUN	23,5	9,1/4



**Molla zucchero**

Sugar tongs  
Pince à sucre  
Zuckerzange  
Pinzas azucar

**Acciaio inossidabile - St. Steel**

	Cm	In
903 06 81 MZU	14,1	5,1/2

**Molla ghiaccio piccola**

Small ice tongs  
Pince à glaçons petite  
Eiszange - klein  
Pinzas hielo pequeñas

**Acciaio inossidabile - St. Steel**

	Cm	In
903 06 81 MGP	11,8	4,3/4

**Forbici insalata**

Salad tongs (scissors type)  
Pince ciseaux à salade  
Salatzange  
Pinzas ensalada tipo tijeras

**Acciaio inossidabile - St. Steel**

	Cm	In
903 06 81 FIN	20	7,7/8

**Forbici dolci**

Cake tongs (scissors type)  
Pince ciseaux à gâteaux  
Scherenzange  
Pinzas postre tipo tijeras

**Acciaio inossidabile - St. Steel**

	Cm	In
903 06 81 FDO	19,5	7,5/8

**Molla gastronomica**

Culinary tongs  
Pince culinaire  
Gastronomischer Frühling  
Pinzas culinario

**Inox 18/10 - St. Steel**

	Mm	In
CI 180 00	155	6,1/8

**Molla affettati**

Salami tongs  
Pince charcuterie  
Wurstwarenfeder  
Pinzas charcutería

**Acciaio inossidabile - St. Steel**

	Mm	In
903 05 81 MAF C1	105	4,1/8





### Bastardella

Bowl  
Bol  
Edelstahl 18/10 Schale "Bastardella"  
Bol

#### Acciaio Inox 18/10 - St.steel

	ø Cm	H Cm	ø In	H In
V01 05 43 B 26	26	16,2	10,1/4	6,1/4
V01 05 43 B 22	22	16,2	8,5/8	6,1/4



### Supporto per bastardella

Bowl stand  
Support pour bol  
Halter für Schale  
Soparte para bol

#### Acciaio Inox 18/10 - St.steel

	ø Cm	H Cm	ø In	H In
Z01 19 43 B 22	16	3	6,1/4	1,1/8



## Ciotola Imperial

Bowl  
Bol  
Bol  
Schale

### Inox 18/10 - St. Steel

	Cm	In
V01 05 43 I16	16	6,1/4
V01 05 43 I18	18	7
V01 05 43 I20	20	7,7/8
V01 05 43 I22	22	8,5/8
V01 05 43 I24	24	9,1/2
V01 05 43 I28	28	11
V01 05 43 I32	32	12,5/8



## Ciotola

Bowl  
Bol  
Bol  
Schale

### Inox 18/10 - St. Steel

	ø Cm	ø In	Lt
AVARI 049	12	4,3/4	0,5
AVARI 052	16	6,1/4	1
AVARI 050	20	7,7/8	2
AVARI 053	23	9,8/8	3
AVARI 051	26	10,1/4	4
AVARI 054	29	11,1/2	5,5



## Carapina Professionale

Ice cream professional container  
Conteneur à glace professionnel  
Contenedor helado profesional  
Eis Behälter, profi

### Inox 18/10 - St. Steel

	ø Cm	H Cm	ø In	H In
V01 05 72 GGE	20	23,5	7,7/8	9,1/4



## Vassoio pasticceria

Confectionery tray  
Plateau à pâtisserie  
Konditoreiplatte  
Bandeja p/pasteleria

### Inox 18/10 - St. Steel

	Cm	In
CI 5601	25x18	9,7/8x7
CI 5602	30x22	11,3/4x8,5/8



## Lasagnera

Lasagna tray  
Plat à four  
Lasagnepfanne  
Lasañera

### Inox 18/10 - St. Steel

	Cm	In
V03 06 26 026	26,5x19,5	10,3/8x7,5/8
V03 06 26 031	31,5x24	12,3/8x9,1/2
V03 06 26 037	37x27	14,1/2x10,5/8
V03 06 26 040	42x30,5	16,1/2x12







**abert** BY Promab

**Mestolo**

Ladle  
Louche  
Suppenlöffel  
Cazo

**Nylon PA 6,6 FG 10%**

	Cm	In
● 903 12 81 C15 ME	32	12,5/8
● 903 12 81 C47 ME	32	12,5/8

**Schiumarola**

Skimmer  
Ecumoire  
Schaumlöffel  
Espumadera

**Nylon PA 6,6 FG 10%**

	Cm	In
● 903 12 81 C15 SC	35	13,3/4
● 903 12 81 C47 SC	35	13,3/4

**Pala fritto**

Frying shovel  
Pelle à friture  
Schaufel  
Pala para freir

**Nylon PA 6,6 FG 10%**

	Cm	In
● 903 12 81 C15 FR	35	13,3/4
● 903 12 81 C47 FR	35	13,3/4

**Paletta**

Showel  
Pelle  
Schaufel  
Pala

**Nylon PA 6,6 FG 10%**

	Cm	In
● 903 12 81 C15 PA1	35	13,3/4
● 903 12 81 C47 PA1	35	13,3/4

**Cucchiaine forato**

Slotted spoon  
Cuillère à servir perforée  
Gelochte Servierlöffel  
Cucharón perforado

**Nylon PA 6,6 FG 10%**

	Cm	In
● 903 12 81 C15 CUF	35	13,3/4
● 903 12 81 C47 CUF	35	13,3/4

**Cucchiaine**

Serving spoon  
Cuillère à servir  
Servierlöffel  
Cucharón

**Nylon PA 6,6 FG 10%**

	Cm	In
● 903 12 81 C15 CU	35	13,3/4
● 903 12 81 C47 CU	35	13,3/4





### Servispaghetti

Spaghetti serving spoon  
Louche à spaghetti  
Servierlöffel für Spaghetti  
Cucharón para spaghetti

**Nylon PA 6,6 FG 10%**

	Cm	In
● 903 12 81 C15 SP	33,4	13,1/4
● 903 12 81 C47 SP	33,4	13,1/4



### Paletta

Shovel  
Pelle  
Schaufel  
Pala

**Nylon PA 6,6 FG 10%**

	Cm	In
● 903 12 81 C15 PA2	32	12,5/8
● 903 12 81 C47 PA2	32	12,5/8



### Paletta forata

Perforated shovel  
Pelle perforée  
Gelochte Schaufel  
Pala perforada

**Nylon PA 6,6 FG 10%**

	Cm	In
● 903 12 81 C15 PAF	31,5	12,3/8
● 903 12 81 C47 PAF	31,5	12,3/8



### Paletta fritto

Frying shovel  
Pelle à friture  
Schaufel  
Pala para freir

**Nylon PA 6,6 FG 10%**

	Cm	In
● 903 12 81 C15 PAA	32	12,5/8
● 903 12 81 C47 PAA	32	12,5/8



### Pinza chef

Chef tongs  
Pince chef  
Chef Zange  
Pinzas de chef

**Nylon PA 6,6 FG 10%**

	Cm	In
● 903 12 81 C15 PI	30,5	12
● 903 12 81 C47 PI	30,5	12



### Paletta scolatutto

Draining spoon  
Cuillère à égoutter  
Schaumschaufel  
Cuchara para colar

**Nylon PA 6,6 FG 10%**

	Cm	In
● 903 12 81 C15 PFG	38	15
● 903 12 81 C47 PFG	38	15



**Molla toast/dolce**

Toast/cake tongs  
Pince à gâteaux  
Kuchenschaufel  
Pinzas postre

**Nylon PA 6,6 FG 10%**

	Cm	In
● 903 12 81 C15 MD	28	11
● 903 12 81 C47 MD	28	11

**Molla insalata**

Salad tongs  
Pince à salade  
Salatschaufel  
Pinzas ensalad

**Nylon PA 6,6 FG 10%**

	Cm	In
● 903 12 81 C15 MI	31	12,1/4
● 903 12 81 C47 MI	31	12,1/4



**Padella 1 manico**

Frying pan, 1-handle  
Poêle avec 1 manches  
Mit Griff Pfanne  
Sartén un mangos

**Alluminio con fondo a induzione**  
**Aluminium with induction bottom**

	∅ Cm	∅ In	H Cm	H In
V67 11 72 PA24	24	9,1/2	6	2,3/8
V67 11 72 PA28	28	11	7	2,3/4
V67 11 72 PA32	32	12,5/8	7,5	3
V67 11 72 PA36	36	14,1/8	8	3,1/8
V67 11 72 PA40	40	15,3/4	8,5	3,3/8



**Pentola 2 manici**

Pot, 2-handle  
Casserole avec 2 manches  
Mit 2 Griffen Topf  
Olla dos mangos

**Alluminio con fondo a induzione**  
**Aluminium with induction bottom**

	∅ Cm	∅ In	H Cm	H In	Lt	Oz
V67 11 72 PE28	28	11	15	6	8	270
V67 11 72 CA32	32	12,5/8	11,5	4,1/2	9	304

casseruola | casserole



**Tegame 2 manici**

Frying pan, 2 - handle  
Poêlon avec 2 manches  
Mit 2 Griffen Flache Kochtopf  
Olla dos mangos

**Alluminio con fondo a induzione**  
**Aluminium with induction bottom**

	∅ Cm	∅ In	H Cm	H In
V67 11 72 TE24	24	9,1/2	6	2,3/8
V67 11 72 TE28	28	11	7	2,3/4
V67 11 72 TE32	32	12,5/8	7,5	3
V67 11 72 TE36	36	14,1/8	8	3,1/8
V67 11 72 TE40	40	15,3/4	8,5	3,3/8



**Wok antiaderente**

Wok, non-stick  
Wok anti-adhésif  
Wok mit einem Griff  
Wok antiadherente

**Alluminio con fondo a induzione**  
**Aluminium with induction bottom**

	ø Cm	ø In	H	Hin
V68 11 72 WO 26	26	10,1/4	7,8	3
V68 11 72 WO 28	28	11	7,8	3
V68 11 72 WO 30	30	11,3/4	8,8	3,1/2

**Casseruola 2 manici**

Casserole, 2-handle  
Casserole à 2 manches  
Kasserolle mit 2 Griffen  
Cacerola 2 mangos

**Alluminio con fondo a induzione**  
**Aluminium with induction bottom**

	ø Cm	ø In	H Cm	H in	lt
V68 11 72 CA 20A	20	7,7/8	8,8	3,1/2	2,8
V68 11 72 CA 22	22	8,5/8	9,2	3,1/2	3,5
V68 11 72 CA 24	24	9,1/2	10,7	4,1/8	4,8
V68 11 72 CA 26	26	10,1/4	11,8	4,3/4	6,2
V68 11 72 CA 28	28	11	12	4,3/4	7,4
V68 11 72 CA 32	32	12,5/8	12	4,3/4	9,5

**Casseruola 1 manico**

Casserole, 1-handle  
Casserole à 1 manche  
Kasserolle mit einem Griff  
Cacerola 1 mango

**Alluminio con fondo a induzione**  
**Aluminium with induction bottom**

	ø Cm	ø In	H Cm	H in	lt
V68 11 72 2CA 14	14	5,1/2	7	2,3/4	1
V68 11 72 2CA 16	16	6,1/4	8	3,1/8	1,6
V68 11 72 2CA 18	18	7	8,8	3,1/2	2,2
V68 11 72 2CA 20	20	7,7/8	8,8	3,1/2	2,8



**Padella antiaderente 1 manico**

Frying pan, non-stick 1-handle  
Poêle antiadhérente avec 1 manches  
Mit Griff Pfanne  
Sartén antiadherente un mangos

**Alluminio con fondo a induzione**  
**Aluminium with induction bottom**

	∅ Cm	∅ In	H Cm	H In
V68 11 72 PA20	20	7,7/8	4,3	1,3/4
V68 11 72 PA22	22	8,5/8	4,3	1,3/4
V68 11 72 PA24	24	9,1/2	6	2,3/8
V68 11 72 PA28	28	11	7	2,3/4
V68 11 72 PA32	32	12,5/8	7,5	3
V68 11 72 PA36	36	14,1/8	8	3,1/8
V68 11 72 PA40	40	15,3/4	8,5	3,3/8



**Pentola antiaderente 2 manici**

Pot, non-stick 2-handle  
Casserole antiadhérente avec 2 manches  
Mit 2 Griffen Topf  
Olla antiadherente dos mangos

**Alluminio con fondo a induzione**  
**Aluminium with induction bottom**

	∅ Cm	∅ In	H Cm	H In	Lt	Oz
V68 11 72 PE28	28	11	15	6	8	270



**Tegame antiaderente 2 manici**

Pot, non stick 2 - handle  
Casserole antiadhérente avec 2 manches  
Mit 2 Griffen Flache Kochtopf  
Olla antiadherente dos mangos

**Alluminio con fondo a induzione**  
**Aluminium with induction bottom**

	∅ Cm	∅ In	H Cm	H In
V68 11 72 TE24	24	9,1/2	6	2,3/8
V68 11 72 TE28	28	11	7	2,3/4
V68 11 72 TE32	32	12,5/8	7,5	3
V68 11 72 TE36	36	14,1/8	8	3,1/8
V68 11 72 TE40	40	15,3/4	8,5	3,3/8



**Coltello chef**

Chef knife  
Couteau chef  
Chefmesser  
Cuchillo cocinero

**Acciaio inossidabile - St. Steel+ ABS**

	Cm	In
V67 06 91 001	15	6
V67 06 91 002	20	7,7/8
V67 06 91 025	23	9
V67 06 91 026	25	9,7/8

**Coltello pane**

Bread knife  
Couteau pain  
Brottmesser  
Cuchillo pan

**Acciaio inossidabile - St. Steel+ ABS**

	Cm	In
V67 06 91 003	20	7,7/8

**Coltello affettare**

Slicing knife  
Couteau pour coupe en tranches  
Messer zum Aufschneiden  
Cuchillo para filetear

**Acciaio inossidabile - St. Steel+ ABS**

	Cm	In
V67 06 91 004	20	7,7/8

**Coltello utility**

Utility knife  
Couteau de service  
Utility-Messer  
Cuchillo universal

**Acciaio inossidabile- St. Steel+ ABS**

	Cm	In
V67 06 91 009	14	5,1/2

**Coltello santoku**

Santoku knife  
Couteau Santoku  
Santoku Profimesser  
Cuchillo Santoku

**Acciaio inossidabile - St. Steel+ ABS**

	Cm	In
V67 06 91 005	12,5	5
V67 06 91 006	18	7

**Coltello disossare**

Boning knife  
Couteau à désosser  
Messer zum Entbeinen  
Cuchillo deshuesador

**Acciaio inossidabile - St. Steel+ ABS**

	Cm	In
V67 06 91 007	16	6,1/4



**Mannaretta**

Cleaver  
Couperet  
Hackbeil Messer  
Cuchillo de carnicero

**Acciaio inossidabile - St. Steel+ ABS**

	Cm	In
V67 06 91 027	18	7



**Affilacoltelli professionale**

Professional sharpener  
Aiguiseur à couteaux  
Schleifmittel  
Afilador de cuchillos

**Acciaio inossidabile - St. Steel+ ABS**

	Cm	In
V67 06 91 012	20	7,7/8



**Coltello professionale Utility**

Professional Utility knife  
Couteau de service dentelé  
Utility-Messer  
Cuchillo universal dentado

**Acciaio inossidabile - St. Steel+ ABS**

	Cm	In
V67 06 91 008	11,5	4,1/2



**Coltello spelucchino**

Paring knife  
Couteau à éplucher  
Schälmesser  
Cuchillo guarnecer

**Acciaio inossidabile - St. Steel+ ABS**

	Cm	In
V67 06 91 010	8,8	3,1/2



**Coltello professionale frutta**

Professional fruit knife  
Couteau à fruits  
Obstmesser  
Cuchillo frutas

**Acciaio inossidabile - St. Steel+ ABS**

	Cm	In
V67 06 91 011	8,8	3,1/2



**Cestino pane**

Square bread basket  
Corbeille à pain carré  
Viereckiger Brotkorb  
Cesta pan cuadrado

	Cm	H Cm	In	H In
<b>Marrone - Brown</b>				
AVARI 200	14x14	8	5,1/2x5,1/2	3,1/8
AVARI 203	19x19	10	7,1/2x7,1/2	4
<b>Beige - Ecrù</b>				
AVARI 201	14x14	8	5,1/2x5,1/2	3,1/8
AVARI 204	19x19	10	7,1/2x7,1/2	4
<b>Juta - Juta</b>				
AVARI 202	14x14	8	5,1/2x5,1/2	3,1/8
AVARI 205	19x19	10	7,1/2x7,1/2	4

**Cestino portabustine mignon**

Tea/Sugar bag basket, small  
Corbeille à sachets de thé/sucre petite  
Klein Stoffkorb, Tee und Zuckerbeutelbehälter  
Cestita para bolsitas de té/azúcar pequeña

	Cm	H Cm	In	H In
<b>Marrone - Brown</b>				
AVARI 208	6x8	6	2,3/8x3,1/8	2,3/8
<b>Beige - Ecrù</b>				
AVARI 209	6x8	6	2,3/8x3,1/8	2,3/8
<b>Juta</b>				
AVARI 210	6x8	6	2,3/8x3,1/8	2,3/8

**Sacchetto porta pane**

Bread basket  
Corbeille à pain  
Brotkorb  
Cesta pan

	ø Cm	H Cm	ø In	H In
<b>Marrone - Brown</b>				
AVARI 206	21	25	8,1/4	9,7/8
<b>Beige - Ecrù</b>				
AVARI 207	21	25	8,1/4	9,7/8

**Cuscino termico**

Thermal cushion  
Coussin chauffant  
Wärmekissen  
Cojín térmico

	Cm	In
325 05 24 579	13x13	5,1/8x5,1/8
325 05 24 580	18x18	7x7





**Cestino pane**

Bread basket  
Corbeille à pain  
Brotkorb  
Cesta pan

	Cm	H Cm	In	H In
<b>Marrone - Brown</b>				
305 29 24 581	12x12	14,5	5x5	5,3/4
305 29 24 582	18x18	18	7x7	7
<b>Beige - Ecrù</b>				
305 29 24 583	12x12	14,5	5x5	5,3/4
305 29 24 584	18x18	18	7x7	7

**Cuscino termico**

Thermal cushion  
Coussin chauffiant  
Wärmekissen  
Cojín térmico

	Cm	In
325 05 24 579	13x13	5,1/8x5,1/8
325 05 24 580	18x18	7x7



**Cestino pane tessuto con cuscino**

Bread basket with cushion  
Corbeille à pain avec coussin  
Brotkorb mit Kissen  
Cesta pan con cosin

	Cm	H Cm	In	H In
<b>Marrone - Brown</b>				
AVARI 151	12x12	14,5	5x5	5,3/4
AVARI 153	18x18	18	7x7	7
<b>Beige - Ecrù</b>				
AVARI 150	12x12	14,5	5x5	5,3/4
AVARI 152	18x18	18	7x7	7



**Cestino pane tessuto (senza cuscino)**

Bread basket (without cushion)  
Corbeille à pain (sans coussin)  
Brotkorb (ohne Kissen)  
Cesta pan (sin cosin)

	Cm	H Cm	In	H In	Pz - Pcs
<b>Marrone - Brown</b>					
AVARI 162	12x12	14,5	5x5	5,3/4	1
AVARI 164	18x18	18	7x7	7	1
<b>Beige - Ecrù</b>					
AVARI 161	12x12	14,5	5x5	5,3/4	1
AVARI 163	18x18	18	7x7	7	1
<b>Marrone - Brown</b>					
AVARI 154	12x12	14,5	5x5	5,3/4	3
AVARI 156	18x18	18	7x7	7	2
<b>Beige - Ecrù</b>					
AVARI 155	12x12	14,5	5x5	5,3/4	3
AVARI 157	18x18	18	7x7	7	2



**Brocca ColorStyle**

ColorStyle jug  
 Broc à eau ColorStyle  
 Acryl Kanne Colorstyle  
 Jarra ColorStyle

**Acrilico / Acrilic**

	Lt	Oz
<input type="checkbox"/> V60 12 08 001 13	2	70
<input checked="" type="checkbox"/> V60 12 08 001 00	2	70

**Brocca Diamond**

Diamond jug  
 Broc à eau Diamond  
 Acryl Kanne Diamond  
 Jarra Diamond

**Acrilico / Acrilic**

	Lt	Oz
<input checked="" type="checkbox"/> V60 12 08 003 00	2,5	87,5

**Brocca Elegant**

Elegant jug  
 Broc à eau Elegant  
 Acryl Kanne Elegant  
 Jarra Elegant

**Acrilico / Acrilic**

	Lt	Oz
<input checked="" type="checkbox"/> V60 12 08 004 00	2	70

**Caraffa ColorStyle**

ColorStyle Pitcher  
 Carafe ColorStyle  
 Acryl Karaffe Colorstyle  
 Jarra ColorStyle

**Acrilico / Acrilic**

	Lt	Oz
<input type="checkbox"/> V60 12 08 002 13	1,5	50,7
<input checked="" type="checkbox"/> V60 12 08 002 47	1,5	50,7



**Olierona**

Oil dispenser  
Huilière  
Ölbehälter  
Aceitera grande

**Acciaio inossidabile - St. Steel**

	Lt	Oz
AVARI 071	0,5	17,5
AVARI 072	1,0	35



**Olierona con tappo versatore salvagoccia**

Oil server with drop stop pourer  
Huilier avec bouchon verseur anti-gouttes  
Olivenölbehälter mit Eingießstöpsel, mit Tropfschutzverschluß  
Aceitera con tapón vertedor antigoteo

**Acciaio inox 18|10 / 18|10 St. Steel**

	Lt	Oz
AVARI 400	0,25	9
AVARI 401	0,50	17,5
AVARI 402	0,75	26,5
AVARI 403	1,00	35



### Secchio spumante 1 bottiglia

Champagne bucket, 1-bottle  
Seau à champagne 1 bouteille  
Champagneschale (Für 1Flasche)  
Cubo champán 1 botella

	Cm	H Cm	In	H In
V81 12 20 001 Plex -Transparent	22x16	23,5	8,5/8x6,1/4	9,1/4
V81 12 20 004 PS - Transparent	22x16	23,5	8,5/8x6,1/4	9,1/4
V81 12 20 007 PS Bianco - White	22x16	23,5	8,5/8x6,1/4	9,1/4



### Secchio spumante Magnum

Magnum bucket  
Seau Magnum  
Champagneschale Magnum  
Cubo Magnum

	Cm	H Cm	In	H In
V81 12 20 002 Plex -Transparent	27,9x17,3	23,4	11x6,7/8	9,1/4
V81 12 20 005 PS - Transparent	27,9x17,3	23,4	11x6,7/8	9,1/4
V81 12 20 008 PS Bianco - White	27,9x17,3	23,4	11x6,7/8	9,1/4



### Secchio spumante Jeroboam

Jeroboam bucket  
Seau Jeroboam  
Champagneschale Jeroboam  
Cubo Jeroboam

	Cm	H Cm	In	H In
V81 12 20 003 Plex -Transparent	48,2x20,9	24,3	19x8,1/4	9,5/8
V81 12 20 006 PS - Transparent	48,2x20,9	24,3	19x8,1/4	9,5/8
V81 12 20 009 PS Bianco - White	48,2x20,9	24,3	19x8,1/4	9,5/8



**Runner - grigio scuro**

Runner, dark grey  
Chemin de table gris foncé  
Runner dunkelgrau  
Camino de mesa gris oscuro

**70% Pvc - 30% Pet**

	Cm	In
AVARI TO 31	45x120	17,3/4x47,2



**Runner - grigio chiaro**

Runner, light grey  
Chemin de table gris clair  
Runner hellgrau  
Camino de mesa gris claro

**70% Pvc - 30% Pet**

	Cm	In
AVARI TO 30	45x120	17,3/4x47,2

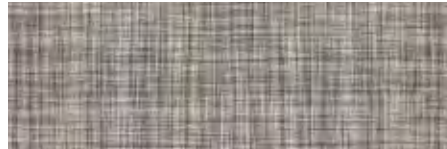

**Runner - grigio tortora**

Runner, taupe  
Chemin de table taupe  
Runner taubegrau  
Camino de mesa gris topo

**70% Pvc - 30% Pet**

	Cm	In
AVARI TO 32	45x120	17,3/4x47,2



**Runner - grigio sabbia**

Runner, sand  
Chemin de table sable  
Runner sandgrau  
Camino de mesa arena

**70% Pvc - 30% Pet**

	Cm	In
AVARI TO 33	45x120	17,3/4x47,2



**Runner - grigio marrone con rettangolo**

Runner, brown with rectangle  
Chemin de table marron avec rectangle  
Runner braungrau rechteckig  
Camino de mesa marrón con rectángulo

**70% Pvc - 30% Pet**

	Cm	In
AVARI TO 34	45x120	17,3/4x47,2



**Tovaglietta - marrone**

Placemat - brown  
 Nappe individuelle marron  
 Klein Tischtuch braun  
 Mantel individual marròn

**Pvc-Pet**

	Cm	In
<b>AVARITO 14</b>	<b>45x30</b>	<b>17,3/4x11,3/4</b>

**Tovaglietta - tortora quadrati**

Placemat - taupe, squares  
 Nappe individuelle taupe carrés  
 KleinTischtuch grau mit quadraten  
 Mantel individual gris topo cuadrados

**Pvc-Pet**

	Cm	In
<b>AVARITO 11</b>	<b>45x30</b>	<b>17,3/4x11,3/4</b>

**Tovaglietta - marrone quadrati**

Placemat brown - squares  
 Nappe individuelle marron carrés  
 Klein Tischtuch braun mit Quadrat  
 Mantel individual marròn cuadrados

**Pvc-Pet**

	Cm	In
<b>AVARITO 12</b>	<b>45x30</b>	<b>17,3/4x11,3/4</b>

**Tovaglietta - bianco**

Placemat - white  
 Nappe individuelle blanc  
 Klein Tischtuch weiss  
 Mantel individual blanco

**Pvc-Pet**

	Cm	In
<b>AVARITO 13</b>	<b>45x30</b>	<b>17,3/4x11,3/4</b>

**Tovaglietta - marrone**

Placemat - brown  
 Nappe individuelle marron  
 Klein Tischtuch braun  
 Mantel individual marròn

**Pvc-Pet**

	Cm	In
<b>AVARITO 10</b>	<b>45x30</b>	<b>17,3/4x11,3/4</b>



**Tovaglietta - grigio scuro**

Placemat - dark grey  
Nappe individuelle gris fouché  
Klein Tischtuch dunkel grau  
Mantel individual gris oscuro

**Pvc-Pet**

	Cm	In
<b>AVARITO 01</b>	<b>45x30</b>	<b>17,3/4x11,3/4</b>



**Tovaglietta - grigio chiaro**

Placemat- light grey  
Nappe individuelle gris clair  
Klein Tischtuch hellgrau  
Mantel individual gris claro

**Pvc-Pet**

	Cm	In
<b>AVARITO 02</b>	<b>45x30</b>	<b>17,3/4x11,3/4</b>

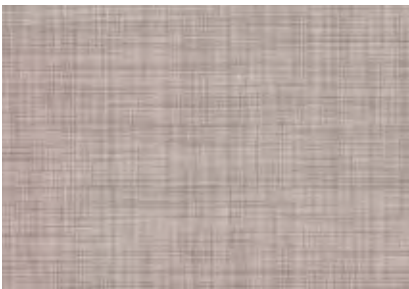

**Tovaglietta - tortora**

Placemat - taupe  
Nappe individuelle taupe  
Klein Tischtuch grau  
Mantel individual gris topo

**Pvc-Pet**

	Cm	In
<b>AVARITO 03</b>	<b>45x30</b>	<b>17,3/4x11,3/4</b>



**Tovaglietta - beige/azzurro**

Placemat - beige/blue  
Nappe individuelle beige/bleue  
Klein Tischtuch beige/hellblau  
Mantel individual beige/azul claro

**Pvc-Pet**

	Cm	In
<b>AVARITO 05</b>	<b>45x30</b>	<b>17,3/4x11,3/4</b>

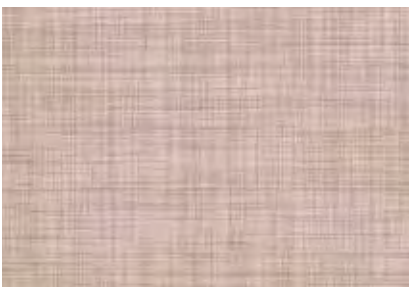

**Tovaglietta - sabbia**

Placemat - sand  
Nappe individuelle sable  
Klein Tischtuch sand  
Mantel individual arena

**Pvc-Pet**

	Cm	In
<b>AVARITO 07</b>	<b>45x30</b>	<b>17,3/4x11,3/4</b>



**Tovaglietta - marrone lavorato**

Placemat - light brown - woven  
Nappe individuelle marron tressée  
Klein Tischtuch braun, gearbeitet  
Mantel individual marrón tejido

**Pvc-Pet**

	Cm	In
<b>AVARITO 08</b>	<b>45x30</b>	<b>17,3/4x11,3/4</b>

**Bivalva Roberta**

Roberta blister, Italy

Blister Roberta Italy

Sichtbare Blase (ohne Bestecke)

Blister Roberta Italy

**Acciaio inox 18|10 / 18|10 St. Steel**

Cucchiaio tavola	F85 22 401	pcs 24
Forchetta tavola	F85 22 402	pcs 24
Coltello tavola	F85 21 205	pcs 12
Cucchiaino caffè	F85 24 821	pcs 48
Forchetta dolce	F85 23 638	pcs 36





**Bivalva Corsaro**

Corsaro blister, Italy  
Blister Corsaro Italy  
Sichtbare Blase (ohne Bestecke)  
Blister Corsaro Italy

**Acciaio inox 18|10 / 18|10 St. Steel**

Set 24 pezzi    LV1 BI 240F    pcs 24



**Rist & Bar Corsaro**

Corsaro , Rist &amp; Bar

Rist &amp; Bar Corsaro

Rist &amp; Bar Corsaro

Rist &amp; Bar Corsaro

**Acciaio inox / St. Steel**

Cucchiaio tavola Corsaro in GN 1/4	LV1 14B 6601	pcs 66
Forchetta tavola Corsaro in GN 1/4	LV1 14B 9602	pcs 96
Coltello tavola Corsaro in GN 1/4	LV1 14B 4805	pcs 48
Cucchiaino caffè Corsaro in GN 1/6	LV1 16B AT21	pcs 120
Cucchiaino caffè Corsaro in GN 1/9	LV1 19B BL22	pcs 150
Forchettina dolce Corsaro in GN 1/6	LV1 16B 9638	pcs 96



## BARattoli

BARattoli  
 BARattoli  
 BARattoli  
 BARattoli

### Acciaio inox / St. Steel

Cucchiaini Moka	LV1 14B 6601	pcs 150
Cucchiaini Caffè	LV1 14B 9602	pcs 120
Palette Moka	LV1 14B 4805	pcs 180



**Blister coltelli carne Rost punta**

Rost steak knives blister  
Blister de couteaux à viande Rost  
Fleischmesser Rost Blisterpackung  
Blister cuchillos carne Rost

AVARI 064B 06 pcs 6  
AVARI 064B 12 pcs 12

**Blister coltelli carne Rost punta tonda**

Rost steak knives round point blister  
Blister de couteaux à viande Rost pointe ronde  
Fleischmesser Rost Blisterpackung  
Blister cuchillos carne Rost

AVARI 064T B06 pcs 6  
AVARI 064T B12 pcs 12

**Blister coltelli pizza Rost**

Pizza knives Rost blister  
Blister de couteaux à pizza Rost  
Rost Pizzamesser Blisterpackung  
Blister cuchillos pizza Rost

AVARI 064P B06 pcs 6  
AVARI 064P B12 pcs 12



## Blister coltelli spelucchino Rost

Rost paring knives blister  
Blister de couteau à éplucher Rost  
Schälmesser Rost Blisterpackung  
Blister Cuchillo guarnecer Rost

AVARI 064S B12 pcs 12



## Blister pz.6 coltelli carne Arlecchino

Arlecchino steak knives 6-pc blister  
Blister 6 pcs de couteaux à viande Arlecchino  
6-teiliges Fleischmesser Arlecchino Blisterpackung  
Blister 6 pzas cuchillos carne Arlecchino

### Acciaio inox colori assortiti

	mm	In
● AVARI 047 47	211	8,1/4
● AVARI 047 07	211	8,1/4
○ AVARI 047 13	211	8,1/4
● AVARI 047 34	211	8,1/4
● AVARI 047 06	211	8,1/4
○ AVARI 047 19	211	8,1/4
● AVARI 047 14	211	8,1/4



## Blister pz.6 coltelli carne Arlecchino punta tonda

Arlecchino steak knives round-point 6-pc blister  
Blister 6 pcs de couteaux à viande Arlecchino pointe ronde  
6-teiliges Fleischmesser Arlecchino Blisterpackung  
Blister 6 pzas cuchillos carne Arlecchino con punta redonda

### Acciaio inox colori assortiti

	mm	In
● AVARI 047T 47	211	8,1/4
● AVARI 047T 07	211	8,1/4
○ AVARI 047T 13	211	8,1/4
● AVARI 047T 34	211	8,1/4
● AVARI 047T 06	211	8,1/4
○ AVARI 047T 19	211	8,1/4
● AVARI 047T 14	211	8,1/4

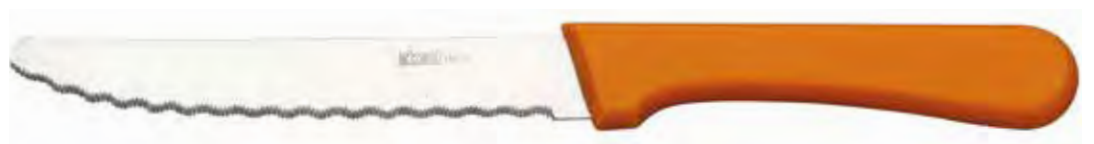



THE INTERNATIONAL CERTIFICATION NETWORK

## CERTIFICATE

SQS and IQNet Partner hereby states that the organization

**Abert S.p.A.**

**Via Don P. Mazzolari, 17 (Zona Industriale)**

**25050 Passirano (BS)**

**Italia**

for the following scope and type of activities

**Divisione Abert**

**Sito di Via Don P. Mazzolari, 17, 25050 Passirano (BS)**

**Progettazione, fabbricazione e commercializzazione di posate, complementi per la tavola, vasellame, caffettiere e pentolame.**

has implemented and maintains a

**Management System**

which fulfills the requirements of the following standard(s)

**ISO 9001:2015 / Quality Management System**

for the validity date, please refer to the original certificate\* issued by SQS

Scope No(s): 17

Issued on: 2016-11-11

Validity date: 2019-11-10

Registration Number: **CH-30537**



*Michael Drechsel*  
Michael Drechsel  
President of IQNet

*Roland Glauser*  
Roland Glauser  
CEO SQS



IQNet Partners\*\*:  
AENOR Spain AFNOR Certification France AIB Vinçotte International Belgium AFCEP Portugal CCC Cyprus  
CISQ Italy CQC China CQM China COSC China Certeo Czech Republic Cro Cert Croatia DQS Holding GmbH Germany  
PCAV Brazil FONDONORMA Venezuela ICONTEC Colombia IMC Mexico Inspecta Certification Finland INTECO Costa Rica  
IRAM Argentina IQA-India KPI Korea MITEC Greece MIST Hungary Nemko AS Norway NSAI Ireland PCBC Poland  
Quality Austria Astaris BR Russia SIGE Mexico SH Israel SIQ Slovenia SIPIM QAS International Malaysia  
SQS Switzerland SRIAC Romania TEST St Petersburg Russia TSE Turkey YUQS Serbia  
IQNet is represented in the USA by: AFNOR Certification, CISQ, DQS Holding GmbH and NSAI Inc.

\* This attestation is directly linked to the IQNet Partner's original certificate and shall not be used as a stand-alone document  
\*\* The list of IQNet partners is valid at the time of issue of this certificate. Updated information is available under [www.iqnet-certification.com](http://www.iqnet-certification.com)



## Certificato

SQS attesta che l'azienda sotto indicata dispone di un sistema di management che soddisfa le esigenze della normativa indicata.



**Via Don P. Mazzolari, 17 (Zona Industriale)**

**25050 Passirano (BS)**

**Italia**

Campo d'applicazione

**Divisione Abert**

**Sito di Via Don P. Mazzolari, 17, 25050 Passirano (BS)**

Ambito d'attività

**Progettazione, fabbricazione e commercializzazione di posate, complementi per la tavola, vasellame, caffettiere e pentolame.**

Normativa base

**ISO 9001:2015**

**Sistema di gestione per la qualità**

Scope(s) 17

Validità 11.11.2016-10.11.2019  
Versione 11.11.2016

No. di reg. 30537

*X. Edelmann*  
X. Edelmann, Presidente SQS

*R. Glauser*  
R. Glauser, CEO SQS



Associazione Svizzera per Sistemi di Qualità e di Management SQS  
Bernstrasse 103, 3052 Zollikofen, Svizzera



Partner of  
IQNet

**abert**<sup>®</sup>

**ABERT S.p.A.**

Via Don P. Mazzolari, 17  
25050 Passirano (Bs) Italy  
T. 0306853611  
F. 0306577194

[info@abert.it](mailto:info@abert.it)  
[www.abert.it](http://www.abert.it)

HO.RE.CA.

20  
19

**abert**<sup>®</sup>