

HO.RE.CA.

20

21

abert

abert

Abert nasce nel 1929 a Lumezzane, in provincia di Brescia: Antonio Bertoli dà inizio alla sua storia producendo artigianalmente posate in ottone. Negli anni '30 le materie prime utilizzate sono nichel e alluminio e nel 1950 l'acciaio entra stabilmente nei cicli di produzione, prendendo il posto di tutti gli altri materiali. Negli anni '60 verrà introdotta l'automatizzazione produttiva e nel 1975 Abert sarà la prima azienda al mondo ad ingegnerizzare i processi per la produzione di posate colorate con la combinazione di materiali come ABS, nylon e legno. Nel 1987 la sede si trasferisce a Passirano e nel 1993 acquisisce il marchio Facix e lo storico marchio milanese Broggi, leader di mercato nella posateria e nei complementi d'arredo per la tavola nel settore alberghiero. Nel 1994 è la prima azienda del settore ad ottenere la certificazione di qualità ISO 9002. Nel 2000 Abert cresce lanciando un nuovo progetto per il canale l'Ho.Re.Ca. con l'introduzione di una ampia gamma di prodotti professionali alberghieri.

Oggi, quasi novant'anni dopo la sua nascita, ancora guidata dalla famiglia Bertoli alla quarta generazione, Abert continua a puntare sull'innovazione, sulla qualità dei propri prodotti, sulla sensibilità e l'ascolto del cliente e sulla sua capacità di mutare insieme al mercato.

Abert pone da sempre al centro della propria attività valori che considera irrinunciabili: l'eccellenza delle materie prime, determinante per la performance dei propri prodotti, l'innovazione sulla base di processi produttivi e tecnologie d'avanguardia, la qualità dei prodotti che produce nei propri stabilimenti, a Passirano, il design che si traduce nella creazione di oggetti unici e che è alla base dello studio di ogni suo nuovo prodotto.

Per vincere le sfide del futuro Abert investe su se stessa e sui propri valori, che esprime con una forte cultura d'impresa ed azioni concrete, impegnandosi nella tutela e nella difesa dell'ambiente e nell'etica dei rapporti economici e sociali.

STORIA • HISTORY

Abert is founded in 1929 in Lumezzane, in the province of Brescia: Antonio Bertoli starts its story by manufacturing brass cutlery by hand. In the 30's the raw materials used are nickel and aluminium and in 1950 steel enters in the production cycles permanently, replacing all the other materials. In the '60s production automation is introduced and in 1975 Abert is the first company in the world to engineering the processes for the production of colored-handle cutlery with the combination of materials like ABS, nylon and wood. In 1987 the company headquarters move to Passirano and in 1993 Abert acquires the brand Facix and the historical Milanese brand Broggi, market leader in hotel cutlery and tableware. In 1994 it is the first company of the sector to achieve the quality certification ISO 9002. In 2000 Abert grows and launches a new project for the Ho.Re.Ca. channel with the introduction of a wide range of hotel professional products.

Today, almost ninety years after its birth, still led by the Bertoli family on its fourth generation, Abert goes on aiming at innovation, quality of its products, sensitivity and listening to its customers and on its capability of changing with the market.

Abert has always placed at the centre of its activities fundamental values: excellence of raw materials, crucial for the performance of its products, innovation on the base of production processes and state-of-the-art technologies, quality of the products it manufactures in its own factories in Passirano, design, that means creation of unique objects and which is the foundation of every new product.

In order to win the challenges of the future Abert invests on its own and on its values that expresses through a strong enterprise culture and concrete action, committing to protect and defend the environment and the ethics involved in economic and social relationships.

abert

CATALOGO HORECA 2021

POSATE / FLATWARE 5

MODERN	12
CLASSIC	48
BASIC	67
FINISHING	85
COLOR	97

ACCESSORI / ACCESSORIES 99

BASIC	101
BREAK&FAST	103
COFFEE&DRINKS	105
TAPAS&APPETIZERS	109
PIZZA&STEAKS	111
MARISCOS&ESCARGOTS	118
CHEESE	119
SERVING	120

TAVOLA / HOLLOWWARE 131

ART&TABLE	133
MENAGE	167
RICAMBI	174
LOUNGE&SERVICE	175
CELSIUS	183

WINE&BAR 189

BUFFET 205

URBAN	207
MIX&PLAY	225
SQUARE	237
JAMBEE	253
IMPERIAL	258

CARRELLI 285

GUERIDON	286
LUX	287
CARRELLI CON TOP	288
BAR/LIQUORI	290
DOLCI/FORMAGGI	291
CARRELLI MULTIUSO	292
COCKTAIL	294
ARROSTI	295
FLAMBÈ	296
MULTIUSO	297
ACCESSORI	298

PROMAB 306

MONDO CUCINA	308
CUCINA	319

Alaska	60	Condor	55	Flair	37	Matisse	40	Pop	45	Splendido	52
Alaska Inox	60	Corona	74	Garda Top	66	Med	47	Pvd	93	Step	30
Allegra	26	Corsaro	79	Gourmet	33	Milord	19	Raveil	64	Style	28
Amarcord	13	Cosmos	34	Hermitage	48	Mirage	35	Reda	50	Superior	12
America	80	Dinamica	27	Imperial	51	Monaco	39	Reda Top	50	Toronto	72
Baguette	56	Dolce vita	16	In & out	98	Murano	75	Relais	21	Toronto Inox	72
Baltic	38	Dream	17	Infinito	36	Murano Inox	75	Rem	44	Valencia	73
Baltic Abi	85	Ego	22	LInea	29	Naif	43	Rimini	71	Valencia Inox	73
Bella	41	Elegant	20	London	62	New Line	97	Rinascimento	49	Vawe/a Inox	82
Blade	84	England	61	Luisa	76	Niagara	18	River	69	Verve	63
Blade Inox	84	Enrico VIII	59	Luna	14	Oslo	77	Scotch Brite	91	Victory	58
Boston	67	Ergo	24	Malta	70	Perla	53	Scozia	65	Vintage	54
Brigitte	42	Eva	78	Mare	46	Più	31	Silvia	57	Vintage	90
Clever	25	Firenze	68	Marea	32	Polvere di luna	89	Slim	23	Wave/a	82



POSATE • CUTLERY

MODERN (12)

CLASSIC (48)

BASIC (67)

FINISHING (85)

COLOR (97)

Ciclo di produzione

Il ciclo di produzione di forchette e cucchiai inizia con l'operazione di tranciatura (1). Per diminuire lo spessore della tazza rispetto al manico, si procede poi con la laminazione (2), e si prosegue con la rifilatura (3), per dare la forma della tazza o dei rebbi alla posata laminata. Infine si passa alla coniazione (4), nel corso della quale vengono dati la forma e i decori necessari. Per la lavorazione dei coltelli monoblocco forgiati si parte con la tranciatura del tondino in uno spezzone (1), che viene successivamente coniato a caldo (2), in modo da conferirgli una prima forma. Si prosegue con la tranciatura del manico (3) e con l'allungamento della lama (4); in seguito viene effettuata la tranciatura della lama (5), in modo da darle la forma reale. A questo punto rimane da definire la seghettatura sulla lama (6) e rifinire il coltello con le normali operazioni di pulitura. Le fasi di lavorazione dei coltelli a manico cavo forgiati parte con la tranciatura delle valve (1). Le due valve che costituiranno il manico cavo vengono coniate a freddo (2), per dare loro la convessità e i decori, e poi vengono accoppiate e saldate (3): ecco il manico del coltello infine, attraverso un composto autobloccante, viene assemblata e saldata al manico la lama (4), prodotta con le stesse tecniche dei coltelli monoblocco forgiati.

Cutlery manufacturing process

Shearing (1) is the first step in the process of manufacturing forks and spoons. Rolling (2) is used to reduce the bowl thickness compared to that of the handle, and the next step is trimming (3) to give the shape of a bowl or prongs to the laminated implement. The final step is coining (4) during which the implement is shaped and ornamentation stamped. To make forged solid-handle knives the process begins by shearing a bar into a blank (1) that is then hot coined (2) so as to give it some initial shape. Afterwards the handle is sheared (3) and the blade is stretched (4). Then, the blade is sheared (5) so that it takes its final shape. Now blade serration (6) needs to be defined and the knife has to be polished as usual. The first step to make forged hollow-handle knives is shearing the shells (1). The two half-shells that will form the hollow handle are cold-coined (2) to obtain the convexity and stamp the decoration; afterwards the shells are coupled and welded (3). And that is how the knife handle is ready. Finally and by using a self-locking compound the blade, made applying the same techniques used to make forged solid-handle knives, is coupled and welded to the handle (4).

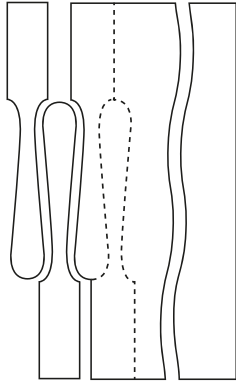

①
Tranciatura
Blank cutting

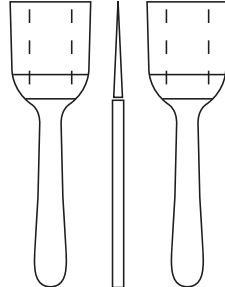

②
Laminazione
Rolling operation

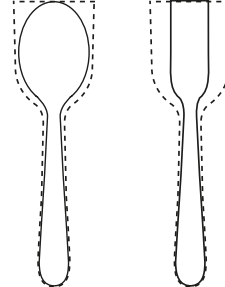

③
Rifilatura
Overall cutting on outside blank

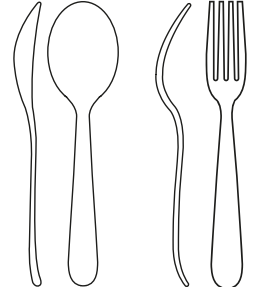

④
Coniatura
Pressing operation

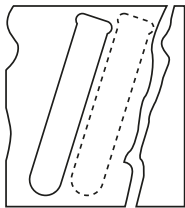

⑤
Tranciatura
Blank cutting



⑥
Coniatura manico
Handle pressing



⑦
Saldatura gocce
Soldering of shells

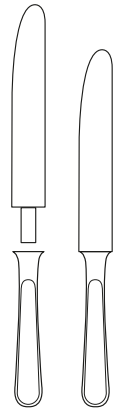

⑧
**Assemblaggio e saldatura
lama manico cavo**
Assembling and soldering
hollow handle knife



⑨
Tranciatura spezzone
Rod cutting

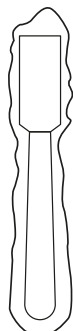

⑩
Coniatura a caldo
Forging

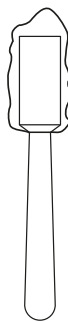

⑪
Tranciatura manico
Blank cutting of the blade

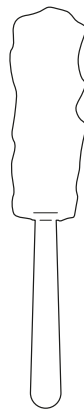

⑫
Laminazione
Rolling of the blade

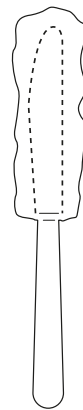



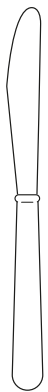



























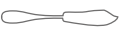











⑬
Ritanciatura lama
2nd blank cutting of the blade



⑭
Seghettatura e finitura
Blade grinding and finishing

TABELLA POSATE

01		Cucchiaino tavola Table spoon Cullière de table Eßlöffel Cuchara mesa
02		Forchetta tavola Table fork Fourchette de table Eßgabel Tenedor mesa
03		Cucchiaino brodo Bouillon spoon Cullière à soupe Suppenlöffel Cuchara sopa
04		Coltello tavola forgiato pesante Table knife heavy-forged Couteau de table forgé lourd Tafelmesser-schwer Cuchillo mesa forjado pesado *
05		Coltello tavola forgiato Table knife-forged Couteau de table forgé Tafelmesser Cuchillo mesa forjado *
05R		Coltello tavola Reverse Reverse table knife-forged Couteau de table Reverse Tafelmesser Reverse Cuchillo mesa Reverse forjado *
06		Coltello tavola leggero Table knife-light Couteau de table léger Tafelmesser-leicht Cuchillo mesa ligero *
08		Coltello tavola m/v saldato Table knife - welded hollow-handle Couteau de table poignée creuse soudée Tafelmesser mit Hohlheft Cuchillo mesa mango hueco soldado *
11		Cucchiaino frutta Dessert spoon Cuillère à dessert Dessertlöffel Cuchara postre
12		Forchetta frutta Dessert fork Fourchette à dessert Dessertgabel Tenedor postre
14		Coltello frutta forgiato pesante Dessert knife-heavy forged Couteau à dessert forgé lourd Dessertmesser-schwer Cuchillo postre forjado pesado *
15		Coltello frutta forgiato Dessert knife-forged Couteau à dessert forgé Dessertmesser Cuchillo postre forjado *
15R		Coltello frutta Reverse forgiato Dessert knife forged-Reverse Couteau à dessert Reverse forgé Dessertmesser Reverse Cuchillo postre Reverse forjado *
16		Coltello frutta leggero Dessert knife-light Couteau à dessert léger Dessertmesser-leicht Cuchillo postre ligero *
18		Coltello frutta m/v saldato Dessert knife-welded hollow-handle Couteau à dessert poignée creuse soudée Dessertmesser mit Hohlheft Cuchillo postre mango hueco soldado *
21		Cucchiaino caffè Tea spoon Cuillère à café Kaffeelöffel Cuchara café
22		Cucchiaino moka Moka spoon Cuillère à moka Mokkalöffel Cuchara moka
23		Cucchiaino zucchero Sugar spoon Cuillère à sucre Zuckerlöffel Cuchara azucar
25		Mestolo servire Soup ladle Louche Rührlöffel Cazo sopa
26		Forchettone servire Serving fork Fourchette à servir Vorlegegabel Tenedor servir
27		Cucchiaione servire Serving spoon Cuillère à servir Vorlegelöffel Cucharón servir
28		Cucchiaione insalata Salad serving spoon Cuillère à servir salade Salatlöffel Cucharón servir ensalada
29		Forchettone insalata Salad serving fork Fourchette à servir salade Salatgabel Tenedor servir ensalada
30		Cucchiaione riso Salad serving spoon Cuillère à servir salade Salatlöffel Cucharón servir ensalada
31		Forchetta pesce Fish fork Fourchette à poisson Fischgabel Tenedor pescado
32		Coltello pesce Fish knife Couteau à poisson Fischmesser Cuchillo pescado
33		Forchettone servire pesce Fish serving fork Fourchette à servir poisson Servierfischgabel Tenedor servir pescado
34		Coltello servire pesce Fish serving knife Couteau à servir poisson Servierfischmesser Cuchillo servir pescado
35		Cucchiaino bibita Ice tea spoon Cuillère à cocktail Cocktaillöffel Cuchara refresco
36		Cucchiaino fragola confetto Sweets spoon Cuillère à bonbons Bonbonlöffel Cuchara caramelos
37		Paletta gelato Ice cream spoon Cuillère à glace Speiseeislöffel Cuchara helado
38		Forchettina dolce Cake fork Fourchette à tarte Kuchengabel Tenedor lunch
39		Pala dolce Cake server Pelle à tarte Tortenschaufel Pala pastel
40		Coltellone dolce Cake knife Gros couteau à tarte Tortenmesser Cuchillo pastel
41		Coltellone torta seghettato Cake knife with serrated blade Couteau à tarte lame denteleé Kuchenmesser Cuchillo pastel dentado
42		Mestolino salsa Sauce ladle Louche à sauce Soßeschöpflöffel Cacillo salsa
43		Spalmaburro Butter spreader Couteau à beurre Buttermesser Pala mantequilla
45		Spalmaburro Butter spreader Couteau à beurre Buttermesser Pala mantequilla
53		Spalmaburro forgiato Butter spreader - forged Couteau à beurre forgé Buttermesser Pala mantequilla forjado *
55		Coltello bistecca Steak knife Couteau à bifteck Filetmesser Cuchillo carne *
63		Forchetta lumache 2 punte 2 prongs snail fork Forchette à escargots à deux dents Zweizinkengabel fur Schnecke Tenedor caracoles dos puntas
64		Forchettina ostriche Oyster fork Forchette à crustacés Auster Krustazeengabel Tenero mariscos
67		Cucchiaino salsa Sauce spoon Cuillère à sauce Soßelöffel Cuchara salsa
68		Cucchiaino bimbo Baby spoon Cuillère enfant Kinderlöffel Cuchara niño
69		Forchetta bimbo Baby fork Fourchette enfant Kindergabel Tenedor niño
70		Coltello bimbo Baby knife Couteau enfant Kindermesser Cuchillo niño *
80		Cucchiaino lunch Lunch spoon Cuillère à lunch Lunchlöffel Cuchara lunch

* materiale: acciaio inox | material: stainless steel |
matériel: acier inoxydable | Material: aus Edelstahl | material: acero inoxidable

Istruzioni d'uso e di manutenzione per la posateria e il vasellame in acciaio Inox

Lavare accuratamente i prodotti nuovi prima di utilizzarli. Utilizzare per il lavaggio acqua calda ed un buon sapone neutro, risciacquare in seguito con abbondante acqua tiepida ed asciugare scrupolosamente tutti gli articoli.

Non utilizzare per il lavaggio detersivi sintetici a base di cloro o prodotti comunque candeggianti.

Pomice, paglietta d'acciaio, spugnette o panni impregnati di polveri abrasive devono essere altresì rigorosamente esclusi. Possono invece essere utilizzati detersivi non clorurati contenente farina fossile.

E' consigliato il lavaggio degli articoli in acciaio Inox subito dopo il loro utilizzo. Qualora questo non fosse possibile è comunque importante non lasciare per più di 12 ore gli articoli sporchi a contatto con i residui alimentari (es: in caso di utilizzo degli articoli a pranzo, andrebbero lavati entro la sera del giorno stesso; in caso di utilizzo degli articoli a cena, andrebbero lavati entro la mattina del giorno seguente).

Nel caso fosse necessario un prelavaggio, questo deve essere fatto appena prima del lavaggio e per un tempo relativamente breve. Gli articoli non vanno infatti lasciati in ammollo nella soluzione lavante per troppo tempo in quanto alcune sostanze contenute negli alimenti sono dannose per l'acciaio Inox e ne alterano

l'aspetto. I coltelli e le lame dei coltelli (in caso di articolo a manico cavo) prodotte con un pregiato acciaio inox, sono sensibili agli attacchi corrosivi sviluppati dall'acido acetico, citrico, lattico ed in particolare da cloruro di sodio, presenti negli alimenti.

E' importante, sia in fase di prelavaggio che durante il lavaggio, tenere separate le normali posate (cucchiai, forchette, cucchiaini) dai coltelli e da altri oggetti metallici presenti in cucina.

Nel caso di lavaggio in lavastoviglie le posate devono essere inserite in cestelli verticali di plastica e tenute separate dai coltelli.

Asciugare accuratamente gli articoli con un panno morbido subito dopo il lavaggio, anche se il lavaggio è eseguito in lavastoviglie che prevede un ciclo di asciugatura automatica. Questo è necessario per evitare l'eventuale formazione di macchie dovute a depositi calcarei contenuti nell'acqua.

Non lasciare le posate nell'ambiente umido della lavastoviglie una volta terminato il ciclo di lavaggio, ma asciugarle e riporle in un ambiente asciutto.

Si consiglia di conservare gli articoli perfettamente asciutti, in un ambiente privo di umidità.

Per evitare rigature si consiglia di non conservare alla rinfusa gli articoli ma di riporli ordinatamente e proteggerli con un panno morbido.

instructions for use and maintenance of stainless steel cutlery and hollowware

Wash the new products carefully before use.

Use hot water to wash them and a good neutral detergent; then, rinse out with lukewarm water and dry all the items thoroughly.

When washing, do not use chlorinated detergents nor products containing bleach.

Pumice, steel wool, sponges or cloths saturated with abrasive powders must be strictly avoided. However, detergents without chloride containing fossil flour can be used.

The washing of stainless steel items after use is recommended. in case that would not be possible, it is however important not to leave for more than 12 hours the dirty items in contact with food leftovers (e.g.: if the items are used at lunch, they should be washed within the evening; if the items are used at dinner, they should be washed within the following morning).

in case a prewash was needed, it must be carried out just before the washing and for a relatively short time. in fact, the items must not be soaked in the washing solution for too long, since some substances contained in food are damaging for the stainless steel and change its appearance. Knives and knife blades (for hollow

handle items) are manufactured with a valuable stainless steel and are sensitive to the corrosion attacks developed by acetic, citric and lactic acid and in particular to sodium chloride present in food.

It is important, both when pre-washing and washing, to keep cutlery like spoons, forks and tea spoons, separated from knives and other metal kitchenware.

in case of washing in dishwasher, spoons and forks must be placed into plastic vertical baskets and kept separated from knives.

Dry the items thoroughly immediately after the washing with a soft cloth, even if your dishwasher has a dry cycle.

That is necessary in order to avoid the possible formation of stains caused by calcareous deposits contained in the water.

Do not leave the cutlery in the humid environment of the dishwasher once the washing finishes; dry them and store them in a dry place.

It is recommended to storage the items perfectly dried and in a location without humidity.

in order to avoid scratches, it is recommended not to keep the items randomly, but if it is possible, to protect them by soft cloth.













Superior

Inox 18/10 - St. Steel - 4 mm
Cod. CZ4..



COD. CZ4..

L. mm

01	
02	
03	
05	
11	
12	
15	
21	
22	
31	
32	
38	

205

206

175

235

185

186

210

137

107

180

200

143



Amarcord

Inox 18/10 - St. Steel - Forg.
Cod. CC2..









COD. CC2..		L. mm
01		214
02		214
03		193
05		235
11		193
12		193
15		212
21		150
22		113
25		305
26		247
27		247
31		185
32		206
38		148
39		251
53		176
55		230



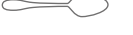

Luna

Inox 18/10 - St. Steel - 5 mm
Cod. CHP..

COD. CHP..		L. Mm
01		200
02		202
05		225
11		193
12		193
15		212
21		140
22		106
38		142

Dolce vita

Inox 18/10 - St. Steel - Forg.
Cod. CB8..



COD. CB8..

L. mm



214



214



214



235



193



193

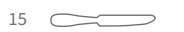

212



150



113



305



247



247



186



203



148













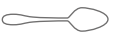

251



Dream

Inox 18/10 - St. Steel - Forg.
Cod. CF9..

COD. CF9..		L. mm
01		208
02		208
05		235
11		187
12		187
15		210
21		145
22		115
26		239
27		239
30		254
32		198
38		145
39		248













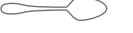

Niagara

Inox 18/10 - St. Steel - Forg.
Cod. CZ3..



COD. CZ3..

L. mm

01		210
02		203
05		231
11		181
12		183
15		210
21		142
22		113
25		306
26		237
27		234
38		160
39		250
53		175
55		228



Milord

Inox 18/10 - St. Steel - 4 mm
Cod. C14..

COD. C14..		L. mm
01		197
02		198
03		172
05		233
08		225
11		177
12		178
15		195
18		200
21		133
22		104
25		310
26		228
27		227
31		198
32		212
35		195
36		172
37		129
38		143
39		240
42		175
53		168
55		230
67		184

Elegant

Inox 18/10 - St. Steel - 4 mm
Cod. CV6..



COD. CV6..



L. mm
210



210



185



235



236



185



185



210



204

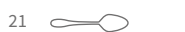

142



114



314



231



229



182



197



145



240













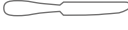
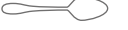





175



Relais

Inox 18/10 - St. Steel - 4 mm
Cod. CU3..

COD. CU3..		L. mm
01		210
02		212
03		185
05		235
11		187
12		192
15		212
21		135
22		112
25		305
26		240
27		240
31		185
32		197
38		143
39		247
53		176
55		230













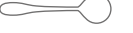



Ego

Inox 18/10 - St. Steel - 4 mm
Cod. CD3..



COD. CD3..













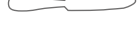



L. mm

01		207
02		207
03		182
05		231
11		186
12		186
15		209
21		145
22		114
25		306
26		237
27		234
30		278
32		215
38		150
39		250



Slim

Inox 18/10 - St. Steel - 4 mm
Cod. CU7..













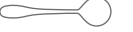
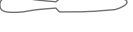



COD. CU7..	L. mm
01 	214
02 	214
03 	193
05 	235
11 	193
12 	193
15 	212
21 	150
22 	113
25 	305
26 	247
27 	247
31 	200
32 	214
38 	148
39 	251
53 	176
55 	230

Ergo

Inox 18/10 - St. Steel - 4 mm
Cod. CE5..











COD. CE5..

	L. mm
01 	207
02 	207
03 	182
05 	231
11 	186
12 	186
15 	209
21 	145
22 	114
25 	306
26 	237
27 	234
32 	215
38 	150
39 	250
53 	175
55 	228

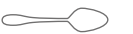

Clever

Inox 18/10 - St. Steel - 4 mm
Cod. CHG..

COD. CHG..		L. Mm
01		200
02		202
05		225
11		193
12		193
15		212
21		140
22		106
38		142

Allegra

Inox 18/10 - St. Steel- 3 mm
Cod. CM6..



COD. CM6..

L. mm



203



201



229



180



180



203



140



106



155



176

















230



Dinamica













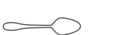

Inox 18/10 - St. Steel - 3 mm
Cod. CM7..

COD. cm7..		L. mm
01		206
02		206
05		235
11		190
12		180
15		210
21		133
22		110
25		290
26		241
27		241
31		206
32		213
38		160
39		241



Style

Inox 18/10 - St. Steel - 3 mm
Cod. CD6..

COD. CD6..		L. mm
01		202
02		202
05		230
11		182
12		182
15		208
21		140
22		108
25		310
26		232
27		233
32		201
38		146
39		246















Linea

Inox 18/10 - St. Steel - 3 mm
Cod. CF7..



COD. CF7..

L. mm

01		215
02		217
05		231
11		194
12		195,5
15		210
21		155
22		116
25		305
26		255
27		258
32		212
38		155
39		239



Step

Inox 18/10 - St. Steel - 3 mm
Cod. CF8..

COD. CF8..		L. mm
01		200
02		200
03		178
05		230
11		179
12		181
15		207
21		140
22		109,7
26		231
27		234
30		260
31		180
32		193
38		146
39		255

Più

Inox 18/10 - St. Steel - 3 mm
Cod. CD7..



COD. CD7..

L. mm

01  210

02  210

03  180

05  230

11  190

12  190

15  207

21  148

22  114

25  305

26  239

27  239

32  218

38  147

39  251















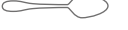



53  175

55  219



Marea

Inox 18/10 - St. Steel - 3 mm
Cod. CE4..

COD. CE4..		L. mm
01		202
02		202
03		169
05		235
11		173
12		175
15		210
21		134
22		117
25		285
26		232
27		230
32		202
35		210
38		155
39		249
53		175
55		219

Gourmet

Inox 18/10 - St. Steel - 3 mm
Cod. CF5..



COD. CF5..

L. mm



195



198



227



195



177



202

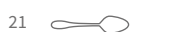

131

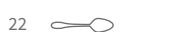

103



153

















219



Cosmos

Inox 18/10 - St. Steel - 2,5 mm
Cod. C06..

COD. C06..		L. mm
01		197
02		199
05		213
11		177
12		179
15		200
21		130
22		108
25		305
26		230
27		225
35		197
38		150
42		178

Mirage

Inox 18/10 - St. Steel - 2,5 mm
Cod. C17..



COD. C17..

01  197

02  200

05  213

06  223

11  178

12  179

15  199

21  135

22  110

25  314

26  230

27  229

31  203

32  222

35  210

38  159

39  247

55  210

L. mm











Infinito

Inox 18/10 - St. Steel- 2,5 mm
Cod. CV7..

COD. CV7..

L. mm

01		207
02		207
05		231
11		186
12		186
15		209
21		145
22		114
38		150

Flair

Inox 18/10 - St. Steel - 2,5 mm
Cod. C02..



COD. C02..



197



200



213



178



179



199



135



110



314



230



229



203



222



159



247



175



220



Baltic

Inox 18/10 - St. Steel - 2,5 mm
Cod. CB6..

COD. CB6..		L. mm
01		195
02		195
05		216
06		215
11		181
12		176
15		192
21		134
22		105
25		307
26		233
27		232
28		223
29		221
32		208
35		209
38		140
39		244
63		158
COD. CB6KO..		L. mm
68		151
69		151
70		166











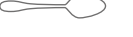

Monaco

Inox 18/10 - St. Steel - 2,5 mm
Cod. C34..



COD. C34..

L. mm

01		196
02		195
05		211
11		170
12		173
15		190
21		131
22		110
27		223
31		195
32		205
38		155
39		238
42		158



Matisse

Inox 18/10 - St. Steel - 2,5 mm
Cod. CF1..

COD. CF1..		L. mm
01		204
02		205
03		168
05		230
11		178
12		178
15		208
21		137
22		110
25		295
26		240
27		237
31		203
32		210
35		207
37		133
38		153
39		238
42		170
53		178
55		230
63		156
64		156
80		158

Bella

Inox 18/10 - St. Steel - 2,2 mm
Cod. CE3..



COD. CE3..



L. mm
204



204



175



230



183



183



207

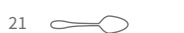

143

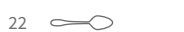

112



270



236



236













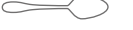



143



Brigitte

Inox 18/10 - St. Steel - 2 mm
Cod. C68..

COD. C68..		L. mm
01		195
02		197
06		213
11		178
12		177
16		190
21		131
22		103
25		315
26		230
27		226
31		190
32		210
38		153
39		240





Naif

Inox 18/10 - St. Steel - 1,8 mm
Cod. CE8..



COD. CE8..

L. mm

01		200
02		202
05		220
21		136
38		155



Rem

Inox 18/10 - St. Steel - 1,8 mm
Cod. C89..

COD. C89..		L. mm
01		201
02		200
05		223
15		197
21		141
22		111
25		285
26		234
27		235
35		208
38		141
39		226
80		161









Pop

Inox 18/10 - St. Steel - 1,8 mm
Cod. CD4..



COD. CD4..











L. mm

01		201
02		200
05		212
06		210
21		141
22		111
35		208
38		141



Mare

Acciaio Inox - St. Steel - 3 mm
Cod. CN8..

COD. CN8..		L. mm
01		202
02		202
05		222
11		173
12		175
15		191
21		134
22		117
38		155
53		175
80		144

Med

Acciaio Inox - St. Steel - 2,2 mm
Cod. CT1..



COD. CT1..



204



205



230



137



110

Hermitage

Inox 18/10 - St. Steel - 5 mm
Cod. C09..



COD. C09..

L. mm



202



201



178



228



182



181



205

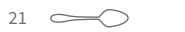

142

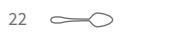

107



312



262



258



200



215



146



252



180













175























Rinascimento

Inox 18/10 - St. Steel - 3 mm
Cod. CHA..

COD. CHA..		L. mm
01		198
02		200
03		170
05		235
11		176
12		179
15		210
21		133
22		107
38		154

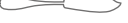







Rada

Inox 18/10 - St. Steel - 3 mm
Cod. C29..

COD. C29..	L. mm
01 	208
02 	206
03 	175
04 	236
05 	230
11 	187
12 	187
14 	216
15 	210
21 	142
22 	141
25 	300
26 	227
27 	225
31 	182
32 	201
35 	139
37 	152
38 	142
39 	240
55 	220

Rada Top

Inox 18/10 - St. Steel - 4 mm
Cod. C29T..

COD. C29T..	L. mm
01 	206
02 	207
04 	236
11 	187
12 	188
14 	216
21 	140
22 	110
38 	150



Imperial

Inox 18/10 - St. Steel - 3 mm
Cod. C04..



COD. C04..		L. mm
01		207
02		208
03		174
05		239
08		247
11		187
12		188
15		216
18		214
21		141
22		111
23		116
25		315
26		239
27		239
28		206
29		205
31		186
32		210
33		242
34		260
35		192
36		174
37		133
38		145
39		240
40		255
42		164
53		170
55		220
67		188



















Splendido

Inox 18/10 - St. Steel - 3,5 mm
Cod. C19..



COD. C19..

L. mm

01		201
02		200
03		178
05		218
11		180
12		180
15		201
21		140
22		106
25		303
26		230
27		229
31		200
32		214
38		148
39		242
42		179
43		170



Perla

Inox 18/10 - St. Steel - 3 mm
Cod. CZ1..

COD. CZ1..		L. mm
01		200
02		201
03		176
05		235
11		180
12		180
15		204
21		140
22		104
31		197
32		208
38		152

Vintage

Inox 18/10 - St. Steel - 3 mm
Cod. CB5..



COD. CB5..



L. mm
208



206



229



187



187



206

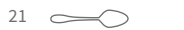

142

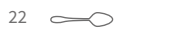

117



300



227



225



181



202

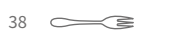

152



242



237













203



Condor

Inox 18/10 - St. Steel - 2,5 mm
Cod. C18..

COD. C18..		L. mm
01		196
02		194
05		212
11		170
12		173
15		197
21		130
22		110
26		227
27		223
38		155

Baguette

Inox 18/10 - St. Steel - 2,5 mm
Cod. CP1..

COD. CP1..

L. mm



205



205



169



246



225



179



179



195



200

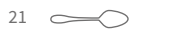

143

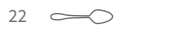

110



295



239



236



205



211



207

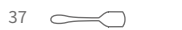

133



154



238



172

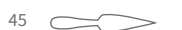

178



175



212





















179

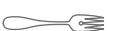



Silvia













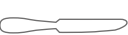
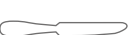









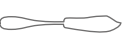

Inox 18/10 - St. Steel - 2,5 mm
Cod. CP7..

COD. CP7..		L. mm
01		207
02		206
05		226
11		179
12		179
15		212
21		139
22		112
25		292
26		227
27		227
31		181
32		205
33		221
34		241
38		150
39		268
42		183

Victory

Inox 18/10 - St. Steel - 2,5 mm
Cod. CP2..

COD. CP2..











		L. mm
01		203
02		204
03		167
05		221
06		214
08		247
11		178
12		179
15		208
16		191
18		214
21		137
22		110
25		299
26		239
27		236
31		203
32		210
35		206
37		132
38		153
39		235
42		170
45L		177
53		170
55		227
80		160

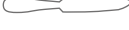























Enrico VIII

Inox 18/10 - St. Steel - 2,5 mm
Cod. CUB..

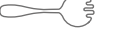
COD. CUB..		L. mm
01		205
02		204
03		168
05		220
11		186
12		184
15		200
21		137
22		121
31		182
32		193
38		142









Alaska

Inox 18/10 - St. Steel - 2,2 mm
Cod. C24..

COD. C24..	L. mm
01 	195
02 	195
05 	209
06 	212
11 	175
12 	176
15 	190
16 	190
21 	137
22 	103
25 	314
26 	223
27 	223
28 	207
29 	206
35 	208
37 	134
38 	152
39 	224
40 	223
42 	175

Alaska Inox

Inox 18/CR - St. Steel - 1,8 mm
Cod. CG3..

COD. CG3..	L. mm
01 	195
02 	195
*06 	212
21 	128
22 	117
35 	208
37 	134
38 	175

*C2406L













England

Inox 18/10 - St. Steel - 2,2 mm
Cod. C97RO..



COD. C97RO..

L. mm

01		203
02		201
05		229
11		180
12		180
15		203
21		140
22		106
38		144
39		245

London

Inox 18/10 - St. Steel - 2,2 mm
Cod. CP3..



COD. CP3..

L. mm



203



204



220



177



177



209



137



110



304



237



237



152



234



237









177

Verve

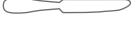
Inox 18/10 - St. Steel - 1,8 mm
Cod. C37..

**COD. C37..****L. mm**

01		199
02		200
03		166
06		212
21		140
22		105
38		145

Reveil

Inox 18/10 - St. Steel - 1,8 mm
Cod. C30..



COD. C30..

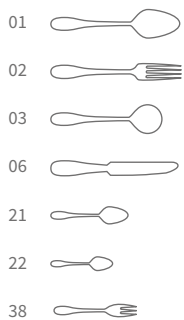









L. mm

200
200
170
212
140
105
145

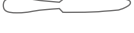

Scozia

Inox 18/CR - St. Steel - 3,0 mm
Cod. CN6..

COD. CN6..		L. mm
01		200
02		200
05		218
11		180
12		180
15		203
21		138
22		105
38		143











Garda Top

Inox 18/10 - St. Steel - 4 mm
Cod. C82T..



COD. C82T..

L. mm

01		210
02		210
05		235
11		184
12		184
15		212
21		140
22		110
32		220
38		150













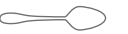





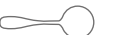

Boston

Inox 18/10 - St. Steel - 2,5 mm
 Manico satinato - Mat finishing handle
 Cod. C39..



COD. C39..

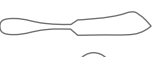







L. mm

01		195
02		196
05		213
11		173
12		177
15		192
21		132
22		116
25		308
26		225
27		222
28		203
29		205
31		190
32		204
35		206
37		131
38		153
39		240
40		259
42		185



Firenze

Inox 18/10 - St. Steel - 2,5 mm
Cod. C84..

COD. C84..		L. mm
01		195
02		196
05		208
11		173
12		175
15		194
21		132
22		116
38		152

River

Inox 18/10 - St. Steel - 2,2 mm
Cod. CV9..



COD. CV9..



195



194



229



172



174



191

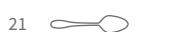

129

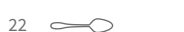

111

















153



Malta

Inox 18/10 - St. Steel - 1,8 mm
Cod. C60..









COD. C60..		L. mm
01		194
02		193
05		215
11		174
12		175
15		194
21		122
22		102
25		298
26		224
27		222
38		141
39		244
42		167

Rimini

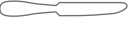
Inox 18/10 - St. Steel - 2 mm
 Manico satinato - Mat finishing handle
 Cod. C45..











COD. C45..

		L. mm
01		195
02		194
05		229
11		172
12		174
15		191
21		129
22		111
38		153

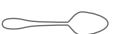









Toronto

Inox 18/10 - - St. Steel - 2,0 mm
Cod. CH8..

COD. CH8..		L. mm
01		195
02		196
05		213
11		173
12		177
15		192
21		132
22		116
38		153

Toronto Inox

Inox 18/CR - St. Steel - 1,8 mm
Cod. CG8..



















COD. CG8..		L. mm
01		195
02		196
* 05		213
21		132
22		116
35		206
37		131
38		153

Valencia

Inox 18/10 - St. Steel - 1,8 mm
Cod. CR9..

COD. CR9..

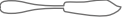
L. mm

01		195
02		198
03		169
05		224
06		215
11		177
12		179
15		209
16		192
21		138
22		110
25		298
26		240
27		236
31		198
32		201
35		207
37		135
38		154











Valencia Inox

Inox 18/CR - St. Steel - 1,8 mm
Cod. CG2..

COD. CG2..

L. mm









01		195
02		198
*06		215
21		138
22		110
35		207
37		135
38		154

*CR906

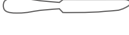
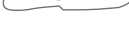
Corona







Inox 18/10 - St. Steel - 1,8 mm
Cod. CS0..



COD. CS0..		L. mm
01		195
02		198
03		169
05		221
06		215
11		177
12		179
15		207
21		138
22		110
38		154







Murano

Inox 18/10 - St. Steel - 1,8 mm
Cod. CD5..

COD. CD5..		L. mm
01		199
02		201
06		211
21		140
22		105
38		145

Murano Inox

Inox 18/CR - St. Steel- 1,8 mm
Cod. CG5..

COD. CG5..		L. mm
01		199
02		201
* 06		211
21		140
22		105
35		187
38		145











*CD506

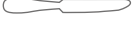



Luisa

Inox 18/10 - St. Steel - 1,8 mm
Cod. CS4..

COD. CS4..		L. mm
01		193
02		196
06		212
11		179
12		180
16		190
21		130
22		124
35		187
37		134
38		145

Oslo

Inox 18/CR - St. Steel - 2 mm
 Manico satinato - Mat finishing handle
 cod. C49..



COD. C49..

L. mm



192



192



210



174



177



190



127



113



283



233



226











151



Eva

Inox 18/CR - St. Steel - 1,5 mm
Cod. CT4E..

COD. CT4E..		L. mm
01		194
02		193
06		209
21		129
22		110
35		207
37		134
38		154

Corsaro

Inox 18/CR - St. Steel - 1,5 mm
Cod. CV1..



COD. CV1..

L. mm



195



195



212



130



103

















159



America

Inox 18/CR - St. Steel - 1,5 mm
Cod. C46..







COD. C46..	L. mm
01 	193
02 	193
05 	210
06 	212
11 	173
12 	170
15 	190
16 	190
21 	120
22 	102
26 	222
27 	221
38 	141
55 	215











Wave/A

Inox 18/10 - St. Steel - 1,8 mm
Cod. CHF..

COD. CHF..		L. mm
01		200
02		202
06		220
21		140
22		106
38		142

Wave/A Inox

Inox 18/CR - St. Steel - 1,8 mm
Cod. CHD..







COD. CHD..		L. mm
01		200
02		202
06		220
21		140
22		106
38		142











Blade

Inox 18/10 - St. Steel - 1,8 mm
Cod. CHM..

COD. CHM..		L. mm
01		200
03		201
06		220
21		141
22		105
38		141

Blade Inox

Inox 18/CR - St. Steel - 1,8 mm
Cod. CHL..

COD. CHL..		L. mm
01		200
03		201
06		220
21		141
22		105
38		141

Baltic Abi

Inox 18/10 - St. Steel - 2,5 mm
Cod. CB6S..



COD. CB6S..

L. mm



195



195



216



134

Personalizzazioni laser

Laser customization
 Personnalisation laser
 Laserpersonalisierung
 Personalización láser

**Punzonatura Laser**

Laser punching
 Poinçonnage laser
 Laser-Lochen
 Punzonado laser

**Punzonatura Meccanica**

Mechanical punching
 Poinçonnage mécanique
 Mechanish-Lochen
 Punzonado mecánico

Ordini minimi 6.000 pezzi per articolo
6.000 pcs/item minimum orders
Commandes minimales de 6.000 pcs par article
Bestellungen von 6.000/Stücke mindestens
Pedidos mínimos de 6.000 pzs por artículo

**Punzonatura Pantografo**

Pantograph punching
 Poinçonnage par pantographe
 Gravierung
 Punzonado con pantògrafo

**Doratura**

Gold-plating
 Dorure
 Vergoldung
 Dorado





Finiture di tendenza e nuances raffinate che suscitano nuove sensazioni, trasmettono stile e personalizzano la mise en place.

Trendy finishes and refined nuances that arouse new sensations, convey style and personalise the mise-en-place.

Finitions de tendance et nuances raffinées qui donnent des sensations nouvelles, en transmettant style et en personnalisant la mise en place des tables.

Acabados de tendencia y tonos refinados que provocan nuevas sensaciones, transmiten estilo y personalizan la mise en place.

Trendige Oberflächen und raffinierte Nuancen, die neue Empfindungen wecken, Stil vermitteln und das Mise en Place personalisieren.

FINITURE SPECIALI • SPECIAL FINISH

Vintage

L'opacità, i graffi ed i segni volutamente prodotti sulla superficie delle posate con finitura Vintage danno la sensazione di oggetti vissuti ed utilizzati a lungo, di grandi cucine profumate, calde e piene di vapore, di convivialità di altri tempi, di sapori antichi. Evocano immagini di ambienti tradizionali, rustici e senza pretese di modernità.

Opacity, scratches and marks intentionally made on the surface of the cutlery with a Vintage finish give the effect of objects that have been used for a long time, of a large, warm and steamy kitchen filled with aromas, of the friendly gatherings of old good times and ancient flavours. They evoke images of traditional, simple environments with no intention to be modern.

L'opacité, les égratignures et les marques intentionnellement produites sur la surface des couverts à finition Vintage donnent le sentiment d'objets vécus et utilisés depuis longtemps, de grandes cuisines odorantes, chaudes et pleines de vapeur, de convivialité d'autrefois, de saveurs d'antan. Elles évoquent des images de lieux traditionnels, rustiques et sans prétention de modernité.

La opacidad, los rasguños y las marcas producidos deliberadamente en la superficie de los cubiertos con acabado Vintage dan la sensación de objetos vividos y utilizados por largo tiempo, de grandes cocinas perfumadas, cálidas y llenas de vapor, de convivialidad de otros tiempos, de sabores antiguos. Evocando imágenes de ambientes tradicionales, rústicos y sin pretensiones de modernidad.

Der Mattglanz, die "Kratzer" und gezielt in die Oberfläche eingearbeiteten Zeichen der Serie 'Vintage' verleihen diesem Besteck einen besonders raffinierten Look von seit langem benutzten Gegenständen, erinnern an die Atmosphäre großer gemütlicher Wohnküchen von früher, wo es herrlich nach den Gerichten unserer Kindheit duftete. Sie rufen Bilder traditioneller Ambiente wach, ohne dem Anspruch moderner Stilformen nachzugeben.

Polvere di Luna

La finitura Polvere di Luna rende l'aspetto delle posate satinato e delicatamente brillante: una superficie levigata con chiaroscuri. Piacevoli e vellutate al tatto, trasmettono una morbidezza ed un calore inconsueto per oggetti di acciaio. Un rivestimento sobrio ed inusuale per posate contemporanee.

The Polvere di Luna finish makes cutlery surface look satin-like and delicately brilliant: a smooth surface with contrasting shades. Pleasant and velvety to the touch, the cutlery so treated convey a softness and warmth unusual for steel objects. A sober and unusual coating for contemporary cutlery.

La finition Polvere di Luna rend l'aspect des couverts satiné et délicatement brillant : une surface polie avec des clairs-obscur. Agréables et veloutées au toucher, ils transmettent une douceur et une chaleur insolites pour des objets en acier. Un revêtement sobre et inusuel pour des couverts contemporains.

El acabado Polvere di Luna confiere a los cubiertos un aspecto satinado y delicadamente brillante: una superficie pulida con claroscuros. Agradables y aterciopelados al tacto, transmiten una suavidad y una calidez insólitas en objetos de acero. Un revestimiento sobrio e inusual para cubiertos contemporáneos.

Die Oberflächenbearbeitung 'Polvere di Luna' verleiht dem Besteck samt dem Glanz mit edlen hell-dunkel Schattierungen. Von ausgesprochen gepflegter Haptik, liegt dieses Besteck weich und besonders angenehm in der Hand und strahlt eine für Stahl ungewöhnliche Wärme aus. Ein dezentes und einzigartiges Oberflächenfinish für zeitgenössisches Besteck.

Scotch-Brite

Questo effetto superficiale, tipicamente utilizzato nell'architettura di interni, è caratterizzato dalla presenza di molteplici e lievissime graffiature longitudinali; dona al metallo una sembianza velata e luminosa al tempo stesso, conferendo agli oggetti che riveste un aspetto di brillantezza pacata, di acciaio non lucente. Per utensili che evocano il design di stile nordico.

This superficial effect, typically used in the interior architecture, is characterized by the presence of numerous and very light longitudinal scratches; it adds to the metal a veiled and bright appearance at the same time, bestowing to the objects it covers an aspect of measured brilliance, of non-glowing steel. For tools that evoke northern design.

Cet effet de surface, typiquement utilisé dans l'architecture d'intérieur, se caractérise par la présence de plusieurs et très légères éraflures longitudinales; cela rend le métal d'une apparence voilée et lumineuse en même temps, en donnant aux objets un aspect d'éclat paisible, d'acier pas brillant. Pour outils qui évoquent le design du style nordique.

Este efecto superficial, típicamente utilizado en la arquitectura de interiores, se caracteriza por la presencia de múltiples rasguños longitudinales; proporciona al metal una apariencia velada y luminosa al mismo tiempo, otorgando a los objetos que cubre un aspecto de brillo sosegado, de acero no reluciente. Para utensilios que evocan diseño de estilo nórdico.

Dieser Oberflächeneffekt, der typischerweise in der Innenarchitektur verwendet wird, charakterisiert sich für das Vorhandensein mehrerer und sehr geringer Längskratzer. Es verleiht dem Metall gleichzeitig einen verschleihten und leuchtenden Anschein und verleiht den Objekten, die es abdeckt, einen Aspekt ruhiger Brillanz und nicht glänzenden Stahls. Scotch-brite ist ideal für Werkzeuge, die an das nordische Design erinnern.

Polvere di Luna

Moon Dust
Cod. ...32



Finitura disponibile per tutti i modelli

Finish available for all models

Non disponibile per posate a manico cavo

Not available for hollow-handle cutlery

Minimo di ordine 500 pz assortiti

500 assorted pcs minimum order



Vintage

Vintage
Cod. ...51

Finitura disponibile per tutti i modelli

Finish available for all models

Non disponibile per posate a manico cavo

Not available for hollow-handle cutlery

Minimo di ordine 500 pz assortiti

500 assorted pcs minimum order

Scotch-Brite

Inox Scotch Brite
Cod. ...73



Finitura disponibile per tutti i modelli

Finish available for all models

Non disponibile per posate in PVD

Not available in PVD cutlery

Minimo di ordine 500 pz assortiti

500 assorted pcs minimum order

PVD

The PVD (Physical Vapour Deposition) technique allows to deposit a high-thickness metal film with remarkable characteristics from the decorative and technical point of view. Such process makes the product treated durable in time and gives high surface hardness. The item turns resistant to solvents, acids and to various products used in the kitchen, keeping its chemical/physical characteristics unchanged. It is a thoroughly biocompatible, anallergic treatment and suitable for food contact.

La technique PVD (Physical Vapour Deposition) permet de déposer un film métallique de haute épaisseur avec des caractéristiques surprenantes du point de vue décoratif et technique. Ce processus rend le produit traité durable et confère une dureté superficielle élevée. L'article devient résistant aux solvants, aux acides et aux différents produits employés en cuisine, gardant intactes ses propres caractéristiques chimio/physiques. C'est un traitement absolument biocompatible, anallergique et approprié au contact avec la nourriture.

La técnica PVD (Physical Vapour Deposition) permite depositar una película metálica de alto grosor con características sorprendentes desde el punto de vista decorativo y técnico. Este procedimiento hace que el producto tratado sea duradero en el tiempo y le

confiere una elevada dureza superficial. El artículo se torna resistente a los solventes, a los ácidos y a los diversos productos empleados en la cocina, manteniendo intactas sus características químico/físicas. Es un tratamiento absolutamente biocompatible, antialérgico y apto para el contacto con los alimentos.

Die PVD Technik ermöglicht die Beschichtung mit einem dickwandigen Metallfilm von überraschenden dekorativen und technischen Merkmalen. Das Verfahren verleiht dem Produkt längere Lebensdauer und eine ausgeprägte Oberflächenhärte, macht beständig gegen Lösungsmittel, Säuren und verschiedene Haushaltsmittel, wobei die chemischen und physischen Eigenschaften des Produkts selbst intakt bleiben. Die Behandlung ist absolut bioverträglich, allergenfrei und lebensmitteltauglich.

La tecnica PVD (Physical Vapour Deposition) permette di depositare un film metallico di alto spessore con caratteristiche sorprendenti dal punto di vista decorativo e tecnico. Questo procedimento rende il prodotto trattato durevole nel tempo e conferisce elevata durezza superficiale. L'articolo diventa resistente ai solventi, agli acidi e a vari prodotti usati in cucina, mantenendo intatte le proprie caratteristiche chimico/fisiche. E' un trattamento assolutamente biocompatibile, anallergico ed idoneo al contatto con il cibo.



PVD

PVD

Cod. ...41 Oro - Gold

Cod. ...40 Rame - Copper

Cod. ...42 Nero - Black

Cod. ...85 Bronzo - Bronze



Finitura disponibile per tutti i modelli

Finish available for all models

Non disponibile per posate a manico cavo

Not available for hollow-handle cutlery

Minimo di ordine 500 pz assortiti

500 assorted pcs minimum order

PVD Oro

PVD Gold

Cod. ...41



PVD Rame

PVD Copper

Cod. ...40



PVD Nero

PVD Black

Cod. ...42



PVD Bronzo

PVD Bronze

Cod. ...85



Polvere di Luna PVD Oro

Moon Dust PVD Gold

Cod. ...35

**Polvere di Luna PVD Rame**

Moon Dust PVD Copper

Cod. ...53

**Polvere di Luna PVD Nero**

Moon Dust PVD Black

Cod. ...39

**Polvere di Luna PVD Bronzo**

Moon Dust PVD Bronze

Cod. ...83



Vintage PVD Oro

Vintage PVD Gold

Cod. ...57



Vintage PVD Rame

Vintage PVD Copper

Cod. ...56



Vintage PVD Nero

Vintage PVD Black

Cod. ...75



Vintage PVD Bronzo

Vintage PVD Bronze

Cod. ...84







New Line

Inox 18/10 / ABS - St. Steel / ABS - 2 mm
Cod. PV9..

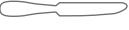

COD. PV9..

L. mm

01		200
02		205
05		215
21		142
55		216



07



13



14



19



24



47







in & Out

Nylon / PP
Cod. PV8..

in & Out è la nuova linea di posate in nylon vetrificato versatile, informale e colorata che Abert propone per essere utilizzata con creatività, in casa come in giardino, al ristorante o a bordo piscina, al bar o in barca. Date sfogo alla fantasia con le posate in & Out e usatele quando e dove volete e con serenità: sono solide e resistenti, interamente prodotte in Italia, riutilizzabili e lavabili in lavastoviglie.

in & Out is the new glossy-glazed-nylon cutlery, versatile, informal and lively that Abert offers to be used with creativity at home and in the garden, at the restaurant or at the pool side, at the bar or in the boat. Let your imagination run wild with in & Out cutlery and use it when and where you wish and don't be afraid: it is robust and resistant, entirely made in Italy, reusable and washable in dishwasher.

COD. PV8..		L. mm
01		203
02		201
05		218
21		132

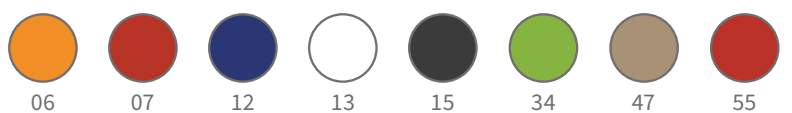





ACCESSORI • ACCESSORIES



Bacchette sushi Ergo

Ergo sushi chopsticks
 Baguettes à sushi Ergo
 Ergo Sushi stäbchen
 Palillos para sushi Ergo

Inox 18/10 - St. Steel

	Mm	In
903 05 84 660 X	230	9
Set 2 pz - 2-pc set		
903 05 84 660 K1		
Cartella - Card		

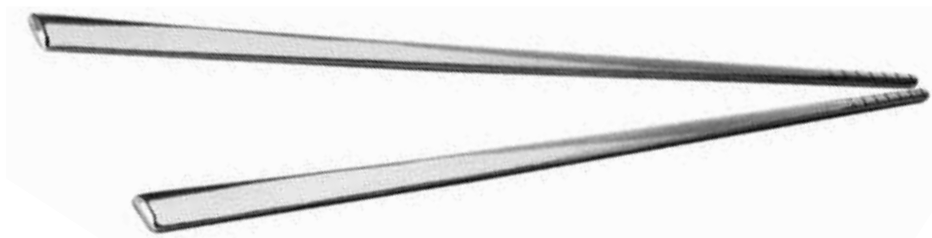
**Poggiabastoncini Ergo**

Ergo Cutlery stand
 Porte - couverts Ergo
 Ergo Besteck Bänke
 Posa cubiertos Ergo

Inox 18/10 - St. Steel

	Mm	In
903 05 84 662	60	2,3/8

**Bacchette sushi Lapis**

Lapis sushi chopsticks
 Baguettes à sushi Lapis
 Lapis Sushi stäbchen
 Palillos para sushi Lapis

Inox/Abs - St. Steel/Abs

	Mm	In
TLA 154 02 82	230	9
Set 2 pz - 2-pc set		

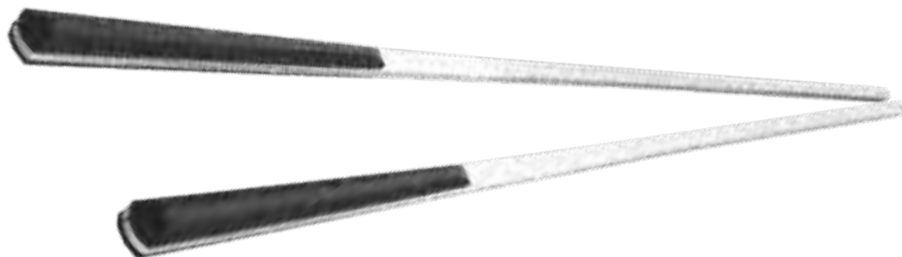
**Poggiabastoncini ABS**

ABS cutlery stand
 Porte - couverts ABS
 ABS Besteck Bänke
 Posa cubiertos ABS

Abs

		Mm	In
118 12 00 081	Trasp.	50x28x12	2x1,1/8x3/8
118 12 00 082	Nero	50x28x12	2x1,1/8x3/8



Legatovaglioli / poggiabastoncini Bamboo

Bamboo napkin ring / cutlery stand
 Rond de serviettes / porte - couverts Bamboo
 Serviettenhalter / posa cubiertos, Bamboo
 Servilletero / besteck bänke Bamboo

Inox 18/10 - St. Steel

	Mm	H Mm	In	H In
V01 05 81 005	60x35	40	2.3/8x1,3/8	1,1/2

Disegnato da Tianshu Shi e Mengdi Xu



Poggiaposate rotondo

Round cutlery stand
 Porte-couverts rond
 Bestek bänke rund
 Posa cubiertos redondo

Inox 18/10 - St. Steel

	ø Cm	ø In
903 05 84 670	10	3,9



Legatovaglioli tondo

Round napkin ring
 Rond de serviette
 Serviettenhalter
 Servilletero redondo

Inox 18/10 - St. Steel

	ø Mm	ø In
V01 05 81 001	40	1,2/3



Poggiabastoncini Branch

Branch cutlery stand
 Porte - couverts Branch
 Branch Besteck Bänke
 Posa cubiertos Branch

Inox 18/10 - St. Steel

	Mm	In
118 05 00 081	30x74	1,1/8x3

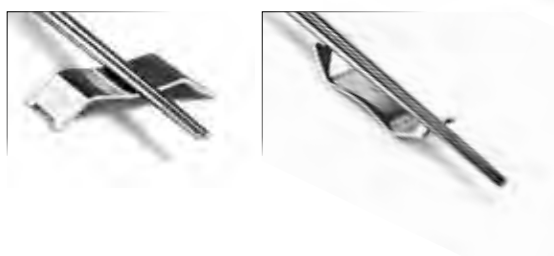

Cucchiaino cereali

Cereal spoon
Cuillère à céréales
Cerealienlöffel
Cuchara de cereales

Acciaio Inox - St. Steel

	mm	in
908 05 00 006	185	7,1/4

**Cucchiaino tè/moka**

Tea spoon
Cuillère à moka
Tee-/Mokalöffel
Cuchara de moka

Acciaio Inox - St. Steel

	mm	in
908 05 00 003	120	4,3/4

**Paletta miscelatore**

Coffee stirrer
Agitateur à café
Kaffee-Rührer
Paleta café

Acciaio Inox 18/10 - St. Steel 18/10

	mm	in
908 05 00 005	100	4

**Cucchiaino spatolina**

Spatula spoon
Cuillère spatule
Spatel - Spatenlöffel
Cuchinilla spatula

Acciaio Inox 18/10 - St. Steel 18/10

	mm	in
908 05 00 002	149	6

**Cucchiaino yogurt/cioccolato/marmellata**

Yogurt / chocolate / jam spoon
Cuillère à yaourt / chocolat / confiture
Joghurt / Schokoladen / Marmeladenlöffel
Cuchara yogur / chocolate / mermelada

Acciaio Inox 18/10 - St. Steel 18/10

	mm	in
908 05 00 001	121	4,3/4



Cucchiaio moka appetizer con foro Linea

Linea moka spoon appetizer with hole
 Cuillère à moka de mise en bouche avec trou Linea
 Appetizer Mokalöffel mit Lock Linea
 Cuchara moka aperitivo con agujero Linea

Acciaio Inox 18/10 - St. Steel 18/10

	mm	in
CF7P 22F	106	4,1/8

**Cucchiaio caffè' appetizer Linea**

Linea tea spoon appetizer
 Cuillère à thé de mise en bouche Linea
 Appetizer Kaffee/Teelöffel Linea
 Cuchara café aperitivo Linea

Acciaio Inox 18/10 - St. Steel 18/10

	mm	in
CF7P 21	122	4,3/4

**Forchetta 2 punte appetizer Linea**

Linea fork appetizer, two-prong
 Fourchette de mise en bouche à deux dents Linea
 Appetizer Zweizinkengabel Linea
 Tenedor aperitivo dos puntas Linea

Acciaio Inox 18/10 - St. Steel 18/10

	mm	in
CF7P 63	105	4,1/8

**Cucchiaio moka appetizer Linea**

Linea moka spoon appetizer
 Cuillère à moka de mise en bouche Linea
 Appetizer Mokalöffel Linea
 Cuchara moka aperitivo Linea

Acciaio Inox 18/10 - St. Steel 18/10

	mm	in
CF7P 22	106	4,1/8

**Cucchiaio bibita appetizer Linea**

Linea cocktail spoon
 Cuillère à mazagan Linea
 Cocktailöffel Linea
 Cuchara refresco Linea

Acciaio Inox 18/10 - St. Steel 18/10

	mm	in
CF7P 35	210	8,1/4

**Cucchiaino moka con decoro fiore**

Moka spoon with flower decoration
 Cuillère à moka avec decoration fleure
 Mokkalöffel mit beÜhmendekor
 Cucharita moka con decoración flor

Acciaio Inox 18/10 - St. Steel 18/10

	mm	in
CDE 22F	103	4

**Cucchiaino moka con decoro rombo**

Moka spoon with rhombus decoration
 Cuillère à moka avec decoration losange
 Mokkalöffel mit karodekor
 Cucharita moka con decoración rombo

Acciaio Inox 18/10 - St. Steel 18/10

	mm	in
CDE 22S	103	4

**Cucchiaino moka con decoro stella**

Moka spoon with star decoration
 Cuillère à moka avec decoration étoile
 Mokkalöffel mit sterndekor
 Cucharita moka con decoración estrella

Acciaio Inox 18/10 - St. Steel 18/10

	mm	in
CDE 22Q	103	4



Cucchiaino caffè Svezia

Svezia coffee spoon
 Cuillère à café Svezia
 Kaffee/Teelöffel Svezia
 Cuchara café Svezia

Acciaio Inox - St. Steel

	mm	in
CSV 21	140	5,1/2

**Cucchiaino moka Svezia**

Svezia moka spoon
 Cuillère à moka Svezia
 Mokalöffel Svezia
 Cuchara moka Svezia

Acciaio Inox - St. Steel

	mm	in
CSV 22	105	4,1/8

**Cucchiaino bibita Svezia**

Svezia cocktail spoon
 Cuillère à cocktail Svezia
 Cocktaillöffel Svezia
 Cuchara refresco Svezia

Acciaio Inox - St. Steel

	mm	in
CSV 35	204	8

**Forchetta dolce Svezia**

Svezia cake fork
 Fourchette à gâteau Svezia
 Kuchengabel Svezia
 Tenedor lunch Svezia

Acciaio Inox - St. Steel

	mm	in
CSV 38	145	5,3/4

**Cucchiaino gelato Svezia**

Svezia ice cream spoon
 Cuillère à glace Svezia
 Eislöffel Svezia
 Cuchara helado Svezia

Acciaio Inox - St. Steel

	mm	in
CSV 37	131	5,1/8



Cucchiaino moka Riflesso

Riflesso moka spoon
Cuillère à moka Riflesso
Mokalöffel Riflesso
Cuchara moka Riflesso

Acciaio Inox 18/10 - St. Steel 18/10

	mm	in
C33P 22	108	4,3/8

**Cucchiaino caffè Riflesso**

Riflesso coffee spoon
Cuillère à café Riflesso
Kaffee/Teelöffel Riflesso
Cuchara café Riflesso

Acciaio Inox 18/10 - St. Steel 18/10

	mm	in
C33P 21	130	5,7/8

**Paletta gelato Riflesso**

Riflesso ice cream spoon
Cuillère à glace Riflesso
Eislöffel Riflesso
Cuchara helado Riflesso

Acciaio Inox 18/10 - St. Steel 18/10

	mm	in
C33P 37	130	5,1/8

**Cucchiaino bibita Riflesso**

Riflesso cocktail spoon
Cuillère à cocktail Riflesso
Cocktailöffel Riflesso
Cuchara refresco Riflesso

Acciaio Inox 18/10 - St. Steel 18/10

	mm	in
C33P 35	201	7,7/8

**Cucchiaino caffè con piega Riflesso**

Riflesso s-shaped tea spoon
Cuillère à thé pliée
Riflesso - Gebogener Teelöffel Riflesso
Cucharita café plegada Riflesso

Acciaio Inox 18/10 - St. Steel 18/10

	mm	in
C33P 392	115	4,1/2

**Cucchiaino bibita con piega Riflesso**

Riflesso s-shaped cocktail spoon
Cuillère à mazagran pliée Riflesso
Gebogener Cocktailöffel Riflesso
Cuchara refresco plegada Riflesso

Acciaio Inox 18/10 - St. Steel 18/10

	mm	in
C33P 394	185	7,1/4

**Forchettina dolce Riflesso**

Riflesso cake fork
Fourchette à gâteau Riflesso
Kuchengabel Riflesso
Tenedor lunch Riflesso

Acciaio Inox 18/10 - St. Steel 18/10

	mm	in
C33P 38	144	5,3/4

**Forchettina 2 punte Riflesso**

Riflesso two-prong fork
Fourchette à deux dents Riflesso
Zweizinkengabel Riflesso
Tenedor dos puntas Riflesso

Acciaio Inox 18/10 - St. Steel 18/10

	mm	in
C33P 63	144	5,3/4



Cucchiaino caffè bar

Bar coffee spoon
Cuillère à café bar
Kaffee/Teelöffel Bar
Cuchara café bar

Acciaio Inox - St. Steel

	mm	in
903 06 81 020	133	5,1/8

**Cucchiaino moka 903**

903 Moka spoon
Cuillère à moka 903
Mokalöffel 903
Cuchara moka 903

Acciaio Inox - St. Steel

	mm	in
903 06 81 024	111	4,3/8

**Cucchiaio fragola e confetti Milord**

Milord sweet spoon
Cuillère à sucreries Milord
Erdbeer- und Konfektlöffel Milord
Cuchara para dulces Milord

Acciaio Inox 18/10 - St. Steel 18/10

	mm	in
C14 36	170	6,5/8

**Cucchiaio fragola e confetti Imperial**

Imperial sweet spoon
Cuillère à sucreries Imperial
Erdbeer- und Konfektlöffel Imperial
Cuchara para dulces Imperial

Acciaio Inox 18/10 - St. Steel 18/10

	mm	in
C04 36	170	6,5/8

**Cucchiaio olive con fori**

Olive slotted spoon
Cuillère de mise en bouche olives perforée
Gelochter Oliven Löffel
Cuchara aceitunas perforada

Acciaio Inox 18/10 - St. Steel 18/10

	mm	in
903 05 81 AOF	225	8,7/8

**Cucchiaio olive**

Olive spoon
Cuillère de mise en bouche olives
Oliven Löffel
Cuchara aceitunas

Acciaio Inox 18/10 - St. Steel 18/10

	mm	in
903 05 81 AOL	225	8,7/8



Cucchiaio multiuso Matisse grande

Matisse slotted spoon large
 Cuillère à servir perforée Matisse grande
 Großer Universallöffel Matisse
 Cuchara para servir perforada Matisse grande

Acciaio Inox 18/10 - St. Steel 18/10

	mm	in
CF1 162	205	8,1/8

**Cucchiaio ghiaccio Matisse grande**

Matisse slotted long ice spoon
 Cuillère à glaçons perforée Matisse grande
 Großer Eiswürfelloffel Matisse
 Cucharón hielo perforado Matisse grande

Acciaio Inox 18/10 - St. Steel 18/10

	mm	in
CF1 253	205	8,1/8

**Cucchiaio multiuso Matisse piccolo**

Matisse slotted spoon
 Cuillère à servir perforée Matisse
 Kleiner Universallöffel Matisse
 Cuchara para servir perforada Matisse

Acciaio Inox 18/10 - St. Steel 18/10

	mm	in
CF1 161	170	6,5/8

**Cucchiaio ghiaccio Matisse piccolo**

Matisse slotted ice spoon
 Cuillère à glaçons perforée Matisse
 Kleiner Eiswürfelloffel Matisse
 Cuchara hielo perforada Matisse

Acciaio Inox 18/10 - St. Steel 18/10

	mm	in
CF1 251	170	6,5/8

**Cucchiaio multiuso Pop**

Pop slotted spoon
 Cuillère à servir perforée Pop
 Universallöffel Pop
 Cuchara para servir perforada Pop

Acciaio Inox 18/10 - St. Steel 18/10

	mm	in
CD4 162	202	7,8/8

**Cucchiaio ghiaccio Pop**

Pop slotted ice spoon
 Cuillère à glaçons perforée Pop
 Eiswürfelloffel Pop
 Cucharón hielo perforado Pop

Acciaio Inox 18/10 - St. Steel 18/10

	mm	in
CD4 253	202	7,8/8



Abert presenta Double, il nuovo utensile per... l'assaggio!

innovativo: grazie alla sua forma metà cucchiaio e metà forchetta è l'unico strumento in grado di permettere assaggi di cibi liquidi e solidi.

Irrinunciabile per gli chef, che possono finalmente sperimentare tutte le loro preparazioni con un solo oggetto nel taschino.

ingegnoso e pratico per assaporare i cibi in occasione di degustazioni, aperitivi o buffet.

Abert presents Double, the new tool for... tasting!

innovative: thanks to its shape half spoon and half fork, it is an instrument able to allow tastes of liquid and solid foods.

Essential for chefs, who can at last experiment all their preparations with just one object in their small pocket.

ingenious and practical in order to savour foods at tastings, happy hours or buffets.

Double

Double
Double
Doppel
Double

Acciaio Inox 18/10 - St. Steel 18/10

	mm	in
903 05 81 DFS	165	6,1/2

**Appetizer Matisse con riccio**

Curled appetizer
Cuillère de mise en bouche en boucle
Appetizerlöffel
Aperitivo con nudo - cuchara

Acciaio Inox 18/10 - St. Steel 18/10

		mm	in
CF1 CR	SPOON	141	5,1/2
CF1 FR	FORK	136	5,3/8

**Appetizer Matisse con piega - cucchiaio**

Bended appetizer spoon
Cuillère de mise en bouche pliée
Appetizerlöffel
Aperitivo plegada - cuchara

Acciaio Inox 18/10 - St. Steel 18/10

		mm	in
CF1 CP	SPOON	142	5,1/2
CF1 FP	FORK	138	5,3/8

**Appetizer Brigitte con piega**

Bended appetizer spoon Brigitte
Mise en bouche pliée Brigitte
Appetizerlöffel Brigitte
Aperitivo plegada Brigitte

Acciaio Inox 18/10 - St. Steel 18/10

	mm	in	
C68 CP	142	5,1/2	SPOON
C68 FP	142	5,1/2	FORK



Forchettina appetizer segnaposto

Place-card appetizer fork
 Fourchette de mise en bouche marque-place
 Tischkarte Appetizer Gabel
 Tenedor aperitivo etiqueta

Acciaio Inox 18/10 - St. Steel 18/10

	H mm	H in
903 05 81 APF	97	3,7/8

**Tapas Matisse**

Matisse Tapas
 Cuillère Tapas Matisse
 Tapas Matisse
 Tapas Matisse

Acciaio Inox 18/10 - St. Steel 18/10

	mm	in
CF1 TA	170	6,3/4

**Cucchiaio appetizer tondo**

Appetizer curved spoon
 Cuillère de mise en bouche ronde pliée
 Appetizer - rund gebogener Löffel
 Cuchara aperitivo redonda plegada

Acciaio Inox 18/10 - St. Steel 18/10

	mm	in
903 05 81 APC	140	5,1/2

**Mini appetizer Ego**

Ego mini appetizer
 Mini mise en bouche Ego
 Mini Appetizer Ego
 Mini aperitivo Ego

Acciaio Inox 18/10 - St. Steel 18/10

	mm	in	
CD3 38M	115	4,1/2	FORK
CD3 22	115	4,1/2	SPOON

**Forchetta 3 punte mini Niagara**

Niagara fork two-prong mini
 Fourchette Niagara à deux dents mini
 Tenedor Niagara de dos puntas mini
 Gabel Niagara mit 3 Spitzen

Acciaio Inox 18/10 - St. Steel 18/10

	mm	in
CZ338M	115	4,1/2

**Cucchiaino moka Niagara**

Niagara moka spoon
 Cuillère moka Niagara
 Cuchara moka Niagara
 Moka Löffel

Acciaio Inox 18/10 - St. Steel 18/10

	mm	in
CZ322	113	4,1/2



Coltello carne Modern seghettato

Modern steak knife
 Couteau à bifteck Modern
 Modern Steakmesser
 Cuchillo carne Modern

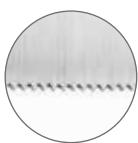
**Acciaio Inox - St. Steel / ABS**

	mm	in
903 06 86 A	227	9

Coltello carne Modern filo rasoio

Modern steak knife
 Couteau à bifteck Modern
 Modern Steakmesser
 Cuchillo carne Modern

**Acciaio Inox - St. Steel / ABS**

	mm	in
903 06 86 B	227	9

Coltello Angus seghettato

Angus steak knife
 Couteau à bifteck Angus
 Angus Steakmesser
 Cuchillo carne Angus

**Acciaio Inox - St. Steel / POM**

	mm	in
CAN 55	229	9

Coltello Angus filo rasoio

Angus steak knife
 Couteau à bifteck Angus
 Angus Steakmesser
 Cuchillo carne Angus

**Acciaio Inox - St. Steel / POM**

	mm	in
CAN 55R	229	9

Coltello carne Kansas

Kansas steak knife
 Couteau à bifteck Kansas
 Kansas Steakmesser
 Cuchillo carne Kansas

Acciaio Inox - St. Steel / POM

	mm	in
CKA 55	218	8,5/8



Coltello carne Kobe

Kobe steak knife
 Couteau à bifteck Kobe
 Kobe Steakmesser
 Cuchillo carne Kobe

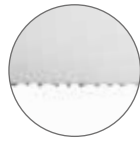

Acciaio Inox - St. Steel
Legno - Wood

	mm	in
CKO 55	244	9,5/8

Coltello carne Kobe

Kobe steak knife
 Couteau à bifteck Kobe
 Kobe Steakmesser
 Cuchillo carne Kobe



Acciaio Inox - St. Steel
Legno - Wood

	mm	in
CKO 55R	244	9,5/8

Coltello carne Fuego

Fuego steak knife
 Couteau à bifteck Fuego
 Fuego Steakmesser
 Cuchillo carne Fuego



Acciaio Inox - St. Steel / ABS

	mm	in
CFU 55	232	9

Coltello carne Fuego

Fuego steak knife
 Couteau à bifteck Fuego
 Fuego Steakmesser
 Cuchillo carne Fuego



Acciaio Inox - St. Steel / ABS

	mm	in
CFU 55R	232	9

**Coltello carne Texas
seghettato - serrated blade**

Texas steak knife
Couteau à bifteck Texas
Texas Steakmesser
Cuchillo carne Texas

**Acciaio Inox - St. Steel
Legno - Wood**

	Mm	In
CAN 55 LC	235	9,1/4

**Coltello carne Texas
filo rasoio - razor-edge**

Texas steak knife
Couteau à bifteck Texas
Texas Steakmesser
Cuchillo carne Texas

**Acciaio Inox - St. Steel
Legno - Wood**

	Mm	In
CAN 55 LCR	235	9,1/4

**Coltello carne Memphis
seghettato - serrated blade**

Memphis steak knife
Couteau à bifteck Memphis
Memphis Steakmesser
Cuchillo carne Memphis

**Acciaio Inox - St. Steel
Legno - Wood**

	Mm	In
CKO 55 LC	250	9.7/8

**Coltello carne Memphis
filo rasoio - razor-edge**

Memphis steak knife
Couteau à bifteck Memphis
Memphis Steakmesser
Cuchillo carne Memphis

**Acciaio Inox - St. Steel
Legno - Wood**

	Mm	In
CKO 55 LCR	250	9.7/8

**Coltello carne Safari
seghettato - serrated blade**

Safari steak knife
Couteau à bifteck Safari
Safari Steakmesser
Cuchillo carne Safari

**Acciaio Inox - St. Steel
Legno - Wood**

	Mm	In
CE5 A5 5LC	235	9,1/4

**Coltello carne Safari
filo rasoio - razor-edge**

Safari steak knife
Couteau à bifteck Safari
Safari Steakmesser
Cuchillo carne Safari

**Acciaio Inox - St. Steel
Legno - Wood**

	Mm	In
CE5 A5 5LCR	235	9,1/4

Blister coltelli carne Rost punta

Rost steak knives blister
Blister de couteaux à viande Rost
Fleischmesser Rost Blisterpackung
Blister cuchillos carne Rost

AVARI 064B 06 pcs 6
AVARI 064B 12 pcs 12



Blister coltelli carne Rost punta tonda

Rost steak knives round point blister
Blister de couteaux à viande Rost pointe ronde
Fleischmesser Rost Blisterpackung
Blister cuchillos carne Rost

AVARI 064T B06 pcs 6
AVARI 064T B12 pcs 12



Blister coltelli pizza Rost

Pizza knives Rost blister
Blister de couteaux à pizza Rost
Rost Pizzamesser Blisterpackung
Blister cuchillos pizza Rost

AVARI 064P B06 pcs 6
AVARI 064P B12 pcs 12



Coltello fiorentina

Fiorentina steak knife
 Couteau à bifteck Fiorentina
 Fiorentina Steakmesser
 Cuchillo carne Fiorentina

Acciaio Inox 18/10 - St. Steel 18/10

	mm	in
CFI 55	230	9

**Forchetta fiorentina**

Fiorentina steak fork
 Fourchette à bifteck Fiorentina
 Fiorentina Steakgabel
 Tenedor carne Fiorentina

Acciaio Inox 18/10 - St. Steel 18/10

	mm	in
CFI 02	204	8

**Coltello carne Pampero**

Pampero steak knife
 Couteau à bifteck Pampero
 Pampero Steakmesser
 Cuchillo carne Pampero

Acciaio Inox - St. Steel

	mm	in
CPP 55	222	8,5/8

**Forchetta carne Pampa**

Pampa steak fork
 Fourchette à bifteck Pampa
 Pampa Steakgabel
 Tenedor carne Pampa

Acciaio Inox 18/10 - St. Steel 18/10

	mm	in
CPA 52	197	7,5/8

**Coltello carne Malaga**

Malaga steak knife
 Couteau à bifteck Malaga
 Malaga Fleischmesser
 Cuchillo carne Malaga

Acciaio Inox - St. Steel

	mm	in
CMA 55	231	8,5/8

**Forchetta carne Altozano/Malaga**

Altozano steak fork
 Fourchette à bifteck Altozano
 Altozano Steakgabel
 Tenedor carne Altozano

Acciaio Inox - St. Steel

	mm	in
CAL 52	205	8



Coltello pizza Azzurra

Azzurra pizza knife
Couteau à pizza Azzurra
Azzurra Pizzamesser
Cuchillo pizza Azzurra

Acciaio Inox - St. Steel

	mm	in
CZ 7134	225	8,7/8

**Forchetta pizza Azzurra**

Azzurra pizza fork
Fourchette à pizza Azzurra
Azzurra Pizzagabel
Tenedor pizza Azzurra

Acciaio Inox - St. Steel

	mm	in
CZ 752	200	7,7/8

**Coltello pizza Modern acciaio**

Modern pizza knife
Couteau à pizza Modern
Modern Pizzamesser
Cuchillo pizza Modern

Acciaio Inox - St. Steel

	mm	in
CPI 05P	205	8

**Forchetta pizza Modern acciaio**

Modern pizza fork
Fourchette à pizza Modern
Modern Pizzagabel
Tenedor pizza Modern

Acciaio Inox - St. Steel

	mm	in
CPI 02 CR	203	7,7/8

**Coltello carne America monoblocco**

America steak knife, solid handle
Couteau à bifteck America monobloc
Steakmesser America, monoblock
Cuchillo carne America monobloque

Acciaio Inox - St. Steel

	mm	in
C46 55	210	9

**Coltello carne Modern acciaio**

Modern steak knife
Couteau à bifteck Modern
Modern Steakmesser
Cuchillo carne Modern

Acciaio Inox - St. Steel

	mm	in
CPI 05	226	8,7/8



Coltello pizza Palio

Pizza knife Palio
 Couteau à pizza Palio
 Palio Pizzamesser
 Cuchillo pizza Palio

Acciaio Inox - St. Steel

	mm	in
CC3 134	210	8,1/4

**Coltello carne Pampero / C**

Pampero steak knife
 Couteau à bifteck Pampero
 Pampero Steakmesser
 Cuchillo carne Pampero

Acciaio Inox - St. Steel

	mm	in
CPP 55/C	222	8,5/8

**Forchetta carne Ergo**

Ergo steak fork
 Fourchette à bifteck Ergo
 Ergo Steakgabel
 Tenedor carne Ergo

Acciaio inox 18/10 - St-Steel 18/10

CE552

**Coltello carne Rost punta**

Rost steak knife
 Couteau à viande Rost
 Fleischmesser Rost
 Cuchillo carne Rost

Acciaio Inox manico nero

AVARI064T

**Pampa forchetta carne**

Pampa steak fork
 Fourchette à bifteck
 Carne/Bistecca Tenedor chuletero
 Pampa Pampa Steakgabel

Acciaio inox 18/10 - St-Steel 18/10

CPA52 L.197mm

Pampa forchetta carne

Pampa steak fork
 Fourchette à bifteck
 Carne/Bistecca Tenedor chuletero
 Pampa Pampa Steakgabel

Acciaio inox 18/10 - St-Steel 18/10 - CR

CPA52C L.197mm



Pinza aragosta forgiata

Lobster cracker, forged
Pince à homard forgé
Langustezange - geschmieden
Pinzas langosta forjadas

Acciaio Inox - St. Steel

	mm	in
305 05 91 658	210	8,1/4

**Stiletto aragosta**

Lobster pick
Fourchette à homard
Langustegabel
Tenedor langosta

Acciaio Inox 18/10 - St. Steel 18/10

	mm	in
903 05 84 659	202	7,7/8

**Forchettina ostriche**

Oyster fork
Fourchette à crustacés
Austerngabel
Tenedor ostras

Acciaio Inox 18/10 - St. Steel 18/10

	mm	in
CF1 64	156	6,1/8

**Stiletto ostriche/crostacei**

Oyster fork
Fourchette à crustacés
Krustengabel
Tenedor mariscos

Acciaio Inox 18/10 - St. Steel 18/10

	mm	in
CPA 64	227	8,7/8

**Forchettina 2 punte Matisse**

Matisse fork, two-prong
Fourchette à deux dents Matisse
Zweizinkengabel Matisse
Tenedor dos puntas Matisse

Acciaio Inox 18/10 - St. Steel 18/10

	mm	in
CF1 63	156	3,1/8

**Molla lumache**

Snail tongs
Pince à escargots
Schneckenzange
Pinzas caracoles

Acciaio Inox - St. Steel

	mm	in
903 05 81 MLU	160	6,1/4



Coltello formaggi cremosi Regis Spalmy

Spalmy creamy cheese knife
 Couteau à fromages crèmeux Spalmy
 Schmelzkäsemesser Spalmy
 Cuchillo quesos cremosos Spalmy

Acciaio Inox - St. Steel

	mm	in
903 05 84D	225	8,7/8

**Coltello paste molli Regis Tommy**

Tommy tender cheese knife
 Couteau à fromages à pâte molle Tommy
 Weichkäsemesser Tommy
 Cuchillo quesos pasta blanda Tommy

Acciaio Inox - St. Steel

	mm	in
903 05 84A	218	8,5/8

**Coltello 2 punte Regis Emmy**

Emmy medium-hard cheese knife
 Couteau à fromages à pâte demi-ferme Emmy
 Milderkäsemesser Emmy
 Cuchillo quesos pasta semi-dura Emmy

Acciaio Inox - St. Steel

	mm	in
903 05 84B	221	8,5/8

**Coltello formaggi di paste crude Regis Parmy**

Parmy hard cheese knife
 Couteau à fromages à pâte ferme Parmy
 Hartkäsemesser Parmy
 Cuchillo quesos pasta dura Parmy

Acciaio Inox - St. Steel

	mm	in
903 05 84C	199	7,7/8

**Coltello formaggelle Regis Formy**

Formy formaggelle soft cheese knife
 Couteau à fromages à pâte molle formaggelle Formy
 Frischkäsemesser Formy
 Cuchillo quesos pasta blanda formaggelle Formy

Acciaio Inox - St. Steel

	mm	in
903 05 84E	273	10,5/8

**Coltello agrumi Regis**

Regis citrus fruit knife
 Couteau à agrumes Regis
 Orangenmesser Regis
 Cuchillo cítricos Regis

Acciaio Inox - St. Steel

	mm	in
903 05 84 269	220	8,5/8



Schiaccianoci forgiato

Nut cracker - forged
Casse noix forgé
Nußknacker geschmieden
Cascanueces forjado

Acciaio Inox 18/10 - St. Steel 18/10

	mm	in
AVARI 117	150	6

**Schiaccianoci**

Nut cracker
Casse noix
Nußknacker
Cascanueces

Acciaio Inox 18/10 - St. Steel 18/10

	mm	in
903 05 84 163	220	8,5/8

**Paletta raccoglibriciole**

Crumb sweeper
Pelle ramasse-miettes
Krümelsammler
Pala recogemigas

Acciaio Inox 18/10 - St. Steel 18/10

	mm	in
903 05 91 939	160	6,1/4

**Easy Spaghetti e pasta 3 in 1****Dosaspaghetti - Assaggiaspaghetti - Assaggiapasta**

Spaghetti doser - Spaghetti taster - Pasta taster
Doseur spaghetti - Goute-spaghetti - Goute-pâtes
Spaghetti-Maß - Spaghettitester - Nudel-Tester
Dosificador de espagueti - Prueba espagueti - Prueba pasta

Acciaio Inox 18/10 - St. Steel 18/10

	mm	in
903 05 81 ESP	225	8,7/8

**Affettaformaggio Regis**

Regis cheese slicer
Pelle coupe-fromage Regis
Käsehobel Regis
Pala corta queso Regis

Acciaio Inox - St. Steel

	mm	in
903 05 84 135	190	7,1/2



Forchettone spaghetti

Spaghetti serving fork
Fourchette à servir spaghetti
Spaghettigabel
Tenedor servir spaghetti

Acciaio Inox 18/10 - St. Steel 18/10

	mm	in
903 05 91 792	278	11

**Mestolo punch**

Punch ladle
Louche à punch
Punch Schöpflöffel
Cazo punch Svezia

Acciaio Inox 18/10 - St. Steel 18/10

	mm	in
CSV 66	280	11

**Cucchiaio insalata con piega Pivot**

Pivot curved salad spoon
Grosse cuillère à salade pliée Pivot
Gebogene Salatlöffel Pivot
Cuchara ensalada plegada Pivot

Acciaio Inox 18/10 - St. Steel 18/10

	mm	in
CD8 28	255	10,1/8

**Forchetta insalata con piega Pivot**

Pivot curved salad fork
Grosse fourchette à salade pliée Pivot
Gebogene Salatgabel Pivot
Tenedor ensalada plegado Pivot

Acciaio Inox 18/10 - St. Steel 18/10

	mm	in
CD8 29	255	10,1/8

**Cucchiaio forato multiuso con piega Pivot**

Pivot curved slotted spoon
Cuillère perforée à servir pliée Pivot
Gebogener, gelochter Universallöffel Pivot
Cuchara perforada para servir plegada Pivot

Acciaio Inox 18/10 - St. Steel 18/10

	mm	in
CD8 162	255	10,1/8

**Cucchiaio ghiaccio multiuso con piega Pivot**

Pivot slotted long ice spoon
Cuillère à glaçons / salade pliée Pivot
Gebogener Universaleislöffel Pivot
Cucharón hielo / ensalada plegado Pivot

Acciaio Inox 18/10 - St. Steel 18/10

	mm	in
CD8 253	255	10,1/8



Mestolo con piega

S-shaped soup ladle
 Louche pli e
 Gebogener Sch opfl offel
 Cazo sopa plegado

Acciaio Inox 18/10 - St. Steel 18/10

	mm	in
C00 25CP	275	10,7/8

**Cucchiaio macedonia con piega**

S-shaped fruit salad spoon
 Cuill re   salade de fruits pli e
 Gebogener Obstsalatl offel
 Cuchara ensalada de frutas plegada

Acciaio Inox 18/10 - St. Steel 18/10

	mm	in
C00 27CP	215	8,1/2

**Forchetta multiuso con piega**

S-shaped fork
 Fourchette pli e
 Gebogene Universalgabel
 Tenedor plegado

Acciaio Inox 18/10 - St. Steel 18/10

	mm	in
C00 26CP	215	8,1/2

**Cucchiaio servi miele con piega**

S-shaped honey serving spoon
 Cuill re   miel pli e
 Gebogener Honigl offel
 Cuchara para miel plegada

Acciaio Inox 18/10 - St. Steel 18/10

	mm	in
C89 390	140	5,1/2



Cucchiaione riso professionale

Professional rice-serving spoon
Cuillère à riz professionnelle
Reislöffel
Cucharón arroz profesional

Acciaio Inox 18/10 - St. Steel 18/10

	mm	in	spessore / thickness
903 05 91 795	256	10	2,5 mm

**Pala fritto professionale**

Professional frying palette
Pelle à friture professionnelle
Schaufel
Pala frito profesiona

Acciaio Inox 18/10 - St. Steel 18/10

	mm	in	spessore / thickness
903 05 91 062	295	11,5/8	2.5 mm

**Cucchiaione forato professionale**

Professional slotted serving spoon
Cuillère perforée professionnelle
Gelochter Löffel
Cucharón servir perforado profesional

Acciaio Inox 18/10 - St. Steel 18/10

	mm	in	spessore / thickness
903 05 91 796	290	11,1/2	2,5 mm

**Cucchiaione ghiaccio professionale**

Professional ice-serving spoon
Cuillère à glaçons professionnelle
Eislöffel
Cucharón hielo profesional

Acciaio Inox 18/10 - St. Steel 18/10

	mm	in	spessore / thickness
903 05 91 063	290	11,1/2	2.5 mm

**Cucchiaione insalata professionale**

Professional salad-serving spoon
Cuillère à salade professionnelle
Salatlöffel
Cucharón ensalada profesional

Acciaio Inox 18/10 - St. Steel 18/10

	mm	in	spessore / thickness
903 05 91 066	285	11,1/4	2,5 mm

**Cucchiaione servire professionale**

Professional serving spoon
Cuillère à servir professionnelle
Löffel
Cucharón servir profesional

Acciaio Inox 18/10 - St. Steel 18/10

	mm	in	spessore / thickness
903 05 91 793	290	11,1/2	2.5 mm

**Cucchiato riso forato professionale**

Professional rice-serving spoon
Cuillère à riz professionnelle
Reislöffel
Cucharón arroz profesional

Acciaio Inox 18/10 - St. Steel 18/10

	mm	in	spessore / thickness
903 05 91 795 F	256	10	2,5 mm

**Mestolo professionale**

Professional ladle
Louche professionnelle
Professionelle Schöpfkelle
Cazo profesional

Acciaio Inox 18/10 - St. Steel 18/10

	mm	in	spessore / thickness
903 05 91 025	288	11,3/4	2.5 mm



Forchettone servire professionale

Professional serving fork
Fourchette à servir professionnelle
Gabel
Tenedor servir profesional

Acciaio Inox 18/10 - St. Steel 18/10

	mm	in	spessore / thickness
903 05 91 794	294	11,5/8	2.5 mm

**Forchettone arrosto professionale**

Professional carving fork
Grande fourchette rôti professionnelle
Fleischgabel
Tenedor asado profesional

Acciaio Inox 18/10 - St. Steel 18/10

	mm	in	spessore / thickness
903 05 91 064	285	11,1/4	2.5 mm

**Coltello torta seghettato professionale**

Professional serrated-edge cake knife
Couteau à gâteau professionnel lame dentelée
Kuchmesser
Cuchillo pastel profesional dentado

Acciaio Inox 18/10 - St. Steel 18/10

	mm	in	spessore / thickness
903 05 91 788	297	11,3/4	2.5 mm

seghettato / serrated

**Coltello torta professionale**

Professional cake knife
Couteau à gâteau professionnel
Tortmesser
Cuchillo pastel profesional

Acciaio Inox 18/10 - St. Steel 18/10

	mm	in	spessore / thickness
903 05 91 798	297	11,3/4	2.5 mm

**Pala torta seghettata professionale**

Professional serrated-edge cake server
Pelle à gâteau dentelée professionnelle
Tortenschaufel
Pala pastel profesional dentada

Acciaio Inox 18/10 - St. Steel 18/10

	mm	in	spessore / thickness
903 05 91 786	297	11,3/4	2.5 mm

**Pala torta professionale**

Professional cake server
Pelle à gâteau professionnelle
Tortenschaufel
Pala pastel profesional

Acciaio Inox 18/10 - St. Steel 18/10

	mm	in	spessore / thickness
903 05 91 799	297	11,3/4	2.5 mm

**Spatola crepes professionale**

Professional crepes server
Spatule à crêpes professionnelle
Crepesschaufel
Pala crepes profesional

Acciaio Inox 18/10 - St. Steel 18/10

	mm	in	spessore / thickness
903 05 91 065	292	11,1/2	2.5 mm

**Pala gratin professionale**

Professional gratin server
Pelle à gratin professionnelle
Backschaufel
Pala lasaña profesional

Acciaio Inox 18/10 - St. Steel 18/10

	mm	in	spessore / thickness
903 05 91 787	268	10,5/8	2.5 mm
seghettata / serrated			
903 05 91 797	268	10,5/8	2.5 mm



Molla insalata o vegetali

Salad-vegetable tongs
Pince à légumes
Gemüsezange
Pinza para ensalada

Acciaio Inox - St. Steel

	mm	in
CI 18601	195	7,5/8

**Molla servire**

Serving tongs
Pince à servir
Servierzange
Pinza de servicio

Acciaio Inox - St. Steel

	mm	in
CI 18602	195	7,5/8

**Molla asparagi**

Asparagus tongs
Pince à asperges
Spargelzange
Pinza para espàrragos

Acciaio Inox - St. Steel

	mm	in
CI 18603	195	7,5/8

**Molla pasta**

Pasta tongs
Pince pasta
Pastazange
Pinza pasta

Acciaio Inox - St. Steel

	mm	in
CI 18604	195	7,5/8

**Molla dolci / toast**

Cake tongs
Pince à pâtisserie
Gebäckzange
Pinza para pasteles

Acciaio Inox - St. Steel

	mm	in
CI 18703	180	7

**Forbici servire pane**

Pastry/bread scissors/tongs
Bread serving scissors tongs
Pince ciseaux à servir pain
Pinzas tijeras para servir pan Brot-Servierzange

Acciaio Inox 18/10 - St. Steel 18/10

	mm	in
9030581FPA	250	8,7/8

**Forbici servire pasticceria**

Pastry/bread scissors/tongs
Pastry serving scissors Ciseaux à servir gâteau
Tijeras para servir pastelería
Gebäck-Servierzange

Acciaio Inox 18/10 - St. Steel 18/10

	mm	in
9030581FPS	210	8,1/4

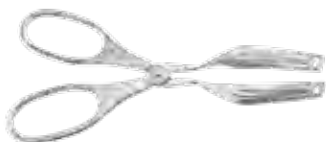
**Forbici servire arrosto**

Roast scissors/tongs
Roast serving scissors tongs
Ciseaux à servir rôti
Tijeras para servir asado Fleisch-Servierzange

Acciaio Inox 18/10 - St. Steel 18/10

	mm	in
9030581FAR	250	8,7/8



Molla per pane Cosmos

Cosmos bread tongs
Pince à pain Cosmos
Brotzange Cosmos
Pinzas pan Cosmos

Acciaio Inox - St. Steel

	mm	in
● V53 05 81 MPA 15	225	8,7/8
● V53 05 81 MPA 34	225	8,7/8
● V53 05 81 MPA 41	225	8,7/8
● V53 05 81 MPA 43	225	8,7/8
● V53 05 81 MPA 47	225	8,7/8

**Molla per spaghetti Cosmos**

Cosmos spaghetti tongs
Pince à spaghetti Cosmos
Spghettizange Cosmos
Pinzas spaghetti Cosmos

Acciaio Inox - St. Steel

	mm	in
● V53 05 81 MSP 15	230	9,1/8
● V53 05 81 MSP 34	230	9,1/8
● V53 05 81 MSP 41	230	9,1/8
● V53 05 81 MSP 43	230	9,1/8
● V53 05 81 MSP 47	230	9,1/8

**Molla per arrosto Cosmos**

Cosmos roast tongs
Pince à rôti Cosmos
Braten/Fleischzange Cosmos
Pinzas asado Cosmos

Acciaio Inox - St. Steel

	mm	in
● V53 05 81 MAR 15	220	8,5/8
● V53 05 81 MAR 34	220	8,5/8
● V53 05 81 MAR 41	220	8,5/8
● V53 05 81 MAR 43	220	8,5/8
● V53 05 81 MAR 47	220	8,5/8

**Molla per dolce Cosmos**

Cosmos cake tongs
Pince à gâteau Cosmos
Gebäckzange Cosmos
Pinzas postre Cosmos

Acciaio Inox - St. Steel

	mm	in
● V53 05 81 MDO 15	220	8,5/8
● V53 05 81 MDO 34	220	8,5/8
● V53 05 81 MDO 41	220	8,5/8
● V53 05 81 MDO 43	220	8,5/8
● V53 05 81 MDO 47	220	8,5/8

**Molla per ghiaccio Cosmos**

Cosmos ice tongs
Pince à glace Cosmos
Eiszange Cosmos
Pinzas hielo Cosmos

Acciaio Inox - St. Steel

	mm	in
● V53 05 81 MGH 15	214	8,3/8
● V53 05 81 MGH 34	214	8,3/8
● V53 05 81 MGH 41	214	8,3/8
● V53 05 81 MGH 43	214	8,3/8
● V53 05 81 MGH 47	214	8,3/8



Molla arrosto Modern

Roast tongs
Pince à rôti
Fleischzange
Pinzas asado

Acciaio Inox - St. Steel

	mm	in
903 05 81 MAR	250	8,7/8

**Molla dolci Modern**

Cake tongs
Pince à gâteaux
Gebäckzange
Pinzas postre

Acciaio Inox - St. Steel

	mm	in
903 05 81 MDO	250	8,7/8

**Molla ghiaccio Modern**

Ice tongs
Pince à glaçons
Eiszange
Pinzas hielo

Acciaio Inox - St. Steel

	mm	in
903 05 81 MGH	200	7,7/8

**Molla spaghetti Modern**

Spaghetti tongs
Pince à spaghetti
Spaghettizange
Pinzas spaghetti

Acciaio Inox - St. Steel

	mm	in
903 05 81 MSP	250	8,7/8



Molla insalata Long

Salad tongs
Pince à salade
Salatzange
Pinzas ensalada

Acciaio Inox - St. Steel

	mm	in
903 05 81 MIN	270	10,5/8

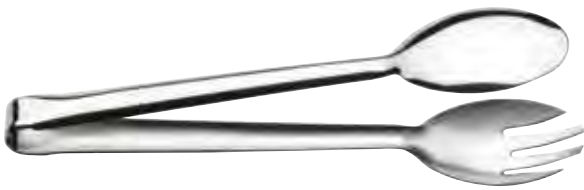
**Molla pasta Long**

Pasta tongs
Pince à pâtes
Pastazange
Pinzas pasta

Acciaio Inox - St. Steel

	mm	in
903 05 81 MPA	270	10,5/8

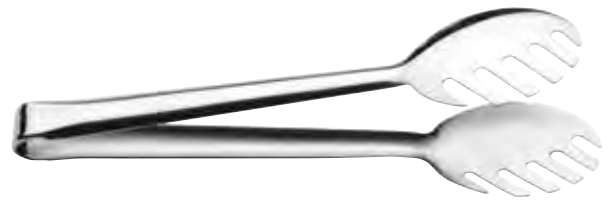
**Molla multiuso Long**

Multipurpose tongs
Pince à servir
Multipurposezange
Pinzas para servir

Acciaio Inox - St. Steel

	mm	in
903 05 81 MMU	295	11,5/8

**Molla Universal Long**

Universal tongs
Pince Universal
Universalzange
Pinzas Universal

Acciaio Inox - St. Steel

	mm	in
903 05 81 MUN	270	10,5/8



Molla ghiaccio deluxe

De luxe ice tongs
Pince à glaçons de luxe
Eiszange de luxe
Pinzas hielo de luxe

Acciaio Inox - St. Steel

	cm	in
903 06 81 MGD	15,6	6,1/8

**Molla pane**

Bread tongs
Pince à pain
Brotzange
Pinzas pan

Acciaio Inox - St. Steel

	cm	in
903 06 81 MPA	20	7,7/8

**Molla spaghetti**

Spaghetti tongs
Pince à spaghetti
Spaghetizange
Pinzas spaghetti

Acciaio Inox - St. Steel

	cm	in
903 06 81 MSP	20,2	7,7/8

**Molla dolci**

Cake tongs
Pince à gâteau
Gebäckzange
Pinzas postre

Acciaio Inox - St. Steel

	cm	in
903 06 81 MDL	18,9	7,1/2

**Molla arrosto**

Roast tongs
Pince à rôti
Fleisch/Servierzange
Pinzas asado

Acciaio Inox - St. Steel

	cm	in
903 06 81 MAR	21	8,1/4

**Molla universale**

Universal tongs
Pince universelle
Universalzange
Pinzas universales

Acciaio Inox - St. Steel

	cm	in
903 06 81 MUN	23,5	9,1/4



Molla zucchero

Sugar tongs
Pince à sucre
Zuckerzange
Pinzas azucar

Acciaio Inox - St. Steel

	cm	in
903 06 81 MZU	14,1	5,1/2

**Molla ghiaccio piccola**

Small ice tongs
Pince à glaçons petite
Eiszange - klein
Pinzas hielo pequeñas

Acciaio Inox - St. Steel

	cm	in
903 06 81 MGP	11,8	4,3/4

**Forbici insalata**

Salad tongs (scissors type)
Pince ciseaux à salade
Salatzange
Pinzas ensalada tipo tijeras

Acciaio Inox - St. Steel

	cm	in
903 06 81 FIN	20	7,7/8

**Forbici dolci**

Cake tongs (scissors type)
Pince ciseaux à gâteaux
Scherenzange
Pinzas postre tipo tijeras

Acciaio Inox - St. Steel

	cm	in
903 06 81 FDO	19,5	7,5/8

**Molla gastronomica**

Culinary tongs
Pince culinaire
Gastronomischer Frühling
Pinzas culinario

Acciaio Inox - St. Steel

	mm	in
CI 180 00	155	6,1/8

**Molla affettati**

Salami tongs
Pince charcuterie
Wurstwarenfeder
Pinzas charcutería

Acciaio Inox - St. Steel

	mm	in
903 05 81 MAF C1	105	4,1/8







TAVOLA • TABLE

Caffettiera Imperial

Imperial coffeepot
Cafetière Imperial
Kaffekanne Imperial
Cafetera Imperial

Acciaio Inox 18/10 - St. Steel 18/10

	Cl	Oz
V01 05 01 035	35	12
V01 05 01 060	60	20
V01 05 01 100	100	35
V01 05 01 150	150	51
V01 05 01 200	200	68

**Teiera Imperial**

Imperial teapot
Théière Imperial
Teekanne Imperial
Tetera Imperial

Acciaio Inox 18/10 - St. Steel 18/10

	Cl	Oz
V01 05 02 035	35	12
V01 05 02 060	60	20
V01 05 02 100	100	35
V01 05 02 130	130	44

**Lattiera Imperial**

Imperial milkpot
Pot à lait Imperial
Milchkanne Imperial
Lechera Imperial

Acciaio Inox 18/10 - St. Steel 18/10

	Cl	Oz
V01 05 03 035	35	12
V01 05 03 060	60	20
V01 05 03 100	100	35

**Cremiera Imperial**

Imperial creamer
Crémier Imperial
Sahnekännchen Imperial
Jarrita de leche Imperial

Acciaio Inox 18/10 - St. Steel 18/10

	Cl	Oz
V01 05 03 015	15	5



Caraffa termica Imperial

Imperial thermal beverage server
Carafe thermos Imperial
Thermoskanne Imperial
Jarra térmica Imperial

Acciaio Inox 18/10 - St. Steel 18/10

	Cl	Oz
V01 05 08 T06	70	24
V01 05 08 T10	100	35
V01 05 08 T15	150	51
V01 05 08 T20	200	68

**Zuccheriera con maniglie Imperial**

Imperial sugar pot with lid and handles
Sucrier avec couvercle et poignées Imperial
Zuckerdose mit Griffen und Deckel Imperial
Azucarero con tapa y asas Imperial

Acciaio Inox 18/10 - St. Steel 18/10

	Gr	Oz
V01 05 04 280	280	10

**Brocca acqua Imperial**

Imperial water pitcher
Carafe à eau Imperial
Wasserkrug Imperial
Jarra agua Imperial

Acciaio Inox 18/10 - St. Steel 18/10

	Cl	Oz
V01 05 08 150	150	51
V01 05 08 200	200	68

**Zuccheriera Imperial**

Imperial sugar pot
Sucrier Imperial
Zuckerdose Imperial
Azucarero Imperial

Acciaio Inox 18/10 - St. Steel 18/10

	Gr	Oz
V01 05 04 200	200	7



Caffettiera

Coffeepot
Cafetière
Kaffekanne
Cafetera

Acciaio inossidabile - St. Steel

	tazze/cup	cl
906 05 044	2	15
906 05 045	4	30
906 05 045X	5	45
906 05 046	6	65
906 05 047	9	110

**Lattiera**

Milkpot
Pot à lait
Milchkanne
Lechera

Acciaio inossidabile - St. Steel

	tazze/cup	cl
906 05 048	2	15
906 05 049	4	30
906 05 049X	5	45
906 05 050	6	65
906 05 051	9	110

**Zuccheriera**

Sugar pot
Sucrier
Zuckerdose
Azucarero

Acciaio inossidabile - St. Steel

	gr
906 05 064	200Ferio excest, consecuiata que



Portacannucce

Straw holder
Porte-pailles
Trinkhalmbehälter
Portapajitas

Acciaio Inox 18/10 - St. Steel 18/10

	ø cm	ø in	H cm	H in
V01 05 71 011	9	3,1/2	11	4,3/8

**Portacucchiaini**

Tea spoon holder
Porte-cuillères à café
Kaffeelöffelbecher
Portacucharas café

Acciaio Inox 18/10 - St. Steel 18/10

	ø cm	ø in	H cm	H in
V01 05 71 008	9	3,1/2	8	3,1/8

**Portabustine zucchero/the**

Rectangular sugar tray
Sucrier rectangulaire
Zucker-Behälter
Azucarero rectangular

Acciaio Inox 18/10 - St. Steel 18/10

	cm	in	H cm	H in
V78 05 04 PBU	10x6,5	4	3,5	1,3/8

**Passatè (colino tè) con coppetta**

Tea strainer
Passoire à the
Teesieb
Colador de te

Acciaio Inox 18/10 - St. Steel 18/10

	cm	H cm	in	H in
V01 05 91 001	9,5x5	3	3,3/4x2	1,1/8



Portauovo

Egg cup
Coquetier
Eierbecher
Huevera

Acciaio Inox - St. Steel

	ø cm	ø in
V01 05 71 001	8,6	3,3/8

**Burriera piccola con coperchio**

Small butter dish with cover
Petit beurrier avec cloche
Klein Butterschale mit Deckel
Mantequera pequeña con tapa

Acciaio Inox 18/10 - St. Steel 18/10

	ø cm	ø in
V01 05 09 107	7	2,3/4
Z01 20 09 107	7	2,3/4 porcellana/porcelain

**Burriera con coperchio**

Butter dish with cover
Beurrier avec cloche
Butterschale mit Deckel
Mantequera con tapa

Acciaio Inox 18/10 - St. Steel 18/10

	ø cm	ø in
V01 05 09 115	15	6
Z01 20 09 115	15	6 porcellana/porcelain

**Portasalatini 3 scomparti**

3-tier snack/relish dish
Porte-biscuits salés à 3 compartiments
Salzgebäckschale, 3-tlg
Entremesera 3 sectores

Acciaio Inox 18/10 - St. Steel 18/10

	ø cm	ø in
V01 05 41 003	10,5	4,1/8



Portamarmellata per 4 confezioni

4-jar jam holder

Porte-confiture pour 4 pots

Konfitürenschaale, 4 tlg

Dispensador de mermelada para 4 botes

Acciaio Inox 18/10 - St. Steel 18/10

	cm	in
V76 05 09 001	18x45	7,1/8x1,3/4

**Portamarmellata 3 scomparti**

3-tier jam dish

Porte-confiture à 3 compartiments

Konfitürenschaale, 3 tlg

Dispensador de mermelada 3 sectores

Acciaio Inox 18/10 - St. Steel 18/10

	Ø cm	H cm	Ø in	H in
V01 05 09 003	6	13	2,3/8	5,1/8

**Portamarmellata 6 scomparti**

6-tier jam dish

Porte-confiture à 6 compartiments

Konfitürenschaale, 6 tlg

Dispensador de mermelada 6 sectores

Acciaio Inox 18/10 - St. Steel 18/10

	Ø cm	H cm	Ø in	H in
V01 05 09 006	6	17,5	2,3/8	6,7



Alzata pasticceria

Petit four stand
Support à pâtisserie
Petits-Fours-Ständer
Presentación pastelería

Acciaio Inox 18/10 - St. Steel 18/10

	ø cm	H cm	ø in	H in
V36 05 41 012	12	13	4,3/4	5,1/8
V36 05 41 016	16	13	6,1/4	5,1/8
V36 05 41 022	22	13	8,5/8	5,1/8

**Alzata pasticceria 2 piani**

2-tier petit four stand
Support à pâtisserie à 2 étages
Petits-fours ständer 2-stufig
Presentación pastelería 2 pisos

Acciaio Inox 18/10 - St. Steel 18/10

	ø cm	H cm	ø in	H in
V36 05 41 201	16-12	17	6,1/4-4,3/4	6.3/4
V36 05 41 202	22-16	17	8,5/8-6,1/4	6.3/4

**Alzata pasticceria 3 piani**

3-tier petit four stand
Support à pâtisserie à 3 étages
Kuchenständer 3-stufig
Presentación pastelería 3 pisos

Acciaio Inox 18/10 - St. Steel 18/10

	ø cm	H cm	ø in	H in
V36 05 41 301	22-16-12	30	8,5/8-6,1/4-4,3/4	11.3/4



Alzata pasticceria

Petit four stand
Support à pâtisserie
Petits-Fours-Ständer
Presentación pastelería

Acciaio Inox 18/10 - St. Steel 18/10

	ø cm	H cm	ø in	H in
V01 05 41 012	12	11	4,3/4	4,3/8
V01 05 41 016	16	11,5	6,1/4	4,1/2
V01 05 41 022	22	12	8,5/8	4,3/4

**Alzata pasticceria 2 piani**

2-tier petit four stand
Support à pâtisserie à 2 étages
Petits-fours ständer 2-stufig
Presentación pastelería 2 pisos

Acciaio Inox 18/10 - St. Steel 18/10

	ø cm	H cm	ø in	H in
V01 05 41 201	12/16	21,5	4,3/4-6,1/4	8,1/2
V01 05 41 202	16/22	22,5	6,1/4-8,5/8	8,7/8

**Alzata pasticceria 3 piani**

3-tier petit four stand
Support à pâtisserie à 3 étages
Kuchenständer 3-stufig
Presentación pastelería 3 pisos

Acciaio Inox 18/10 - St. Steel 18/10

	ø cm	H cm	ø in	H in
V01 05 41 301	12/16/22	31	4,3/4-6,1/4-8,5/8	12,1/4



Servitore té/pasticceria

Afternoon tea stand
Stand thé/pâtisserie
Tee/Kuchenstander
Soporte para platos

Acciaio Inox 18/10 - St. Steel 18/10

	ø cm	H cm	ø in	H in	ø interno
V76 05 42 005	30,6	42	12	16,1/2	18,3
V76 05 42 004	28	40	11	15,3/4	21,8

**Alzata torta**

Cake stand
Surtout
Kuchenteller
Bandeja para tarta

Acciaio Inox 18/10 - St. Steel 18/10

	ø cm	H cm	ø in	H in
CI 22600	32	3,5	12,5/8	1,3/8

**Alzata torta**

Cake stand
Présentoir à gâteau
Tortenplatte
Presentación tarta

Acciaio Inox 18/10 - St. Steel 18/10

	ø cm	H cm	ø in	H in
V01 05 42 022	22	9,5	8,5/8	3,3/4
V01 05 42 032	32	12,5	12,5/8	12,5
V01 05 42 042	42	16,5	16,1/2	6,1/2

**Alzata torta 3 piani**

3-tier cake stand
Présentoir à gâteau 3 étages
Kuchenständer 3-stufig
Presentación tarta 3 pisos

Acciaio Inox 18/10 - St. Steel 18/10

	ø cm	H cm	ø in	H in
V01 05 42 301	22/32/42	43,5	8,5/8-12,5/8-16,1/2	17,1/8



Alzata frutta

Fruit stand
 Serviteur à fruits
 Obstständler
 Frutero

Acciaio Inox 18/10 - St. Steel 18/10

	ø cm	H cm	ø in	H in
V77 05 42 126	22	12,5	8,5/8	5
V77 05 42 132	29	12,5	11,3/8	5
V77 05 42 138	36,5	12,5	14,3/8	5

**Alzata frutta 2 piani**

2-tier fruit stand
 Serviteur fruits à 2 étages
 Obstständler 2-stufig
 Frutero 2 pisos

Acciaio Inox 18/10 - St. Steel 18/10

	ø cm	H cm	ø in	H in
V77 05 42 226	22/29	22,5	8,5/8-11,3	8-8,7/8

**Alzata frutta 3 piani**

3- tier fruit stand
 Serviteur à fruits 3 étages
 Obstständler 3-stufig
 Frutero 3 pisos

Acciaio Inox 18/10 - St. Steel 18/10

	ø cm	H cm	ø in	H in
V77 05 42 326	22/29/36,5/44	8,5/4	11,3/8/14,3/8	17,3/8



Sottopiatto bordo inglese

Show plate with English decoration

Plat à présentation avec décoration anglaise

Platzteller mit englischer Dekoration

Plato de presentación con borde inglés

Acciaio Inox 18/10 - St. Steel 18/10

	ø cm	ø in
V01 05 25 I32	31,5	12,3/8

**Sottopiatto liscio**

Show plate, plain

Plat à présentation simple

Platzteller

Plato de presentación liso

Acciaio Inox 18/10 - St. Steel 18/10

	ø cm	ø in
V01 05 25 032	31	12,1/4

**Sottobottiglia**

Bottle coaster

Sous bouteille

Flaschenuntersatz

Posabotella

Acciaio Inox 18/10 - St. Steel 18/10

	ø cm	ø in
V01 05 21 014	14	5,1/2

**Sottobicchiere**

Glass coaster

Sous verre

Untersatz

Posavasos

Acciaio Inox 18/10 - St. Steel 18/10

	ø cm	ø in
V01 05 21 011	11	4,3/8



Cestino pane rettangolare Square

Bread basket Square, rectangular
 Corbeille à pain rectangulaire Square
 Brotkorb Square, rechteckig
 Cesta pan rectangular Square

Acciaio Inox 18/10 - St. Steel 18/10

	cm	in
V76 05 24 002	20x12	7,7/8x4,3/4

**Cestino pane rettangolare Square**

Bread basket Square, rectangular
 Corbeille à pain rectangulaire Square
 Brotkorb Square, rechteckig
 Cesta pan rectangular Square

Acciaio Inox 18/10 - St. Steel 18/10

	cm	in
V76 05 24 003	27x12	10,5/8x4,3/4

**Panno per cestino pane c/velcro ecru**

Cloth for bread basket, beige
 Tissu pour corbeille à pain écru
 Sandfarbenes Tuch für Brotkorb
 Paño para cesta pan beige

	cm	in
AS9 1CP	27	10,5/8

Cestino in filo agrumi

Citrus-fruit basket

Corbeille à agrumes

Obstkorb Edelstahl Draht für Zitrusfrüchte

Cesta cítricos

Acciaio Inox 18/10 - St. Steel 18/10

	ø cm	H cm	ø in	H in
906 05 001	21 cm	20	8,1/4	7,7/8

**Cestino frutta tondo in filo**

Fruit basket, round, wire

Corbeille a fruits ronde en fil d'acier

Drahtobstkorb, rund

Cesta frutas redonda en hilo

Acciaio Inox 18/10 - St. Steel 18/10

	ø cm	H cm	ø in	H in
906 05 004	25	9	9,7/8	3,1/2

**Cestino frutta tondo in filo**

Fruit basket, round, wire

Corbeille a fruits ronde en fil d'acier

Drahtobstkorb, rund

Cesta frutas redonda en hilo

Acciaio Inox 18/10 - St. Steel 18/10

	ø cm	H cm	ø in	H in
906 05 003	20	8	7,7/8	3,1/8

**Cestino frutta tondo in filo**

Fruit basket, round, wire

Corbeille a fruits ronde en fil d'acier

Drahtobstkorb, rund

Cesta frutas redonda en hilo

Acciaio Inox 18/10 - St. Steel 18/10

	ø cm	H cm	ø in	H in
906 05 002	18	7	7,1/8	2,3/4



Cestino ovale in filo

Oval s/s basket
 Corbeille ovale
 Ovalkorb Edelstahl Draht
 Cesta oval

Acciaio Inox 18/10 - St. Steel 18/10

	cm	H cm	in	H in
906 05 016	28x21	9	11x8,1/4	3,1/2

**Cestino ovale in filo**

Oval s/s basket
 Corbeille ovale
 Ovalkorb Edelstahl Draht
 Cesta oval

Acciaio Inox 18/10 - St. Steel 18/10

	cm	H cm	in	H in
906 05 015	25x18	8	9,7/8x7	3,1/8

**Cestino ovale in filo**

Oval s/s basket
 Corbeille ovale
 Ovalkorb Edelstahl Draht
 Cesta oval

Acciaio Inox 18/10 - St. Steel 18/10

	cm	H cm	in	H in
906 05 014	20x15	7	7,7/8x6	2,3/4





Cestino pane e frutta Cacao con manico in pelle

Cacao bread and fruit basket - with leather handle
 Corbeille à pain et fruits Cacao - avec anses en cuir
 Cacao Brotkorb und Fruchtkakao - mit Ledergriff
 Cesto de pan y fruta Cacao - con asas de piel

Acciaio Inox 18/10 - St. Steel 18/10 + E.P. - E.L.

	Cm	In
V05 05 24 M18	18x18	7x7
V05 05 24 M23	23x23	9x9

**Secchio cacao con manico in ecopelle**

Cacao bucket with leather handle
 Seau Cacao avec manche en cuir
 Champagnekühler mit Eimer Cacao (Griff aus Leder)
 Cubo Cacao con mango de cuero

Acciaio Inox 18/10 - St. Steel 18/10 + E.P. - E.L.

	Ø Cm	H. Cm	Ø In	H. In
V36 05 20 M01	19	19,5	7,1/2	7,5/8
V36 05 20 M02	13	12	5,1/8	4,3/4



Cestino pane liscio Majorca

Mallorca bread basket, plain
 Corbeille à pain Mallorca
 Brotkorb Mallorca
 Cesta pan Mallorca lisa

Acciaio Inox 18/10 - St. Steel 18/10

	cm	in
V05 05 24 L18	18,5x18,5	7,1/4 x7,1/4
V05 05 24 L23	23x23	9x9

**Cestino pane forato Majorca**

Mallorca bread basket, slotted
 Corbeille à pain Mallorca, perforée
 Lochbrotkorb Mallorca
 Cesta pan con agujeros Mallorca

Acciaio Inox 18/10 - St. Steel 18/10

	cm	in
V05 05 24 F18	18,5x18,5	7,1/4 x7,1/4
V05 05 24 F23	23x23	9x9

**Cestino pane ovale**

Bread basket, oval
 Corbeille à pain ovale
 Brotkorb, oval
 Cesta pan oval

Acciaio Inox 18/10 - St. Steel 18/10

	cm	in
V01 05 24 028	28x15	11x6



**Anello adattatore**

Adjusting ring
Bague de réglage
Einsatzring
Anillo adaptador

Acciaio Inox 18/10 - St. Steel 18/10

	cm	in
V01 05 43 540	13 cm	5,1/8

**Coppetta interna**

Supreme inside cup
Coupe intérieure
Schale
Copita interior

Acciaio Inox 18/10 - St. Steel 18/10

	cm	in
V01 05 43 562	10,5	4,1/8

**Piattino portaburro**

Butter dish
Plat à beurre
Butterschale
Platito mantequilla

Acciaio Inox 18/10 - St. Steel 18/10

	ø cm	ø in
V01 05 43 648	13	5,1/8

**Griglia portaburro**

Butter grid
Grille porte-beurre
Buttergitter
Parrilla mantequilla

Acciaio Inox 18/10 - St. Steel 18/10

	ø cm	ø in
V01 05 43 539	13	5,1/8

**Coppa esterna base**

Supreme outside base cup
Coupe base extérieure Supreme
Schale auf Fuß
Copa exterior base Supreme

Acciaio Inox 18/10 - St. Steel 18/10

	ø cm	ø in
V01 05 43 130	13	5,1/8

**Coppa Supreme completa**

Supreme cup
Coupe Supreme
Hummer-/Cocktailschale
Copa Supreme, completa

Acciaio Inox 18/10 - St. Steel 18/10

	ø cm	H cm	ø in	H in
V01 05 43 C13	13	8,5	5,1/8	3,3/8
3 Pezzi - 3 Pieces				
V01 05 43 C135	13	8,5 cm	5,1/8	3,3/8
5 Pezzi - 5 Pieces				

CESTINI PANE IN COTONE
 cuscino con noccioli di ciliegia,
riscaldabile. I cestini sono confezionati
 in pratici cavallotti a blister su cui
 sono stampate tutte le informazioni,
 comprese quelle di utilizzo e lavaggio.

COTTON BREAD BASKET
 pillow with cherry stones, **heated**. The
 bread baskets come in practical hangable
 packs with all the information, including
 use and washable.



FASCIA APPENDIBILE
 hanging card



made in italy
 made in Italy





Sacchetto porta pane

Bread basket
Corbeille à pain
Brotkorb
Cesta pan

Cotone - Cotton

	ø cm	H cm	ø in	H in
■ AVARI 206	21	25	8,1/4	9,7/8
■ AVARI 207	21	25	8,1/4	9,7/8



Cestino pane

Bread basket
Corbeille à pain
Brotkorb
Cesta pan

Cotone - Cotton

	cm	H cm	in	H in
■ AVARI 161B	11x11	15	4,3/8x 4,3/8	5,7/8
■ AVARI 163B	18x18	18	7,1/8x7,1/8	7,1/8



Cestino pane

Bread basket
Corbeille à pain
Brotkorb
Cesta pan

Cotone - Cotton

	cm	H cm	in	H in
■ AVARI 162B	11x11	15	4,3/8x 4,3/8	5,7/8
■ AVARI 164B	18x18	18	7,1/8x7,1/8	7,1/8



Cestino pane bicolore

Bread basket
Corbeille à pain
Brotkorb
Cesta pan

Cotone e poliestere - Cotton and polyester

	ø cm	H cm	ø in	H in
■ AVARI 211	17	8	6,3/4	3,1/8
■ AVARI 212	20	9	7,7/8	3,1/2

Cuscino termico con noccioli

Thermal cushion
Coussin chauffant
Wärmekissen
Cojín térmico

Cotone - Cotton

	cm	in
■ 325 05 24 579	11x11	4,3/8x 4,3/8
■ 325 05 24 580	18x18	7,1/8x7,1/8

**Cestino pane con cuscino**

Bread basket with cushion
Corbeille à pain avec coussin
Brotkorb mit Kissen
Cesta pan con cosin

Cotone - Cotton

	cm	in	Pz
■ AVARI 151	11x11x15	4,3/8x4,3/8x5,7/8	1
■ AVARI 150	11x11x15	4,3/8x4,3/8x5,7/8	1
■ AVARI 153	18x18x18	7,1/8x7,1/8x7,1/8	1
■ AVARI 152	18x18x18	7,1/8x7,1/8x7,1/8	1

**Cestino pane**

Bread basket
Corbeille à pain
Brotkorb
Cesta pan

Cotone - Cotton

	cm	in	Pz
■ AVARI 162	11x11x15	4,3/8x4,3/8x5,7/8	1
■ AVARI 161	11x11x15	4,3/8x4,3/8x5,7/8	1
■ AVARI 164	18x18x18	7,1/8x7,1/8x7,1/8	1
■ AVARI 163	18x18x18	7,1/8x7,1/8x7,1/8	1

**Cestino pane**

Bread basket
Corbeille à pain
Brotkorb
Cesta pan

Cotone - Cotton

	cm	in	Pz
■ AVARI 154	11x11x15	4,3/8x4,3/8x5,7/8	3
■ AVARI 155	11x11x15	4,3/8x4,3/8x5,7/8	3
■ AVARI 156	18x18x18	7,1/8x7,1/8x7,1/8	2
■ AVARI 157	18x18x18	7,1/8x7,1/8x7,1/8	2



Adatti all'utilizzo con i cuscini vedi P.24
Suitable for use with pillows P.24



Cestino pane

Bread basket
Corbeille à pain
Brotkorb
Cesta pan

Cotone - Cotton

	cm	H cm	in	H in
■ AVARI 200	14x14	8	5,1/2x5,1/2	3,1/8
■ AVARI 203	19x19	10	7,1/2x7,1/2	3,7/8



Cestino pane

Bread basket
Corbeille à pain
Brotkorb
Cesta pan

Cotone / Cotton

	cm	H cm	in	H in
■ AVARI 201	14x14	8	5,1/2x5,1/2	3,1/8
■ AVARI 204	19x19	10	7,1/2x7,1/2	3,7/8



Cestino pane

Bread basket
Corbeille à pain
Brotkorb
Cesta pan

Juta

	cm	H cm	in	H in
■ AVARI 202	14x14	8	5,1/2x5,1/2	3,1/8
■ AVARI 205	19x19	10	7,1/2x7,1/2	3,7/8



Cestino portabustine mignon

Tea/Sugar bag basket, small
Corbeille à sachets de thé/sucre petite
Klein Stoffkorb, Tee und Zuckerbeutelbehälter
Cestita para bolsitas de té/ azúcar pequeña

Juta

	cm	H cm	in	H in
■ AVARI 208	6x8	6	2,3/8x3,1/8	2,3/8
■ AVARI 209	6x8	6	2,3/8x3,1/8	2,3/8
■ AVARI 210	6x8	6	2,3/8x3,1/8	2,3/8

Set breakfast

Breakfast set
Service petit déjeuner
Tablet mit Frühstückzubehören
Set desayuno

Acciaio Inox 18/10 - St. Steel 18/10

	cm	in
V76 05 23 002	24	9,1/2

**Set lunch**

Lunch set
Service lunch
Öl und Essig set Tablett
Set almuerzo

Acciaio Inox 18/10 - St. Steel 18/10

	cm	in
V76 05 23 003	24	9,1/2

**Set sauces appetizer**

Set sauces appetizer
Service sauces-appetizer
Söße und Apertiven set Soßen
Set salsas-aperitivos

Acciaio Inox 18/10 - St. Steel 18/10

	cm	in
V76 05 23 004	24	9,1/2



Vetro salino Square c/tappo

Glass cruet salt spreader Square w/cap
 Verre pour salière Square avec couvercle
 Salzstreuer mit Schraubverschluss
 Vidrio salero Square c/tapa

Acciaio Inox - St. Steel

V76 05 12 001

**Ampolla olio/aceto Square c/tappo**

Glass cruet oil/vinegar set Square w/cap
 Burette huile/vinaigre Square avec bouchon
 Essig/Ölglasflasche mit Schraubverschluss
 Alcuza aceite/vinagre Square c/tapa

Acciaio Inox - St. Steel

V76 05 11 001

**Portatovaglioli Square**

Napkin holder
 Porte-serviettes
 Serviettenhalter
 Servilletero

Acciaio Inox 18/10 - St. Steel 18/10

	cm	H cm	in	H in
V76 05 71 001	11x4	8	4,3/8x1,2/3	3,1/8

**Portabustine zucchero/tè**

Packed sugar/tea holder
 Conteneur sachets de sucre/té
 Zucker-Teebeutelbehälter
 Porta sobres de azúcar/té

Acciaio Inox 18/10 - St. Steel 18/10

	cm	H cm	in	H in
V78 05 04 PBU	10x6,5	3,5	3,7/8x2,1/2	1,3/8

**Ciotola porcellana quadra**

Porcelain square bowl
 Bol carré en porcelaine
 Porzellanschale, viereckig
 Bol cuadrado de porcelana

Porcelain

	cm	in
V86 21 42 CQ7	7x7	2,3/4x2,3/4

**Vaso Formaggiiera con coperchio**

Cheese bowl
 Ravier a parmesan
 Käsedose
 Quesera

Acciaio Inox - St. Steel

V76 05 13 002



Coppa macedonia Imperial

Fruit salad cup
Coupe à dessert
Obstsalatschale
Copa macedonia

Acciaio Inox 18/10 - St. Steel 18/10

	ø cm	ø in	H cm	H in
V01 05 43 125	12,5	5	5,5	2

**Coppa gelato**

Ice cream cup
Coupe à glace
Eisschale
Copa helado

Acciaio Inox 18/10 - St. Steel 18/10

	ø cm	ø in
V01 05 43 105	10,5	4,1/8

**Coppa gelato Imperial**

Imperial ice cream cup
Coupe à glace Imperial
Eisschale Imperial
Copa helado Imperial

Acciaio Inox 18/10 - St. Steel 18/10

	ø cm	ø in	H cm	H in
V01 05 43 010	9,5	3,3/4	10	4

**Piattino sottocoppa**

Cup saucer
Plat sous coupe
Untersatz
Platito posacopa

Acciaio Inox 18/10 - St. Steel 18/10

	ø cm	ø in
V01 05 21 013	13	5,1/8

**Portafiori**

Flower vase
Vase à fleurs
Blumenvase
Florero

Acciaio Inox 18/10 - St. Steel 18/10

	H cm	H in
V01 05 19 015	16,5	6,1/2

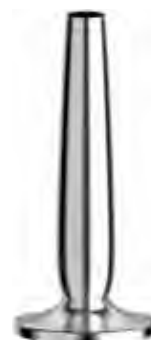

Vassoio multiuso

Multipurpose tray
Plateau universelle
Universale Platte
Bandeja universal

Acciaio Inox 18/10 - St. Steel 18/10

	cm	in
CI 3005	24x9,5	9,1/2x3,3/4

**Salsiera con piattino**

Sauce boat with underliner
Saucière avec soucoupe
Soßenschüssel mit Tellerchen
Salsera con platito

Acciaio Inox 18/10 - St. Steel 18/10

	Cl	mm
V61 05 12 030	30	0,8

**Salsiera**

Sauce boat
Saucière
Soßenschüssel
Salsera

Acciaio Inox 18/10 - St. Steel 18/10

	Cl	mm
CI 25401	10	0,8
CI 25402	20	0,8
CI 25403	30	0,8

**Cloche**

Dome cover
Cloche
Speiseglocke
Campana

Acciaio Inox 18/10 - St. Steel 18/10

	ø cm	ø in
V01 05 53 024	24	9,1/2
V01 05 53 026	26	10,1/4
V01 05 53 028	28	11
V01 05 53 030	30	11,3/4



Portatovaglioli

Napkin holder
Porte-serviette
Serviettenhalter
Servilletero

Acciaio Inox 18/10 - St. Steel 18/10

	cm	H cm	in	H in
V01 05 71 105	10,5	9	4,1/8	3,1/2

**Portatovaglioli**

Napkin holder
Porte-serviettes
Serviettenhalter
Servilletero

Acciaio Inox 18/10 - St. Steel 18/10

	cm	H cm	in	H in
V76 05 71 001	11x4	8	4,3/8x1,2/3	3,1/8

**Portatovaglioli quadrato**

Napkin holder, square
Porte-serviette carré
Viereckiger Serviettenhalter
Servilletero cuadrado

Acciaio Inox 18/10 - St. Steel 18/10

	cm	H cm	in	H in
V01 05 71 190	19x19	7	7,1/2x7,1/2	2,3/4

**Portakleenex**

Kleenex holder
Porte-kleenex
Taschentücherhalter
Porta kleenex

Acciaio Inox 18/10 - St. Steel 18/10

	cm	H cm	in	H in
V01 05 71 002	22x12	5,5	8,5/8x4,3/4	2,1/8

**Lavadita**

Finger bowl
Rince-doigts
Fingerschale
Lavadedos

Acciaio Inox 18/10 - St. Steel 18/10

	ø cm	ø in
V01 05 43 012	12	4,3/4



Portatovaglioli da banco verticale

Vertical napkin holder

Porte-serviettes vertical

Vertikaler Thekenserviettenhalter

Servilletero cuadrado vertical

Acciaio Inox 18/10 - St. Steel 18/10

	cm	H cm	in	H in
906 05 008	8,5x11	16	3,3/8x4,3/8	6,1/4

**Legatovaglioli tondo**

Round napkin ring

Rond de serviette

Serviettenhalter

Servilletero redondo

Acciaio Inox 18/10 - St. Steel 18/10

	ø cm	ø in
V01 05 81 001	4 cm	1,2/3

**Paletta raccoglibriciole**

Crumb sweeper

Pelle ramasse-miettes

Krümelsammler

Pala recogemigas

Acciaio Inox 18/10 - St. Steel 18/10

	cm	in
903 05 91 939	12	4,3/4

**Legatovaglioli ovale**

Oval napkin ring

Rond de serviettes ovale

Serviettenhalter, oval

Servilletero oval

Acciaio Inox 18/10 - St. Steel 18/10

	cm	in
V01 05 81 000	5x4	2x1,2/3



Coperchio legumiera/zuppiera

Cover for vegetable dish/soup tureen

Couvercle pour soupière/légumier

Deckel für Suppen-Gemüseschüssel

Tapa legumbrera/sopera

Acciaio Inox 18/10 - St. Steel 18/10

	ø cm	ø in
V01 05 15 C14	14	5,1/2
V01 05 15 C18	18	7,1/8
V01 05 15 C22	22	8,5/8
V01 05 15 C24	24	9,1/2
V01 05 15 C26	26	10,1/4
V01 05 15 C28	28	11
V01 05 15 C30	30	11,3/4

**Zuppiera**

Soup tureen

Soupière

Suppenschüssel

Sopera

Acciaio Inox 18/10 - St. Steel 18/10

	ø cm	ø in	lt	Oz
V01 05 15 Z14	14	5,1/2	0,75	25
V01 05 15 Z18	18	7,1/8	1,5	50
V01 05 15 Z22	22	8,5/8	2,5	85
V01 05 15 Z24	24	9,1/2	3,5	118
V01 05 15 Z26	26	10,1/4	4,25	144
V01 05 15 Z28	28	11	5,25	178
V01 05 15 Z30	30	11,3/4	6,5	220

**Legumiera**

Vegetable dish

Légumier

Gemüseschüssel

Legumbrera

Acciaio Inox 18/10 - St. Steel 18/10

	ø cm	ø in	lt	Oz
V01 05 15 L14	14	5,1/2	0,8	27
V01 05 15 L18	18	7,1/8	1,4	47
V01 05 15 L22	22	8,5/8	1,9	64
V01 05 15 L24	24	9,1/2	2,8	94,6
V01 05 15 L26	26	10,1/4	3,8	128,5
V01 05 15 L28	28	11	4,8	162



Runner - grigio scuro

Runner, dark grey
Chemin de table gris foncé
Runner dunkelgrau
Camino de mesa gris oscuro

70% Pvc - 30% Pet

	cm	in
AVARI TO 31	45x120	17,3/4x47,2

**Runner - grigio chiaro**

Runner, light grey
Chemin de table gris clair
Runner hellgrau
Camino de mesa gris claro

70% Pvc - 30% Pet

	cm	in
AVARI TO 30	45x120	17,3/4x47,2

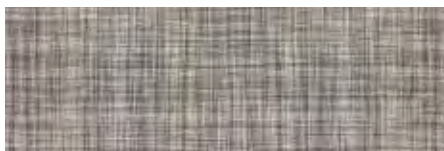
**Runner - grigio tortora**

Runner, taupe
Chemin de table taupe
Runner taubegrau
Camino de mesa gris topo

70% Pvc - 30% Pet

	cm	in
AVARI TO 32	45x120	17,3/4x47,2

**Runner - grigio sabbia**

Runner, sand
Chemin de table sable
Runner sandgrau
Camino de mesa arena

70% Pvc - 30% Pet

	cm	in
AVARI TO 33	45x120	17,3/4x47,2

**Runner - grigio marrone con rettangolo**

Runner, brown with rectangle
Chemin de table marron avec rectangle
Runner braungrau rechteckig
Camino de mesa marrón con rectángulo

70% Pvc - 30% Pet

	cm	in
AVARI TO 34	45x120	17,3/4x47,2



Tovaglietta marrone con rettangolo

Placemat, brown with rectangle
 Nappe individuelle marron avec rectangle
 Mantel individual marrón con rectángulo
 Tischset braun mit Rechteck

70% Pvc - 30% Pet

	cm	in
AVARITO 10	45x30	17,3/4x11,3/4

**Tovaglietta sabbia/tortora a quadri**

Placemat, sand/taupe with squares
 Nappe individuelle sable/taupe avec carrés
 Mantel individual arena/gris topo de cuadrados
 Tischset sand/Taube mit Quadraten

70% Pvc - 30% Pet

	cm	in
AVARITO 12	45x30	17,3/4x11,3/4

**Tovaglietta marrone a quadri**

Placemat brown squares
 Nappe individuelle marron carrés
 Klein Tischtuch braun mit Quadrat
 Mantel individual marrón cuadrados

70% Pvc - 30% Pet

	cm	in
AVARITO 12	45x30	17,3/4x11,3/4

**Tovaglietta bianca 2 fasce laterali**

Placemat, white with 2 side stripes
 Nappe individuelle blanche avec 2 bandes laterales
 Mantel individual blanco con 2 bandas laterales
 Tischset weiß mit 2 Seitenstreifen

70% Pvc - 30% Pet

	cm	in
AVARITO 13	45x30	17,3/4x11,3/4

**Tovaglietta riquadri**

Placemat squares
 Nappe individuelle carrés
 Klein Tischtuch mit Quadrat
 Mantel individual cuadrados

70% Pvc - 30% Pet

	cm	in
AVARITO 50	45x30	17,3/4x11,3/4

**Tovaglietta marrone 2 fasce laterali**

Placemat, brown with 2 side stripes
 Nappe individuelle marron avec 2 bandes laterales
 Mantel individual marrón con 2 bandas laterales
 Tischset braun mit 2 Seitenstreifen

70% Pvc - 30% Pet

	cm	in
AVARITO 14	45x30	17,3/4x11,3/4

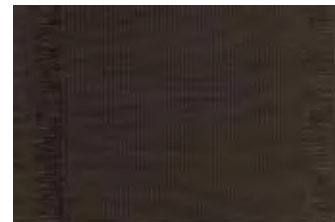

Tovaglietta - grigio scuro

Placemat - dark grey
 Nappe individuelle gris fouché
 Klein Tischtuch dunkel grau
 Mantel individual gris oscuro

70% Pvc - 30% Pet

	cm	in
AVARITO 01	45x30	17,3/4x11,3/4

**Tovaglietta - grigio chiaro**

Placemat- light grey
 Nappe individuelle gris clair
 Klein Tischtuch hellgrau
 Mantel individual gris claro

70% Pvc - 30% Pet

	cm	in
AVARITO 02	45x30	17,3/4x11,3/4

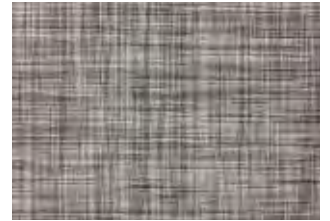
**Tovaglietta - tortora**

Placemat - taupe
 Nappe individuelle taupe
 Klein Tischtuch grau
 Mantel individual gris topo

70% Pvc - 30% Pet

	cm	in
AVARITO 03	45x30	17,3/4x11,3/4

**Tovaglietta beige/marrone/riga azzurra**

Placemat, beige/brown/blue stripe
 Nappe individuelle beige/bleue/marron
 Klein Tischtuch beige/hellblau/braun
 Mantel individual beige/azul claro/marrón

70% Pvc - 30% Pet

	cm	in
AVARITO 05	45x30	17,3/4x11,3/4

**Tovaglietta - sabbia**

Placemat - sand
 Nappe individuelle sable
 Klein Tischtuch sand
 Mantel individual arena

70% Pvc - 30% Pet

	cm	in
AVARITO 07	45x30	17,3/4x11,3/4

**Tovaglietta - marrone lavorato**

Placemat - light brown - woven
 Nappe individuelle marron tressée
 Klein Tischtuch braun, gearbeitet
 Mantel individual marrón tejido

70% Pvc - 30% Pet

	cm	in
AVARITO 08	45x30	17,3/4x11,3/4



Tovaglietta bamboo marrone chiaro

Placemat, bamboo light brown
 Nappe individuelle bamboo marron clair
 Mantel individual bambú marrón claro
 Tischset bambus, hellbraun

Bamboo

	cm	in
AVARI TO 40	45x30	17,3/4x11,3/4

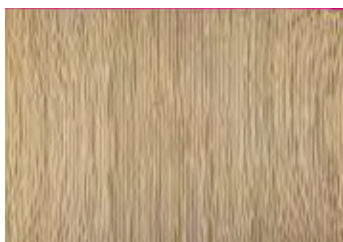
**Tovaglietta bamboo marrone scuro**

Placemat, bamboo dark brown
 Nappe individuelle bamboo marron foncé
 Mantel individual bambú marrón oscuro
 Tischset bambus, dunkelbraun

Bamboo

	cm	in
AVARI TO 41	45x30	17,3/4x11,3/4

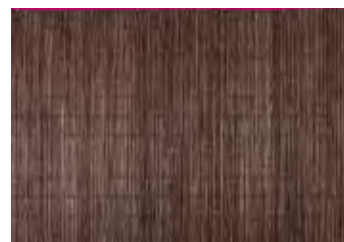
**Tovaglietta intrecciata nera**

Placemat, woven black
 Nappe individuelle tressée noire
 Mantel individual trenzado negro
 Tischset schwarz gewebt

70% Pvc - 30% Pet

	cm	in
AVARI TO 61	45x30	17,3/4x11,3/4

**Tovaglietta intrecciata grigia**

Placemat, woven grey
 Nappe individuelle tressée grise
 Mantel individual trenzado gris
 Tischset grau gewebt

70% Pvc - 30% Pet

	cm	in
AVARI TO 60	45x30	17,3/4x11,3/4

**Tovaglietta intrecciata beige**

Placemat, woven sand
 Nappe individuelle tressée beige
 Mantel individual trenzado beige
 Tischset sand gewebt

70% Pvc - 30% Pet

	cm	in
AVARI TO 63	45x30	17,3/4x11,3/4

**Tovaglietta intrecciata marrone**

Placemat, woven brown
 Nappe individuelle tressée marron
 Mantel individual trenzado marrón
 Tischset braun gewebt

70% Pvc - 30% Pet

	cm	in
AVARI TO 62	45x30	17,3/4x11,3/4



Set 4 tovagliette grigio chiaro

4-pc set placemat, light grey
 Set 4 nappes individuelles gris clair
 Set 4 manteles individuales gris claro
 4er Tischset, hellgrau

70% Pvc - 30% Pet

	cm	in
AVARI TO 02 S4	45x30	17,3/4x11,3/4

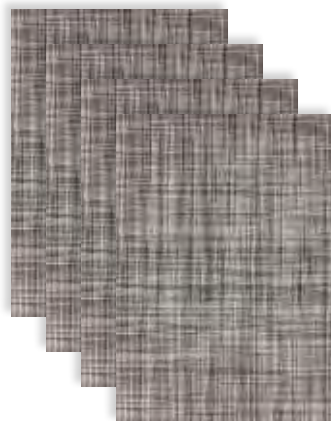
**Set 4 tovagliette tortora**

4-pc set placemat, taupe
 Set 4 nappes individuelles taupe
 Set 4 manteles individuales gris topo
 4er Tischset, taube

70% Pvc - 30% Pet

	cm	in
AVARI TO 03 S4	45x30	17,3/4x11,3/4

**Set 4 tovagliette sabbia**

4-pc set placemat, sand
 Set 4 nappes individuelles sable
 Set 4 manteles individuales arena
 4er Tischset, sand

70% Pvc - 30% Pet

	cm	in
AVARI TO 07 S4	45x30	17,3/4x11,3/4

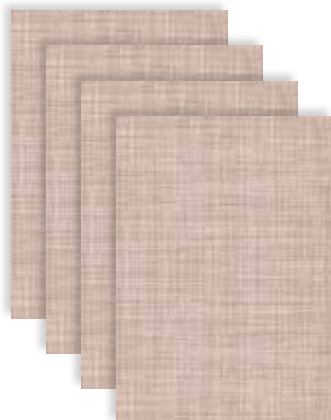
**Box 12 set 4 pz tovagliette**

Box 12 set 4-pc set placemat
 Boîte 12 sets 4 pcs nappes individuelles
 Caja 12 sets 4 pzs nappes individuelles
 Box 12, 4-teiliges Tischset

AVARI TO 9B 01

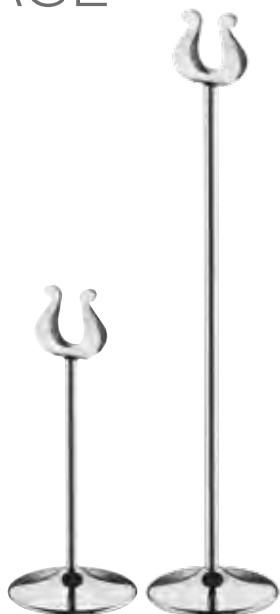

Segnatavolo a colonna (portanumero)

Table number stand, column-shaped
Support numéro de table à colonne
Tischnummerständer
Número sobremesa a columna

Acciaio Inox 18/10 - St. Steel 18/10

	H cm	H in
V01 05 19 019	19	7,1/2
V01 05 19 046	45	17,3/4



Cavalletto portaetichetta per buffet (senza tavoletta - without black tag)

Buffet easel for tags
Chevalet porte-nom pour buffet
Aufsteller Produktinfo
Soporte caballete para etiqueta para buffet

Inox 18/10 - St. Steel

	H cm	H in
V01 05 19 001	14,5	5,3/4

Tavoletta nera per cavalletto

Black tag for easel
Plaque pour chevalet noir
Schild für Produktinfo
Etiqueta negra para soporte caballete

Plexiglass

	H cm	H in
V01 12 19 001	10x7,5	4x3



Portatoast in filo

Toast holder, steel wire
Porte-toasts en fil
Toastständer
Portatostadas en hilo

Acciaio Inox 18/10 - St. Steel 18/10

	cm	H cm	in	H in
V01 05 71 195	19,5	15	7,5/8	6

Formaggiara Imperial

Imperial grated-cheese holder
 Ravier à parmesan Imperial
 Käsedose Imperial
 Quesera Imperial

Acciaio Inox 18/10 - St. Steel 18/10

	Cm	H cm	In	H in
V01 05 13 001	15,5x12,5	8	6,1/8x4,7/8	3,1/8



Oliera 4 pezzi Imperial

Imperial oil & vinagar cruet set, 4-piece
 Ménagère Imperial, 4 pièces
 Menage, 4-tlg Imperial
 Servicio de mesa Imperial, 4 piezas

Acciaio Inox 18/10 - St. Steel 18/10

	Cm	H cm	In	H in
V01 05 11 005	16,5x13,5	23	6,1/2x5,3/8	9



Oliera 2 pezzi Imperial

Imperial oil & vinagar cruet set, 2-piece
 Ménagère Imperial, 2 pièces
 Menage, 2-tlg Imperial
 Servicio de mesa Imperial, 2 piezas

Acciaio Inox 18/10 - St. Steel 18/10

V01 05 11 002



Tris sale, pepe e stecchi Imperial

Imperial salt and pepper shakers and toothpick holder
 Salière, poivrière et porte cure-dents Imperial
 Salz/Pfefferstreüer und Zahnstocherträger Imperial, 3-tlg
 Salero, pimentero y palillero Imperial

Acciaio Inox 18/10 - St. Steel 18/10

	Ø cm	H cm	Ø in	H in
V01 05 12 003	12,5	16,5	4,7/8	6,1/2



Spargi sale/pepe singolo Imperial

Imperial salt/pepper shaker
 Salière/poivrière individuelle Imperial
 Salz/Pfefferstreüer Imperial
 Salero/pimentero individual Imperial

Acciaio Inox 18/10 - St. Steel 18/10

	Ø cm	H cm	Ø in	H in
V01 05 12 001	3,5	9	1,3/8	3,1/2



Formaggiara 2000

2000 Cheese bowl

Fromagère 2000

Käsedose 2000

Quesera 2000

Acciaio Inox - St. Steel

	Cm	H cm	In	H in
V61 05 13 001	13x9	7,5	5,1/8x3,1/2	3

**Oliera 5 pezzi Menage**

Menage oil & vinegar cruet set, 5-piece

Ménagère Menage, 5 pièces

Menage, 5-tlg

Servicio de mesa Menage, 5 piezas

Acciaio Inox - St. Steel

	Cm	H cm	In	H in
V12 06 11 005	15x11,5	22	5,7/8x 4,1/2	8,5/8

**Tris sale, pepe e stecchi Inox**

Salt and pepper shakers and toothpick holder, plain

Salière, poivrière et porte cure-dents simples

Salz/Pfefferstreuer mit Zahnstochträger, Edelstahl

Tris salero, pimentero y palillero Inox

Acciaio Inox - St. Steel

	Cm	H cm	In	H in
V12 06 12 003	8,5x7,5	14,5	3,3/8x3	5,3/4

**Cestino porta salse 4 Pezzi**

Sauce-jar holder, 4-pc

Porte-sauces 4 pcs

Soßenkorb 4pz

Porta salsas 4 pzs

Acciaio Inox 18/10 - St. Steel 18/10

	Ø Cm	H. Cm	Ø In	H. In
AVARI231	16	25	6,1/4	9,7/8



Oliera 2 pezzi Victory

Victory oil & vinegar cruet set, 2-piece
 Ménagère Victory, 2 pièces
 Essig/Ölgestell 2-tlg Victory
 Servicio de mesa Victory, 2 piezas

Acciaio Inox 18/10 - St. Steel 18/10

	Cm	H cm	In	H in
V52 05 11 002	14,5x10,5	20	5,3/4x4,1/8	7,7/8



Tris sale, pepe e stecchi Victory

Victory salt and pepper shakers and toothpick holder
 Salière, poivrière et porte cure-dents Victory
 Salz/Pfeffersteuer mit Zahnstocherträger, 3-tlg Victory
 Salero, pimentero y palillero Victory

Acciaio Inox 18/10 - St. Steel 18/10

V52 05 12 003



Formaggiera Victory

Victory grated-cheese holder
 Ravier à parmesan Victory
 Käsedose Victory
 Quesera Victory

Acciaio Inox 18/10 - St. Steel 18/10

	Cm	H cm	In	H in
V52 05 13 001	16x12,5	9	6,1/4x4,7/8	3,1/2



Oliera 5 pezzi Victory

Victory oil & vinegar cruet set, 5-piece
 Ménagère Victory, 5 pièces
 Essig/Ölgestell 5-tlg Victory
 Servicio de mesa Victory, 5 piezas

Acciaio Inox 18/10 - St. Steel 18/10

	Cm	H cm	In	H in
V52 05 11 005	15x13	20	5,7/8x5,1/8	7,7/8



Sale/pepe Square

Glass cruet salt spreader Square

Verre pour salière Square

Salzstreuer mit

Vidrio salero Square

Acciaio Inox - St. Steel

	cm	in	H cm	H in
V76 05 12 002	9,5x4,5	3,3/4x1,3/4	12,5	5

**Oliera 2 pz olio/aceto Square**

Glass cruet oil/vinegar set Square

Burette huile/vinaigre Square

Essig/Ölglas flaschen mit

Alcuza aceite/vinagre Square

Acciaio Inox - St. Steel

	cm	in	H cm	H in
V76 05 11 002	12,5x5,5	5x2,1/8	20	7,7/8

**Formaggiera Square**

Cheese bowl Square

Ravier a parmesan Square

Käsedose Square

Quesera Square

Acciaio Inox - St. Steel

	cm	in	H cm	H in
V76 05 13 001	8,5x9	3,3/8x3,1/2	8,5	3,3/8



Portabottiglie olio/aceto con spargisale/pepe

Oil and vinegar bottle rack with salt and pepper shakers
 Porte bouteilles huile-vinaigre, salière, poivrière
 Essig/Ölflaschenträger, Salz/Pfeffersteuer
 Portabotellas aceite y vinagre, salero, pimentero

Acciaio Inox - St. Steel

	Cl	Oz	cm
AVARI 060 A	25	9	12x5,5x25
AVARI 061 A	50	17,5	14x7x81



Portabottiglie olio/aceto

Oil and vinegar bottle rack
 Porte bouteilles huile-vinaigre
 Essig/Ölflaschenträger
 Portabotellas aceite y vinagre

Acciaio Inox - St. Steel

	Cl	Oz	cm
AVARI 060	25	9	12x6,5x25
AVARI 061	50	17,5	14,5x7,5x32



Oliera

Oil dispenser
 Huilière
 Ölbehälter
 Aceitera grande

Acciaio Inox - St. Steel

	lt	Oz
AVARI 071	0,5	17,5
AVARI 072	1,0	35



Oliera con tappo versatore salvagoccia

Oil server with drop stop pourer
 Huilier avec bouchon verseur anti-gouttes
 Olivenölbehälter mit Eingießstößel, mit Tropfschutzverschluss
 Aceitera con tapón vertedor antigoteo

Acciaio Inox 18/10 - St. Steel 18/10

	lt	Oz
AVARI 400	0,25	9
AVARI 401	0,50	17,5
AVARI 402	0,75	26,5
AVARI 403	1,00	35



Oliera Pasha

Pasha oil & vinegar cruet set
Ménagère Pasha
Menage Pasha
Servicio de mesa Pasha

- V02 12 11 004 07
- V02 12 11 004 12
- V02 12 11 004 13
- V02 12 11 004 34
- V02 12 11 004 47

**Oliera Jolly**

Jolly oil & vinegar cruet set
Ménagère Jolly
Menage Jolly
Servicio de mesa Jolly

- V10 12 11 004 41
- V10 12 11 004 34
- V10 12 11 004 43
- V10 12 11 004 38
- V10 12 11 004 40
- V10 12 11 004 47

**Formaggiera Pasha con vaso vetro**

Pasha grated-cheese holder
Ravier à parmesan Pasha
Käsedose Pasha
Quesera Pasha

PP+PS

- V02 12 13 001 07
- V02 12 13 001 12
- V02 12 13 001 13
- V02 12 13 001 34
- V02 12 13 001 47

**Formaggiera Jolly**

Jolly grated-cheese holder
Ravier à parmesan Jolly
Käsedose Jolly
Quesera Jolly

PP+PS

- V10 12 13 001 41
- V10 12 13 001 34
- V10 12 13 001 43
- V10 12 13 001 38
- V10 12 13 001 40
- V10 12 13 001 47



Ricambi Imperial/Victory

Imperial/Victory spare parts
Pièces de rechange Imperial/Victory
Imperial/Victory Ersatzteilen
Repuestos Imperial/Victory

AR33 TAPPO OLIERA CON SALVAGOCCIA / DROP STOP CAP OIL CRUETS

AR31 CAPSULA SALINO / CAP SALT SHAKER

AR32 CAPSULA STECCHI / CAP TOOTHPICK HOLDERS



AR31



AR32

Ricambi Cronos

Cronos spare parts
Pièces de rechange Cronos
Cronos Ersatzteilen
Repuestos Cronos

AR8 TAPPO OLIERA CON SALVAGOCCIA / DROP STOP CAP OIL CRUETS

AR12 CAPSULA SALE E PEPE / CAP FOR SALT AND PEPPER

AR25 CAPSULA STECCHI / CAP FOR TOOTHPICK



AR8



AR12



AR25

Ampolla vetro oliera Cronos/Imperial/Victory

Glass cruet for Cronos/Imperial/Victory cruet sets
Bouchon anti-goutte pour huilier Imperial/Victory
Glas Ersatzteil für Öl-und Essigset
Tapón antigoteo para aceitera Imperial/Victory

	ø cm	H cm	ø in	H in
AR3	5	13,5	2	5,3/8



Vetro formaggiiera Cronos/Imperial/Pasha/Jolly

Glass bowl for Cronos/Imperial/Pasha/Jolly
Bol en verre pour ravier à parmesan Cronos/Imperial/Pasha/Jolly
Glas Ersatzteil für Käsedose Cronos/Imperial/Pasha/Jolly
Bol de vidrio para Cronos/Imperial/Pasha/Jolly

	ø cm	H cm	ø in	H in
AR14	9	4,9	3,1/2	2



Vetro salino Mondial/Cronos/Imperial/Pasha/Jolly/Menage/Dribbly

Glass bowl for Mondial/Cronos/Imperial/Pasha/Jolly/Menage/Dribbly salt/pepper shakers
Bouteille verre pour salière Mondial/Cronos/Imperial/Pasha/Jolly/Menage/Dribbly
Glas Ersatzteil für Salz und Pfefferstreuer
Botellita de vidrio para salino Mondial/Cronos/Imperial/Pasha/Jolly/Menage/Dribbly shakers

	ø cm	H cm	ø in	H in
AR4	3-5	8	1,3/8	3,1/8



Vassoio tondo bar

Round bar tray
Plateau rond bar
Austellplatte, rund
Bandeja redonda bar

Acciaio Inox 18/10 - St. Steel 18/10

	ø cm	ø in
V01 05 23 T32	32	12,5/8
V01 05 23 T38	38	15
V01 05 23 T46	46	18,1/8
V01 05 23 T54	54	21,1/4

**Vassoio tondo bar con maniglie**

Round bar tray with handles
Plateau rond bar avec poignées
Austellplatte mit Griffen, rund
Bandeja redonda bar con asas

Acciaio Inox 18/10 - St. Steel 18/10

	ø cm	ø in
V01 05 23 T32M	32	12,5/8
V01 05 23 T38M	38	15
V01 05 23 T46M	46	18,1/8
V01 05 23 T54M	54	21,1/4

**Vassoio tondo con bordo Basic**

Round tray Basic
Plateau rond Basic
Austellplatte, rund Basic
Bandeja redonda Basic

Acciaio Inox 18/10 - St. Steel 18/10

	ø cm est.	ø cm int.	ø in ext.	ø in int.
V01 05 23 TB31	31	27	12,1/4	10,5/8
V01 05 23 TB36	36	30	14,1/8	11,3/4
V01 05 23 TB41	41	35	16,1/8	13,3/4

**Vassoio birra**

Beer tray
Plateau à bière
Bierplatte
Bandeja para cerveza

Acciaio Inox 18/10 - St. Steel 18/10

	ø cm	ø in
CI 5411	30	11,3/4
CI 5412	40	15,3/4



Vassoio rettangolare gastronorm

Gastronorm tray, rectangular
 Plateau rectangulaire Gastronorm
 Austellplatte, rechteckig, Gastronorm
 Bandeja rectangular Gastronorm

Acciaio Inox 18/10 - St. Steel 18/10

	cm	in
V01 05 23 G12	26,5x32,5	10,3/8x12,3/4
V01 05 23 G11	53x32,5	20,7/8x12,3/4
V01 05 23 G21	65x53	25,5/8x20,7/8

**Vassoio rettangolare gastronorm con maniglie**

Gastronorm tray with handles, rectangular
 Plateau rectangulaire Gastronorm avec poignées
 Austellplatte mit Griffen, rechteckig, Gastronorm
 Bandeja rectangular Gastronorm con asas

Acciaio Inox 18/10 - St. Steel 18/10

	cm	in
V01 05 23 G12M	32,5x26,5	12,3/4x10,3/8
V01 05 23 G11M	53x32,5	20,7/8x12,3/4
V01 05 23 G21M	65x53	25,5/8x20,7/8

**Vassoio rettangolare Basic**

Gastronorm tray, rectangular
 Plateau rectangulaire Gastronorm
 Austellplatte, rechteckig, Gastronorm
 Bandeja rectangular Gastronorm

Acciaio Inox 18/10 - St. Steel 18/10

	cm	in
V01 05 23 GB12	26,5x32,5	10,3/8x12,3/4
V01 05 23 GB11	53x32,5	20,7/8x12,3/4
V01 05 23 GB21	65x53	25,5/8x20,7/8

**Vassoio gratin ovale**

Gratin tray
 Plat gratin ovale
 Ovale Gratinplatte
 Plato gratin oval

Acciaio Inox 18/10 - St. Steel 18/10

	cm	in
CI 24501	28x17	11x6,3/4



Vassoio rettangolare bar con bordo

Bar tray with edge, rectangular
 Plateau rectangulaire bar avec rebord
 Austellplatte, rechteckig
 Bandeja rectangular bar con borde

Acciaio Inox 18/10 - St. Steel 18/10

	cm	in	Sp. mm
V01 05 23 R30	30x24	11,3/4x9,1/2	0,8
V01 05 23 R35	35x29	13,3/4x11,1/2	0,8
V01 05 23 R40	40x31	15,3/4x12,1/4	1,0
V01 05 23 R45	45x34	17,3/4x13,3/8	1,0
V01 05 23 R52	52x40	20,1/2x15,3/4	1,0
V01 05 23 R62	62x48	24,3/8x19	1,0

**Vassoio rettangolare bar senza bordo**

Bar tray without edge, rectangular
 Plateau rectangulaire bar sans rebord
 Austellplatte rechteckig
 Bandeja rectangular bar sin borde

Acciaio Inox 18/10 - St. Steel 18/10

	cm	in	Sp. mm
V03 05 23 R27	27x21	10,5/8x8,1/4	0,8
V03 05 23 R30	30x24	11,3/4x9,1/2	0,8
V03 05 23 R35	35x28	13,3/4x11	0,8
V03 05 23 R40	40x32	15,3/4x12,5/8	1,0
V03 05 23 R45	45x35	17,3/4x13,3/4	1,0
V03 05 23 R50	50x38	19,3/4x15	1,0

**Vassoio rettangolare bar senza bordo**

Bar tray without edge, rectangular
 Plateau rectangulaire bar sans rebord
 Austellplatte rechteckig
 Bandeja rectangular bar sin borde

Acciaio Inox - St. Steel

	cm	in	Sp. mm
V03 06 23 R27	27x21	10,5/8x8,1/4	0,8
V03 06 23 R31	30x24	11,3/4x9,1/2	0,8
V03 06 23 R36	35x28	13,3/4x11	0,8
V03 06 23 R40	40x32	15,3/4x12,5/8	1,0
V03 06 23 R45	45x35	17,3/4x13,3/4	1,0
V03 06 23 R50	50x38	19,3/4x15	1,0



Piatto portata ovale con bordo Easy

Easy plate with edge, oval
Assiette ovale Easy avec rebord
Oval Tablett "Easy" mit Rand
Fuente oval Easy con borde

Acciaio Inox - St. Steel

	cm	in
V65 05 23 020	20X11	7,7/8x4,3/8
V65 05 23 025	25x17	9,7/8x6,3/4
V65 05 23 030	30x21	11,3/4x8,1/4
V65 05 23 035	35x24	13,3/4x9,1/2
V65 05 23 040	40x27	15,3/4x10,5/8
V65 05 23 045	45x30	17,3/4x11,3/4
V65 05 23 050	50x33	19,3/4x13
V65 05 23 059	59X40	23,1/4x15,3/4

**Piatto ovale senza bordo**

Plate without edge, oval
Assiette ovale sans rebord
Bratenplatte, oval
Fuente oval sin borde

Acciaio Inox 18/10 - St. Steel 18/10

	cm	in
V03 05 22 025	25x17	9,7/8x6,3/4
V03 05 22 030	30x21	11,3/4x8,1/4
V03 05 22 035	35x24	13,3/4x9,1/2
V03 05 22 040	40x27	15,3/4x10,5/8
V03 05 22 045	45x31	17,3/4x12,1/4
V03 05 22 050	50x35	19,3/4x13,3/4

**Piatto portata tondo con bordo**

Plate with edge, round
Assiette ronde avec rebord
Bratenplatte, rund mit Rand
Fuente redonda con borde

Acciaio Inox 18/10 - St. Steel 18/10

	ø cm est.	ø cm int.	ø in ext.	ø in int.
V01 05 22 T29	29	20	11,1/2	7,7/8
V01 05 22 T34	34	24	13,3/8	9,1/2
V01 05 22 T38	38	26	15	10,1/4

**Piatto portata pesce**

Fish plate
Assiette à poisson
Fischplatte
Fuente para pescado

Acciaio Inox - St. Steel

	cm	in
V01 05 22 P60	60x24,5	23,5/8x9,5/8
V01 05 22 P70	70x28,5	27,1/2x11,1/4



**Piatto portata ovale con bordo/pes**

Oval platter with rim
 Plateau oval bordé
 Fuente oval con borde
 Bratenplatte, oval

Acciaio inox 18/10 - St. steel 18/10

	cm
V010522025	25x17

Piatto portata ovale con bordo/pes

Oval platter with rim
 Plateau oval bordé
 Fuente oval con borde
 Bratenplatte, oval

Acciaio inox 18/10 - St. steel 18/10

	cm
V010522029	30x21

Piatto portata ovale con bordo/pes

Oval platter with rim
 Plateau oval bordé
 Fuente oval con borde
 Bratenplatte, oval

Acciaio inox 18/10 - St. steel 18/10

	cm
V010522044	45x33

Piatto portata ovale con bordo/pes

Oval platter with rim
 Plateau oval bordé
 Fuente oval con borde
 Bratenplatte, oval

Acciaio inox 18/10 - St. steel 18/10

	cm
V010522049	50x33

Piatto portata ovale con bordo/pes

Oval platter with rim
 Plateau oval bordé
 Fuente oval con borde
 Bratenplatte, oval

Acciaio inox 18/10 - St. steel 18/10

	cm
V010522034	35x24

Piatto portata ovale con bordo/pes

Oval platter with rim
 Plateau oval bordé
 Fuente oval con borde
 Bratenplatte, oval

Acciaio inox 18/10 - St. steel 18/10

	cm
V010522038	40x27

Piatto portata ovale con bordo/pes

Oval platter with rim
 Plateau oval bordé
 Fuente oval con borde
 Bratenplatte, oval

Acciaio inox 18/10 - St. steel 18/10

	cm
V010522059	

Vassoio sovrapponibile gastronomo rettangolare (1 pz - 1 pc)

Stackable gastronorm rectangular tray

Plateau empilable gastronorme rectangulaire avec poignées

Gastronorm Tablett - rund und stapelbar

Bandeja rectangular gastronorm apilable

Acciaio Inox 18/10 - St. Steel 18/10

	cm	in
V01 05 23 G11S	53x32,5	20,7/8x12,3/4
V01 05 23 G21S	65x53	25,5/8x20,7/8

**Vassoio sovrapponibile gastronomo tondo (1 pz - 1 pc)**

Stackable gastronorm round tray

Plateau empilable rond avec poignées

Tablett-rund und stapelbar

Bandeja redonda gastronorm apilable

Acciaio Inox 18/10 - St. Steel 18/10

	∅ cm	∅ in
V01 05 23 T46S	46	18,1/8
V01 05 23 T54S	54	21,1/4



**Vassoio da banco/bar pasticceria**

Bar/pastry tray
Plateau bar/pâtisserie
Konditoreiplatte
Bandeja bar/pastelería

Acciaio inox 18/10 - St. steel 18/10

Vassoi adatti a banchi di pasticceria, bar e gastronomia con angolo parete chiuso. Facili da pulire ed igienici.

Trays for pastry, bar & gastronomy counters with closed corners. hygienic and Easy to clean.



	Cm	H. Cm	In	H. In
V01 05 23 P06	35x10 sp	H.0,8	13.3/4x4	0,31



	Cm	H. Cm	In	H. In
V01 05 23 P01	50x10 sp	H.0,8	19,3/4x4	0,31



	Cm	H. Cm	In	H. In
V01 05 23 P02	60x10 sp	H.0,8	23.5/8x4	0,31



	Cm	H. Cm	In	H. In
V01 05 23 P07	25x20 sp	H.0,8	9.7/8x7.7/8	0,31



	Cm	H. Cm	In	H. In
V01 05 23 P08	35x20 sp	H.0,8	13.3/4x7.7/8	0,31



	Cm	H. Cm	In	H. In
V01 05 23 P03	50x20 sp	H.0,8	19.3/4x7.7/8	0,31



	Cm	H. Cm	In	H. In
V01 05 23 P04	60x20 sp	H.0,8	23.5/8x7.7/8	0,31



	Cm	H. Cm	In	H. In
V01 05 23 P05	70x20 sp	H.0,8	27.1/2x7.7/8	0,31



Celsius è il nuovo piatto che mantiene costante la temperatura delle pietanze senza continuare il processo di cottura, per conservare al meglio il gusto di ogni ricetta.

Design moderno ed essenziale, che si abbina a ogni mise en place e innovativa funzionalità grazie alla presa ergonomica della base in legno, che protegge dalle scottature.

La piastra in alluminio viene **riscaldato in forno**, regolando temperatura e tempo a seconda della pietanza, per poi essere posizionata sotto il piatto in acciaio che, a contatto con gli alimenti, **mantiene costante la temperatura** del cibo durante il pasto.

Celsius è un prodotto **igienico e di facile pulizia**: il piatto in acciaio (unica componente a contatto con gli alimenti) è comodamente lavabile in lavastoviglie, a differenza delle pietre ollari che assorbono i grassi, non sono lavabili e alterano lo stato di cottura delle pietanze.

Celsius è disponibile in quattro versioni per rispondere a ogni esigenza, dal singolo posto tavola ai momenti di convivialità, e in due forme adatte a diverse tipologie di pietanze come ad esempio le carni e la pizza.

Celsius. Per non servire più cibi freddi!

Celsius is the new plate that keeps food temperature constant without continuing the cooking process, to best preserve the taste of every recipe.

Modern and essential design, matching with every place setting, and innovative functionality, thanks to the ergonomic grip, and the wood base, that protects from burning.

The aluminum plate is **warmed into the oven**, adjusting temperature and time based on the food; then it is placed under the steel plate that, in contact with food, **keeps its temperature constant** during the meal.

Celsius is a healthy product and **easy to clean**: the steel plate (the only component in contact with food) is dishwasher safe while, for instance, soapstone, that absorbs fat, is not washable and alters food cooking.

Celsius comes in four versions to meet every need, from the individual place setting to the large gatherings, and in two different shapes, suitable for different foods, like meat and pizza.

Celsius. You will not serve cold food anymore!



Celsius

IDEALE PER SERVIRE
PERFECT TO SERVE



CARNE
MEAT



PESCE
FISH



VERDURE
VEGETABLES



PIZZA E NON SOLO
PIZZA & MORE

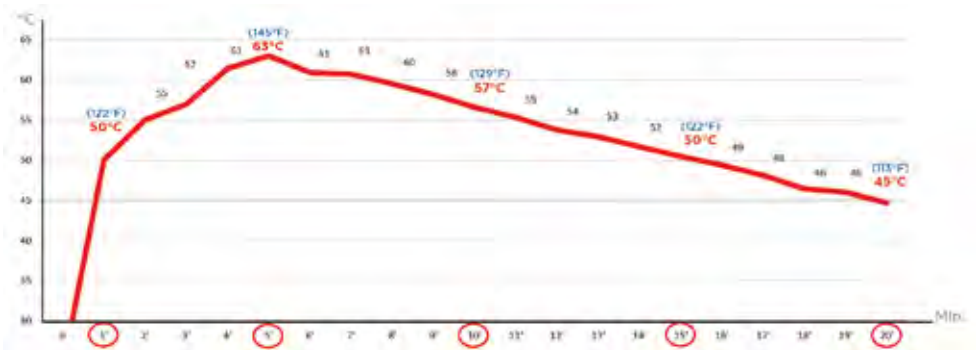

Vassoio grill rettangolare

Rectangular grill tray
 Plateau grill rectangulaire
 Grilltablett rechteckig
 Bandeja grill rectangular

	cm	in
V89 05 22 R01	29x20	11,1/2x7,7/8
V89 05 22 R02	34x24	13,3/8x9,1/2

**Piatto**

Plate
 Plat
 Edelstahl Tablett rechteckig
 Plato

Acciaio Inox 18/10 - St. Steel 18/10

	cm	in
Z89 14 22 R01	29x20	9,7/8x7,1/4
Z89 14 22 R02	34x24	11,5/8x8,1/2

**Piastra alluminio**

Aluminum plate
 Plaque aluminium
 Aluminiumplatte
 Placa aluminium

Alluminio - Aluminum

	cm	in
Z89 15 22 R01	19x12	7,1/2x4,3/4
Z89 15 22 R02	24x15,5	9,1/2x6,1/8

**Base rettangolare**

Rectangular base
 Base rectangulaire
 Holzgestell rechteckig
 Base rectangular

Legno di betulla - Birch wood

	cm	in
Z89 19 22 R01	29x20	11,1/2x7,7/8
Z89 19 22 R02	34x24	13,3/8x9,1/2

Vassoio grill ovale

Oval grill tray
Plateau grill oval
Grilltablett oval
Bandeja grill oval

	cm	in
V89 05 22 T01	28x32	1x12,5/8
V89 05 22 T02	38x34	15x13,3/8



Piatto

Plate
Plat
Edelstahl Tablett oval
Plato

Acciaio Inox 18/10 - St. Steel 18/10

	ø cm	ø in
Z89 14 22 T01	25,5	10
Z89 14 22 T02	31,5	12,3/8



Piastra alluminio

Aluminum plate
Plaque aluminium
Aluminiumplatte
Placa aluminium

Alluminio - Aluminum

	ø cm	ø in
Z89 15 22 T01	20	7,7/8
Z89 15 22 T02	24	9,1/2



Base ovale

Oval base
Base ovale
Holzgestell oval
Base oval

Legno di betulla - Birch wood

	cm	in
Z89 19 22 T01	28x32	1x12,5/8
Z89 19 22 T02	38x34	15x13,3/8



Piatto refrigerato

Dish, refrigerated
 Plat réfrigéré
 Servierplatte, gekühlt
 Fuente refrigerada

Acciaio inox 18/10 - St. steel 18/10

	Ø Cm	H. Cm	Ø In	H. In
CI 22 600R	32	3,5	12,5/8	1,3/8

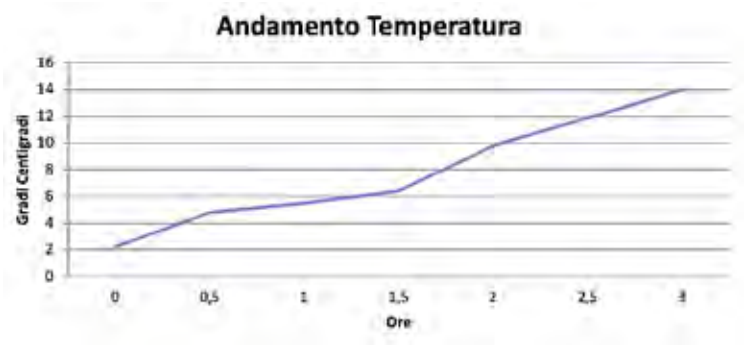

Piatto non refrigerato

Dish, non-refrigerated
 Plat pas réfrigéré
 Servierplatte, nicht gekühlt
 Fuente no refrigerada

Acciaio inox 18/10 - St. steel 18/10

	Ø Cm	H. Cm	Ø In	H. In
CI 22 600	32	3,5	12,5	1,3/8







WINE ● BAR

Glacette doppio corpo

Double wall bottle cooler
 Rafrâchisseur à bouteille/vin double paroi
 Weinkühler, doppelwandig
 Enfriador de botella doble pared

Acciaio Inox 18/10 - St. Steel 18/10

	ø cm	ø in	H cm	H in
V78 05 24 014	13	5,1/8	21	8,1/4

**Secchio champagne per 2/3 bottiglie**

Champagne cooler for 2/3 bottles
 Seau à champagne pour 2/3 bouteilles
 2/3 Flaschen Champagnekühler
 Cubo champán para 2/3 botellas

Acciaio Inox 18/10 - St. Steel 18/10

	ø cm	ø in	H cm	H in
V78 05 20 022	22	8,5/8	21	8,1/4

**Supporto secchio spumante linea Wine&Bar**

Wine&Bar champagne cooler stand
 Support pour seau à champagne Wine&Bar
 Wine&Bar Champagnekühler Ständer
 Soporte para cubo champán Wine&Bar

Acciaio Inox 18/10 - St. Steel 18/10

	ø cm	ø in	H cm	H in
V78 05 20 675	23	9	58	22,7/8

Shaker

Cocktail shaker
Shaker
Cocktail Shaker
Coctelera

Acciaio Inox 18/10 - St. Steel 18/10

	lt	Oz
V78 05 81 SHA	0,7	17



Bicchieri Boston

Boston mixing container
Verre en métal pour Boston
Boston Metallbecher
Vaso en metal para Boston

Acciaio Inox 18/10 - St. Steel 18/10

Vetro - Glass

	lt	ø cm	H cm	
V78 05 81 SHA 2B 0,7	9	17	6,3/4	acciaio
V78 08 81 SHA 2B 0,7	9	17	6,3/4	vetro



Secchiello ghiaccio doppio corpo

Double wall ice bucket
Seau à glace double paroi
Eiswürfelbehälter, doppelwandig
Cubo hielo doble pared

Acciaio Inox 18/10 - St. Steel 18/10

	ø cm	ø in	H cm	H in
V78 05 20 014	13	5,1/8	18	7,1/8



Scoladecanter

Decanter wine stand
Egouttoir de carafe
Karaffentrockner
Soporte para decantador

Acciaio Inox - St. Steel

	H cm	H in
V01 05 24 020	30	11,3/4

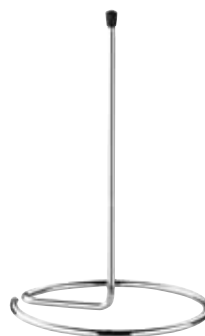

Versavino

Red wine holder
Porte-bouteille
Portabotella
Rotweinwiege

Acciaio Inox 18/10 - St. Steel 18/10

	cm	in
V01 05 24 022	30	11,3/4



Secchio ghiaccio Modern

Modern ice bucket
 Seau à glace Modern
 Eiswürfelbehälter Modern
 Cubo hielo Modern

Acciaio Inox - St. Steel

		ø cm	ø in	H cm	H in
V78 05 20 00 11 401	est	15	6	17	6,3/4
	int	13	5,1/8		

**Secchio champagne Modern**

Modern Champagne cooler
 Seau à champagne Modern
 Modern Champagnekühler
 Cubo champán Modern

Acciaio Inox - St. Steel

		ø cm	ø in	H cm	H in
V78 05 20 002		24	9,1/2	22,5	8,7/8

**Glacette**

Modern glacette
 Glacette Modern
 Weinkühler Modern
 Enfriador de botella

Acciaio Inox - St. Steel

		ø cm	ø in	H cm	H in
V78 05 24 01 01 401	est	12	4.3/4	19,5	7,5/8
	int	10	4		

**Supporto secchio Basic**

Basic champagne cooler stand
 Support pour seau à champagne Basic
 Basic Champagnekühler Ständer
 Soporte para cubo champán Basic

Acciaio Inox 18/10 - St. Steel 18/10**Acciaio Inox - St. Steel**

		ø cm	ø in	H cm	H in
V01 05 20 674		21	8,1/4	63	24,3/4

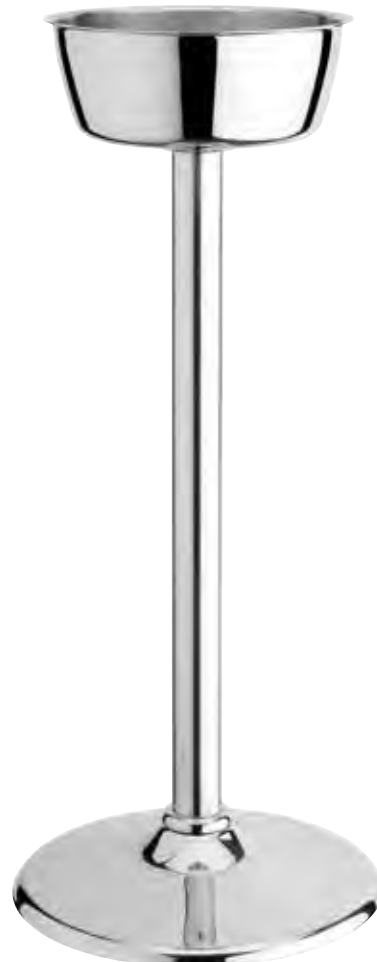

Secchio ghiaccio Imperial

Imperial ice bucket
 Seau à glace Imperial
 Imperial Eiswürfelbehälter
 Cubo hielo Imperial

Acciaio Inox - St. Steel

	ø cm	ø in	H cm	H in
V01 05 20 013	13,5	5,3/8	13	5,1/8

**Secchio champagne Imperial**

Imperial champagne cooler
 Seau à champagne Imperial
 Imperial Champagnekühler
 Cubo champán Imperial

Acciaio Inox - St. Steel

	ø cm	ø in	H cm	H in
V01 05 20 020	21	8,1/4	20	7,7/8

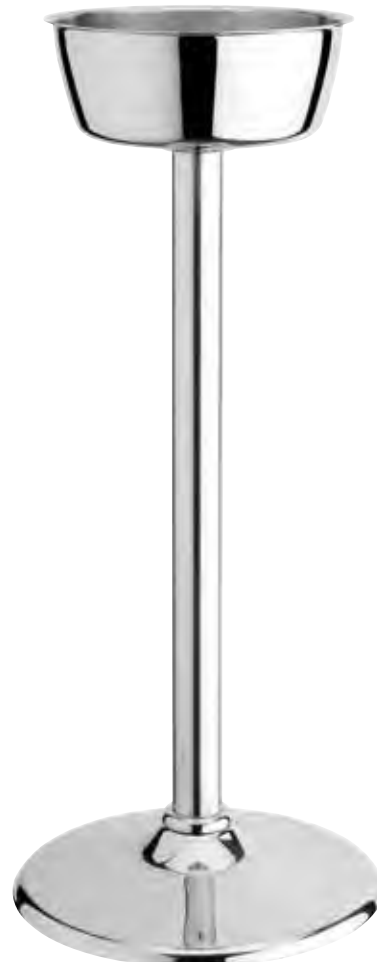
**Supporto secchio Imperial**

Imperial champagne cooler stand
 Support pour seau à champagne Imperial
 Imperial Champagnekühler Ständer
 Soporte para cubo champán Imperial

Acciaio Inox 18/10 - St. Steel 18/10

	ø cm	ø in	H cm	H in
V01 05 20 675	21	8,1/4	61	24

Secchio Cacao con pomolo

Cacao bucket with knob
 Seau Cacao avec poignée
 Champagnekühler Cacao mit Knopf
 Champañera Cacao con pomo

Acciaio inox 18/10 - St. steel 18/10

	Ø Cm	H. Cm	Ø In	H. In
V36 05 20 P01	19	19,5	7,1/2	7,5/8
V36 05 20 P02	13	12	5,1/8	4,3/4

**Supporto secchio Cacao**

Cacao champagne cooler stand
 Support pour seau à champagne Cacao
 Cacao Champagnekühler Ständer
 Soporte para champañera Cacao

Acciaio inox 18/10 - St. steel 18/10

	Cm	In
V36 05 20 001	59,5	23,1/2



Secchio ovale Modern

Modern Champagne cooler
 Seau à champagne ovale Modern
 Modern oval Champagnenkühler
 Champañera oval Modern

Acciaio inox 18/10 - St. steel 18/10

	Ø Cm	H. Cm	Ø In	H. In
V78 05 20 003	27	21,5	10,5/8	8,5/1

**Supporto secchio ovale Modern**

Champagne bucket stand
 Support pour seau à champagne
 Sektühlerständer
 Soporte champañera

Acciaio inox 18/10 - St. steel 18/10

	Cm	In	Ø Cm	Ø In
V78 05 20 677	59,5	23,1/2	25,5	10



Secchio Modern

Modern Champagne cooler
 Seau à champagne Modern
 Modern Champagnekühler
 Cubo champán Modern

Acciaio inox 18/10 - St. steel 18/10

	Ø Cm	H. Cm	Ø In	H. In
V78 05 20 002	24	22,5	9,1/2	8,7/8

**Supporto secchio Modern**

Modern champagne cooler stand
 Support pour seau à champagne Modern
 Modern Champagnekühler Ständer
 Soporte para cubo champán Modern

Acciaio inox 18/10 - St. steel 18/10

	Cm	In
V78 05 20 676	57	22,1/2

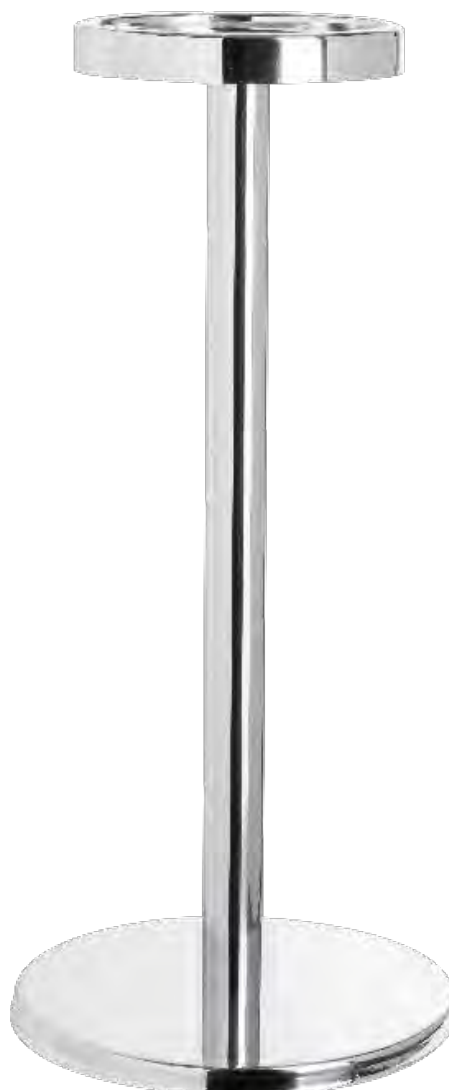

Secchio spumante 1 bottiglia

Champagne bucket, 1-bottle
 Seau à champagne 1 bouteille
 Champagneschale (Für 1Flasche)
 Cubo champán 1 botella

	cm	H cm	in	H in
V81 12 20 001 Plex -Transparent	22x16	23,5	8,5/8x6,1/4	9,1/4
V81 12 20 004 PS - Transparent	22x16	23,5	8,5/8x6,1/4	9,1/4
V81 12 20 007 PS Bianco - White	22x16	23,5	8,5/8x6,1/4	9,1/4

**Secchio spumante Magnum**

Magnum bucket
 Seau Magnum
 Champagneschale Magnum
 Cubo Magnum

	cm	H cm	in	H in
V81 12 20 002 Plex -Transparent	27,9x17,3	23,4	11x6,7/8	9,1/4
V81 12 20 005 PS - Transparent	27,9x17,3	23,4	11x6,7/8	9,1/4
V81 12 20 008 PS Bianco - White	27,9x17,3	23,4	11x6,7/8	9,1/4

**Secchio spumante Jeroboam**

Jeroboam bucket
 Seau Jeroboam
 Champagneschale Jeroboam
 Cubo Jeroboam

	cm	H cm	in	H in
V81 12 20 003 Plex -Transparent	48,2x20,9	24,3	19x8,1/4	9,5/8
V81 12 20 006 PS - Transparent	48,2x20,9	24,3	19x8,1/4	9,5/8
V81 12 20 009 PS Bianco - White	48,2x20,9	24,3	19x8,1/4	9,5/8



Secchio champagne Basic

Basic champagne bucket
Seau à champagne Basic
Sektkübler Basic
Cubo champán Basic

Acciaio Inox - St. Steel

	ø cm	ø in	H cm	H in
906 05 013	21,5	8,1/2	21	8,1/4

**Secchio ghiaccio Basic**

Basic ice bucket
Seau à glace Basic
Eiskühler Basic
Cubo hielo Basic

Acciaio Inox - St. Steel

	ø cm	ø in	H cm	H in
906 05 012	13	5,1/8	13	5,1/8

**Cocktail shaker Basic**

Basic cocktail shaker
Cocktail shaker Basic
Cocktail Shaker Basic
Coctelera Basic

Acciaio Inox - St. Steel

	lt	Oz
V78 05 81 SHA11 401	0,5	17

**Misurino Basic**

Basic jigger
Mésure Basic
Meßbecher Basic
Medida bar Basic

Acciaio Inox - St. Steel

	ml	Oz
V78 05 81 DOS1	15-30	1/2-1

**Filtro cocktail Basic**

Basic cocktail strainer
Passoire à cocktail Basic
Barsieb Basic
Colador de cóctel Basic

Acciaio Inox - St. Steel

	cm	in
V78 05 81 FCO1	14	5,1/2

**Denocciatore**

Olive and cherry pitter
Dénoyateur à olives Entkerner
Entkerner
Deshuesador aceitunas

Acciaio Inox 18/10 - St. Steel 18/10

	cm	in
V78 05 81 DEN	16,2	6,3/8



Coppa punch

Punch bowl
Bol à punch
Punchschale
Champañera

Acciaio Inox 18/10 - St. Steel 18/10

	ø cm	ø in	lt	Oz
V77 05 52 PUN	40	15,3/4	13	439,5

**Coppa champagne con base**

Champagne-bottle holder with base
Coupe à champagne avec base
Champagnerschale mit Basis
Champañera con base

Acciaio Inox 18/10 - St. Steel 18/10

	ø cm	ø in	lt	Oz
V77 05 52 PUN3	53	20,7/8	25	845

**Coppa punch doppio corpo**

Punch bowl double-wall
Bol à punch double paroi
Doppelwandiger Punchschale
Champañera doble pared

Acciaio Inox 18/10 - St. Steel 18/10

	ø cm	ø in	lt	Oz
V77 05 52 PUN2	39	15,3/8	10	338

**Coppa champagne**

Champagne bottle holder
Coupe à champagne
Champagnerschale
Champañera

Acciaio Inox 18/10 - St. Steel 18/10

	ø cm	ø in	lt	Oz
V77 05 52 PUN1	53	20,7/8	25	845



Cremiera Imperial

Imperial creampot
Crémier Imperial
Imperial Sahnekännchen
Jarrita de leche Imperial

Acciaio Inox 18/10 - St. Steel 18/10

	Cl	Oz
V01 05 03 015	15	5

**Lattiera Imperial**

Imperial milkpot
Pot à lait Imperial
Imperial Milchkanne
Lechera Imperial

Acciaio Inox 18/10 - St. Steel 18/10

	Cl	Oz
V01 05 03 035	35	12
V01 05 03 060	60	20
V01 05 03 100	100	35

**Porta cucchiaini**

Spoon holder
Porte-cuillères
Löffelbehälter
Portacucharillas

Acciaio Inox 18/10 - St. Steel 18/10

	ø cm	ø in	H cm	H in
V01 05 71 008	9	3,1/2	8	3,1/8

**Portacannucce**

Straw holder
Porte-pailles
Trinkhalmbehälter
Porta pajitas

Acciaio Inox 18/10 - St. Steel 18/10

	ø cm	ø in	H cm	H in
V01 05 71 011	9	3,1/2	11	4,3/8



Portacucchiaini a 3 posti Europa

Europa spoon holder, 3-sector
 Porte cuillères 3 secteurs Europa
 Kaffeeöffelständer 3 Sektoren Europa
 Porta cucharitas 3 sectores Europa

Acciaio Inox 18/10 - St. Steel 18/10

	cm	in	H cm	H in
CI 22202	27x8	10,5/8x3,1/8	8,5-10-12	3,3/8 - 4 - 4,3/4



Portacucchiaini a 2 posti Europa

Europa spoon holder, 2-sector
 Porte cuillères 2 secteurs Europa
 Kaffeeöffelständer 2 Sektoren Europa
 Porta cucharitas 2 sectores Europa

Acciaio Inox 18/10 - St. Steel 18/10

	cm	in	H cm	H in
CI 22201	17x8	6,3/4x3,1/8	8,5 - 10	3,3/8 - 4



Spargicacao con coperchio in plastica

Cocoa shaker with plastic cover
 Saupoudreuse de cacao à couvercle en plastique
 Kakaostreuer mit Plastikdeckel
 Espolvoreador con tapa en plástico

Acciaio Inox 18/10 - St. Steel 18/10

	ø cm	ø in
909 05 XX 028	5,3	2,1/8



Portabustine zucchero/tè

Packed sugar/tea holder
 Conteneur sachets de sucre/té
 Zucker und-Teebeutel Behälter
 Portasobres de azúcar/té

Acciaio Inox 18/10 - St. Steel 18/10

	cm	in	H cm	H in
V78 05 04 PBU	10x6,5	3,7/8x2,1/2	3,5	1,3/8



Portatovaglioli Square

Napkin holder
 Porte-serviettes
 Serviettenhalter
 Servilletero

Acciaio Inox 18/10 - St. Steel 18/10

	cm	in	H cm	H in
V76 05 71 001	11x4	4,3/8x1,2/3	2	3,1/8



Portatovaglioli da banco verticale

Vertical napkin holder
 Porte-serviettes vertical
 Vertikaler Thekenserviettenhalter
 Servilletero cuadrado vertical

Acciaio Inox 18/10 - St. Steel 18/10

	cm	in	H cm	H in
906 05 008	8,5x11	3,3/8x4,3/8	16	6,1/4



Set 12pz cannuce dritte lucide + 1 scovolino

Straw set 12-pc mirror finished + 1 cleaner

Set 12 pcs pailles droites polies + 1 brosse

Set 12 pzs pajitas rectas pulidas + 1 cepillo

12-teiliges Set Strohhalme gerade; hochglanz poliert + 1 Reiniger

Acciaio Inox 18/10 - St. Steel 18/10

	L mm	ø mm	L in	Ø in
90305730012				
cannuce/ straws	215	6	8,1/2	2,3/8
scovolino / cleaner	200	6	7,7/8	2,3/8

**Set 12pz cannuce con piega lucide + 1 scovolino**

Straw set 12-pc bent mirror finished + 1 cleaner

Set 12 pcs pailles droites pliées + 1 brosse

Set 12 pzs pajitas rectas dobladas + 1 cepillo

12-teiliges Set Strohhalme gebogen; hochglanz poliert + 1 Reiniger

Acciaio Inox 18/10 - St. Steel 18/10

	L mm	ø mm	L in	Ø in
9030573002				
cannuce/ straws	215	6	8,1/2	2,3/8
scovolino / cleaner	200	6	7,7/8	2,3/8

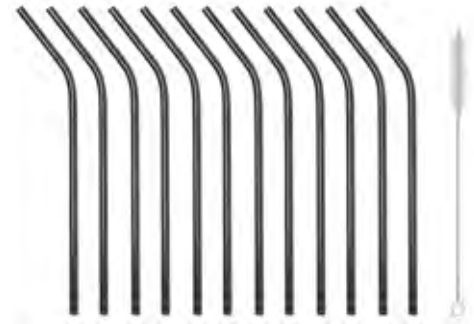
**Set 12pz cannuce dritte PVD Arcobaleno + 1 scovolino**

Arcobaleno straw set 12-pc straight PVD + 1 cleaner

Set 12pcs pailles Arcobaleno droites PVD +1 brosse

Set 12pzs pajitas Arcobaleno rectas PVD +1 cepillo

12-teiliges Set Strohhalme gerade; Arcobaleno PVD + 1 Reiniger

Acciaio Inox 18/10 - St. Steel 18/10

	L mm	ø mm	L in	Ø in
903057300181				
cannuce/ straws	215	6	8,1/2	2,3/8
scovolino / cleaner	200	6	7,7/8	2,3/8

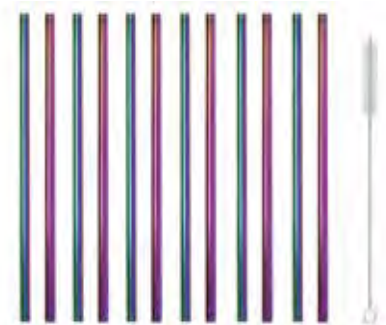
**Set 12pz cannuce con piega PVD Arcobaleno + 1 scovolino**

Arcobaleno set 12pz straws bent PVD+ 1 cleaner

Set 12pcs pailles Arcobaleno pliées PVD +1 brosse

Set 12pzs pajitas Arcobaleno dobladas PVD +1 cepillo

12-teiliges Set Strohhalme gebogen; Arcobaleno PVD + 1 Reiniger

Acciaio Inox 18/10 - St. Steel 18/10

	L mm	ø mm	L in	Ø in
903057300281				
cannuce/ straws	215	6	8,1/2	2,3/8
scovolino / cleaner	200	6	7,7/8	2,3/8

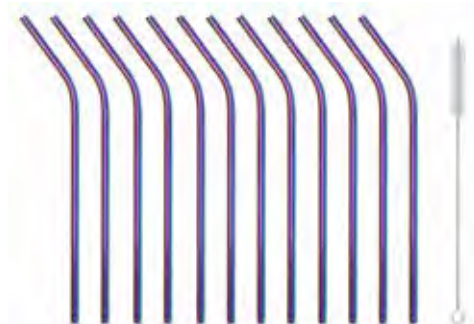

Set 12pz cannuce dritte PVD Copper + 1 scovolino

Copper straw set 12-pc PVD + 1 cleaner

Set 12pcs pailles Copper droites PVD +1 brosse

Set 12pzs pajitas Copper rectas PVD +1 cepillo

12-teiliges Set Strohhalme gerade; Kupfer PVD + 1 Reiniger

Acciaio Inox 18/10 - St. Steel 18/10

	L mm	ø mm	L in	Ø in
903057300140				
cannuce/ straws	215	6	8,1/2	2,3/8
scovolino / cleaner	200	6	7,7/8	2,3/8

**Set 12pz cannuce con piega PVD Copper + 1 scovolino**

Copper straw set 12-pc bent PVD + 1 cleaner

Set 12pcs pailles Copper pliées PVD +1 brosse

Set 12pzs pajitas Copper dobladas PVD +1 cepillo

12-teiliges Set Strohhalme gebogen; Kupfer PVD + 1 Reiniger

Acciaio Inox 18/10 - St. Steel 18/10

	L mm	ø mm	L in	Ø in
903057300240				
cannuce/ straws	215	6	8,1/2	2,3/8
scovolino / cleaner	200	6	7,7/8	2,3/8

**Set 12pz cannuce dritte PVD Gold + 1 scovolino**

Straw set 12-pc Gold straight PVD + 1 cleaner

Set 12pcs pailles Gold droites PVD +1 brosse

Set 12pzs pajitas Gold rectas PVD +1 cepillo

12-teiliges Set Strohhalme gerade; Gold PVD + 1 Reiniger

Acciaio Inox 18/10 - St. Steel 18/10

	L mm	ø mm	L in	Ø in
903057300141				
cannuce/ straws	215	6	8,1/2	2,3/8
scovolino / cleaner	200	6	7,7/8	2,3/8

**Set 12pz cannuce con piega PVD Gold + 1 scovolino**

Copper straw set 12-pc bent PVD + 1 cleaner

Set 12pcs pailles Gold pliées PVD +1 brosse

Set 12pzs pajitas Gold dobladas PVD +1 cepillo

12-teiliges Set Strohhalme gebogen; Gold PVD + 1 Reiniger

Acciaio Inox 18/10 - St. Steel 18/10

	L mm	ø mm	L in	Ø in
903057300241				
cannuce/ straws	215	6	8,1/2	2,3/8
scovolino / cleaner	200	6	7,7/8	2,3/8







- BUFFET



Urban

Abert firma Urban, un supporto creativo per le preparazioni in sala, versatile, fantasioso e bello da vedere.

Base ideale per un buffet di finger food, impeccabile supporto da colazione grazie ai numerosi accessori correlati e perfetto allestimento emozionale per aperitivi e brunch.

Urban è facile da allestire e consente la veloce creazione di figure geometriche modulari sempre diverse, per posizionare ogni creazione culinaria secondo la propria fantasia.

Abert has designed Urban, a creative support for food preparation in the restaurants, versatile, multipurpose and nice to see.

Ideal base for a finger-food buffet, perfect lunch podium system thanks to the numerous accessories provided, and impressive set-up for the happy hour and the brunch.

Urban is easy to assemble and allows the fast creation of continuously different modular shapes, in order to place every food preparation according to everyone's imagination.



**SET 1**

Urban Tower
Tower Urban
Tower Urban
Urban Tower

V87 32 42 001	cm	H cm
	140x42	67
	in	H in
	55,1/8x16,1/2	26,3/8

**SET 4**

Urban Tower
Tower Urban
Tower Urban
Urban Tower

V87 32 42 004	cm	H cm
	260x42	67
	in	H in
	102,1/8x16,1/2	26,3/8





SET 3

Urban Tower
Tower Urban
Tower Urban
Urban Tower

V87 32 42 003

cm	H cm
150x145	67
in	H in
59,1/8x57,1/8	26,3/8

SET 2

Urban Tower
Tower Urban
Tower Urban
Urban Tower

V87 32 02 002

cm	H cm
140x42	43
in	H in
55,1/8x16,1/2	17



Tower

Tower
Tower
Tower
Tower

	cm	H cm	in	H in
V87 18 42 001	20x20	10	7,7/8x7,7/8	4
V87 18 42 002	20x20	22	7,7/8x7,7/8	8,5/8
V87 18 42 003	20x20	34	7,7/8x7,7/8	13,3/8
V87 18 42 004	20x20	58	7,7/8x7,7/8	22,7/8

**Modulo a croce**

Cross-shaped extension unit
Croix
Verbindungskreuz
Módulo con forma de cruz

	H cm	in
V87 18 42 CRO	9,5	3,3/4

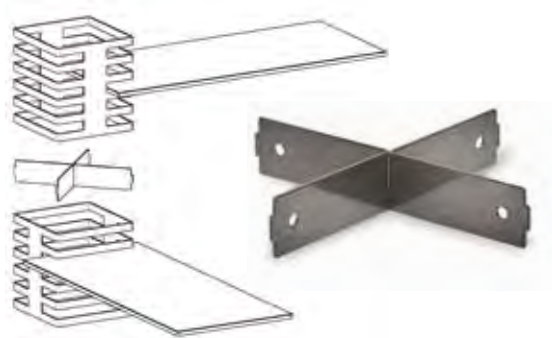
**Scala angolare 4 ripiani**

4-shelf corner ladder
Étagère angulaire 4 étages
Eck-Leiter (4 Stufen) Plexiglas
Escalera angular 4 estantes

	cm	H cm	in	H in
V87 12 42 SA2	40x40	10	15,3/4x15,3/4	4

**Coppa quadrata in plexiglass fumé**

Smoky plexiglass salad bowl, square
Bol plexiglass fumé carrén
Salatschale Plexiglas viereckig Smoky
Ensaladera acrílica fumé cuadrada

	cm	H cm	in	H in
V87 12 42 C01	34x34	11	13,3/8x13,3/8	4,3/8
V87 12 42 C02	34x34	19	13,3/8x13,3/8	7,1/2

**Piatto quadrato plexiglass fumé**

Smoky plexiglass buffet plate, square
Plat plexiglass fumé carré
Buffetplatte Plexiglas viereckig Smoky
Plato acrílico fumé cuadrado

	cm	in
V87 12 42 P01	30x30	11,3/4x11,3/4



Piano in vetro fumé

Smoky glass top
 Dessus en verre fumé
 Glasplatte Smoky
 Tablero de cristal fumé

	cm	in
V87 08 42 Q01	30x30	11,3/4x11,3/4
V87 08 42 Q02	42x42	16,1/2x16,1/2
V87 08 42 R01	30x70	11,3/4x27,1/2
V87 08 42 R02	30x100	11,3/4x39,3/8
V87 08 42 R03	42x70	16,1/2x27,1/2
V87 08 42 R04	42x100	16,1/2x39,3/8

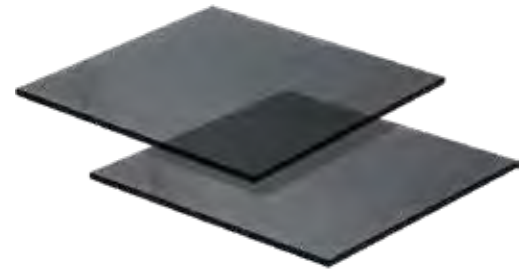

Piano in ardesia

Slate top
 Dessus en ardoise
 Schieferplatte
 Tablero de pizarra

	cm	in
V87 09 42 Q01	30x30	11,3/4x11,3/4
V87 09 42 Q02	42x42	16,1/2x16,1/2
V87 09 42 R01	30x70	11,3/4x27,1/2
V87 09 42 R02	30x100	11,3/4x39,3/8
V87 09 42 R03	42x70	16,1/2x27,1/2
V87 09 42 R04	42x100	16,1/2x39,3/8



Piano in mdf

Mdf top
 Dessus en mdf
 Mdf Platte
 Tablero de mdf

	cm	in
V87 04 42 Q01	30x30	11,3/4x11,3/4
V87 04 42 Q02	42x42	16,1/2x16,1/2
V87 04 42 R01	30x70	11,3/4x27,1/2
V87 04 42 R02	30x100	11,3/4x39,3/8
V87 04 42 R03	42x70	16,1/2x27,1/2
V87 04 42 R04	42x100	16,1/2x39,3/8

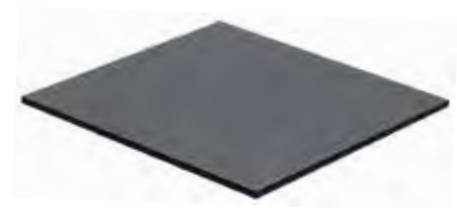

Totem

Totem
 Totem
 Totem
 Totem

	cm	H cm	in	H in
V87 18 42 T01	29x29	14	11,1/2x11,1/2	5,1/2
V87 18 42 T02	42x42	22	16,1/2x16,1/2	8,5/8



* Venduto senza ripiano / Sold without shelf

Scaldavivande da incasso con coperchio in acciaio Inox

Built-in chafing dish with St. Steel cover
Chafing dish encastrable avec couvercle en acier Inox
Chafing Dish zum Einbauen mit Edelstahl Deckel
Chafing dish para empotrar con tapa en acero Inox

Acciaio Inox 18/10 - St. Steel 18/10

	GN	cm	H cm
V87 18 52 002	1/1	60,5x40,5	39,5
		in	H in
		23,7/8x16	15,1/2

2 fornelli - 2 burners



**Completo di due fornelli a combustibile solido
e predisposto per piastra elettrica.
Portavivande in acciaio incluso**

*With two solid fuel burners,
electric heating element available.
With Gastronorm food pan*



Scaldavivande da incasso con coperchio in acciaio Inox /vetro

Built-in chafing dish with St. Steel / glass cover
Chafing dish encastrable avec couvercle en acier Inox / verre
Chafing Dish zum Einbauen mit Edelstahl / Glass Deckel
Chafing dish para empotrar con tapa en acero Inox / vidrio

	GN	cm	H cm
V87 18 52 003	1/1	60,5x40,5	39,5
		in	H in
		23,7/8x16	15,1/2

2 fornelli - 2 burners



**Completo di due fornelli a combustibile solido
e predisposto per piastra elettrica
Portavivande in acciaio incluso**

*With two solid fuel burners,
electric heating element available.
With GN 1/1 Gastronorm food pan*



Scaldavivande con gambe e coperchio in acciaio Inox

Chafing dish with St. Steel stand and cover
Chafing dish avec support et couvercle en acier Inox
Chafing Dish mit Beinen und Edelstahldeckel
Chafing dish con soporte y tapa en acero Inox

Acciaio Inox 18/10 - St. Steel 18/10

	GN	cm	H cm
V87 18 52 001	1/1	63x42	31
		in	H in
		25,3/4x16,1/2	12,1/4

2 fornelli - 2 burners

	GN	cm	H cm
V87 18 52 004	2/3	46x42	32
		in	H in
		18,1/8x16,1/2	12,5/8

1 fornello - 1 burner

**Completo di due fornelli a combustibile solido e predisposto per piastra elettrica.
Portavivande in acciaio incluso**

**With two solid fuel burners,
electric heating element available.
With Gastronorm food pan**



Scaldavivande con gambe e coperchio acciaio Inox/vetro

Chafing dish with St. Steel/glass stand and cover
Chafing dish avec support et couvercle en acier Inox / verre
Chafing Dish mit Beinen und Edelstahl / Glasdeckel
Chafing dish con soporte y tapa en acero Inox / vidrio

Acciaio Inox 18/10 - St. Steel 18/10

	GN	cm	H cm
V87 18 52 005	1/1	63x42	33
		in	H in
		25,3/4x16,1/2	12,1/4

2 fornelli - 2 burners

	GN	cm	H cm
V87 18 52 006	2/3	46x42	32
		in	H in
		18,1/8x16,1/2	12,5/8

1 fornello - 1 burner

**Completo di due fornelli a combustibile solido e predisposto per piastra elettrica.
Portavivande in acciaio incluso**

**With two solid fuel burners,
electric heating element available.
With GN 1/1 Gastronorm food pan**

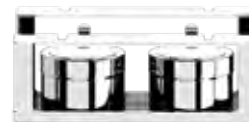

Caratteristiche tecniche

- A** Asportabilità del coperchio a 90° con estrema facilità.
- B** Coperchio leggero e facilmente maneggiabile.
- C** Blocco automatico dell'estrazione del coperchio in fase di lavoro (da 0° a 89°).
- D** Chiusura e apertura frenata del coperchio. Sistema di cerniere brevettate Abert
- E** Il coperchio si ferma, quando è lasciato, in qualsiasi posizione da 0° a 70°.
- F** Superati i 70° il coperchio si apre completamente lasciandolo andare.
- G** La cerniera è un meccanismo a molla, inalterabile nel tempo, non necessita di regolazione e di manutenzione in quanto non ha frizione.
- H** Tutti i meccanismi sono costruiti in pregiati materiali inossidabili, quindi resistenti alla corrosione, agli ambienti umidi e adatti al contatto con gli alimenti.
- I** Lo scaldavivande è progettato per raccogliere la condensa in modo da lasciare il piano di appoggio completamente asciutto.
- L** Può essere utilizzato sia con riscaldamento elettrico sia con fornelli a combustibile solido.

Technical characteristics

- A** Easily removable cover, at 90°.
- B** Light and easy-to-handle cover.
- C** Automatic block of cover pull out when in operation (from 0° to 89°).
- D** Closing and opening slowed by cover. Abert patented system.
- E** The cover stops, when released, in any position from 0° to 70°.
- F** Over 70° the cover opens fully when released.
- G** The hinge is a spring mechanism, inalterable in time, it does not need regulation and maintenance as it has no clutch.
- L** All the machineries are built in refined stainless materials, thus resistant to corrosion, humid environment and suitable for food contact.
- I** The chafing dish is designed to collect condensation, in order to keep the support base completely dry.
- L** Both electric warming and solid-fuelburners can be used.

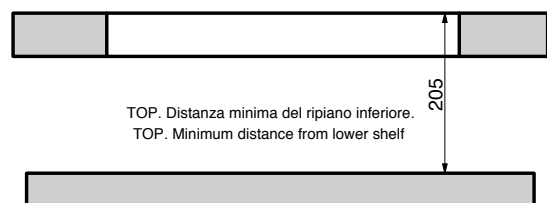
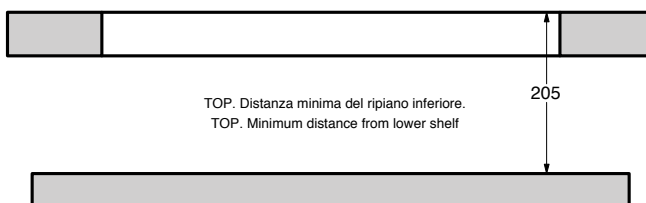
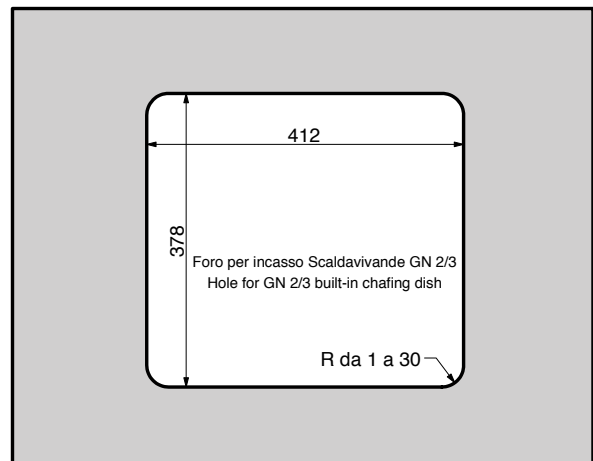
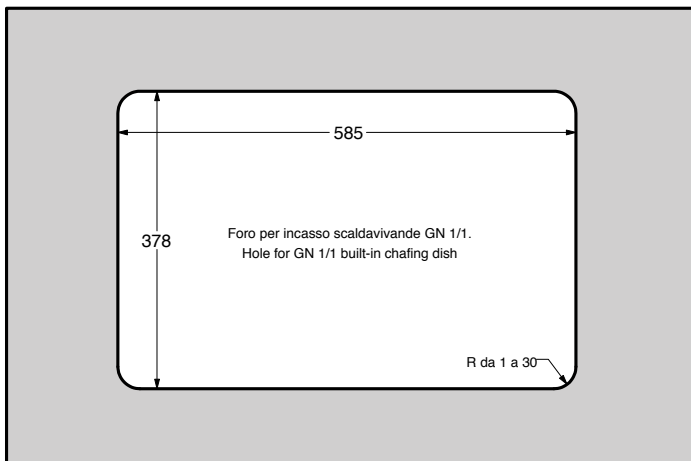





Scaldavivande GN 1/1 per supporti Urban

GN 1/1 built-in chafing dish
Chafing dish encastrable GN 1/1
Eingebautes Chafing Dish GN 1/1
Chafing dish empotrable GN 1/1

Acciaio Inox 18/10 - St. Steel 18/10

V87 18 520 02 Con coperchio in acciaio Inox - With st. Steel cover
V87 18 520 03 Con coperchio in vetro - With glass cover

Predisposto per piastra elettrica. Portavivande GN 1/1 in acciaio incluso.
Supporti Urban e fornelletti esclusi.

Electric heating element available. With GN 1/1 Gastronorm food pan.
Urban stand and burners excluded.



Coperchio GN 1/1

GN 1/1 St. Steel cover
Couvercle an acier Inox GN 1/1
Edelstahldeckel GN 1/1
Tapa de acero Inox GN 1/1

Acciaio Inox 18/10 - St. Steel 18/10

	H cm	H in	
B03 05 52 665	7,2	2,3/4	Acciaio Inox - St. Steel
G03 05 52 679	7,2	2,3/4	Vetro - Glass



Inserto GN 1/1

GN 1/1 container
Conteneur GN 1/1
Gn - Behälter 1/1
Contenedor GN 1/1

Acciaio Inox 18/10 - St. Steel 18/10

	H cm	H in
V01 05 72 G11 B	6,5	2,1/2



Bagnomaria GN 1/1

Pan
Bassine
Einsatz tief
Cubeta

Acciaio Inox 18/10 - St. Steel 18/10

	H cm	H in
305 05 52 666	11	4,3/8



Fornelletto per scaldavivande

Chafing-dish burner
Porte brûleur pour chafing dish
Brennstoffhalter für Chafing Dish
Contenedor de combustible para chafing dish

V77 05 52 FDC Fornelletto - Burner (Venduto a parte)
B25 05 52 665 Supporto - Support



Supporto per set refrigerato

Stand for thermal set
Support pour set réfrigéré
Ständer für Thermo-Einsatz
Soporte para set refrigerado

V87 18 42 PCH7

**Set refrigerato a incastro GN 1/1**

GN 1/1 built-in thermal set
Set réfrigéré encastrable GN 1/1
Eingebautes Thermo-Einsatz GN 1/1
Set refrigerado empotrable GN 1/1

Acciaio Inox 18/10 - St. Steel 18/10

V87 18 520 07 Con coperchio in vetro - With glass cover

Set refrigerato GN 1/1 H7,2 cm completo di bacinella in acciaio Inox, griglia in acciaio Inox, eutettici, vassoio GN 1/1 Hcm 2 in acciaio Inox. Supporti Urban esclusi.

Thermal set GN 1/1 H 7,2 cm with st. Steel pan, st. Steel grid, ice packs, st. Steel tray GN 1/1 H cm 2. Urban stand exclude

**Coperchio GN 1/1**

GN 1/1 glass cover
Couverche en verre GN 1/1
Glasdeckel GN 1/1
Tapa de vidrio GN 1/1

Acciaio Inox 18/10 - St. Steel 18/10

	H cm	H in
G03 05 52 670	7,2	2,3/4

**inserto GN 1/1**

GN 1/1 container
Conteneur GN 1/1
Gn - Behälter 1/1
Contenedor GN 1/1

Acciaio Inox 18/10 - St. Steel 18/10

	H cm	H in
V01 05 72 G11	2	0,3/4

**Griglia**

Grid
Grille
Gittereinsatz
Reja

	H cm	H in
B4 705 52 668	2	0,3/4

**Eutettico**

Ice pack
Bloc réfrigérant
Kühlakku
Acumulador de frío

V77 12 95 G00

**Bacinella GN 1/1**

Pan
Bassine
Einsatz tief
Cubeta

Acciaio Inox 18/10 - St. Steel 18/10

	H cm	H in
305 05 52 671	7,5	3

Supporto per set refrigerato

Stand for thermal set
Support pour set réfrigéré
Ständer für Thermo-Einsatz
Soporte para set refrigerado

V87 18 42 PCH1



inserto GN 1/1

GN 1/1 container
 Conteneur GN 1/1
 Gn - Behälter 1/1
 Contenedor GN 1/1

Acciaio Inox 18/10 - St. Steel 18/10

	cm	H cm	Sp. mm
V01 05 72 G11	53x32,5	2	0,7
V01 05 72 G11 B	53x32,5	6,5	0,7

**inserto GN 2/3**

GN 2/3 container
 Conteneur GN 2/3
 Gn - Behälter 2/3
 Contenedor GN 2/3

Acciaio Inox 18/10 - St. Steel 18/10

	cm	H cm	Sp. mm
V01 05 72 G23	35,4x32,5	2	0,7
V01 05 72 G23 B	35,4x32,5	6,5	0,7

**inserto GN 1/3**

GN 1/3 container
 Conteneur GN 1/3
 Gn - Behälter 1/3
 Contenedor GN 1/3

Acciaio Inox 18/10 - St. Steel 18/10

	cm	H cm	Sp. mm
V01 05 72 G13	32,5x17,6	2	0,7
V01 05 72 G13 A	32,5x17,6	4	0,7

**inserto GN 1/2**

GN 1/2 container
 Conteneur GN 1/2
 Gn - Behälter 1/2
 Contenedor GN 1/2

Acciaio Inox 18/10 - St. Steel 18/10

	cm	H cm	Sp. mm
V01 05 72 G12	32,5x26,5	2	0,7
V01 05 72 G12 B	32,5x26,5	6,5	0,7

**Piastra elettrica**

Electric hot plate
 Plaque électrique
 Elektrische Platte
 Placa eléctrica

V77 05 52 PCR

V77 05 52 PCR1 Con regolatore - With regulator



inserto GN 1/1

Food pan, GN 1/1
 Conteneur GN 1/1
 Porzellanbehälter, GN 1/1
 Contenedor GN 1/1

Porcellana - Porcelain

	H cm	H in
V01 21 52 G11B	6,5	2,1/2
V01 21 52 G11	2	0,3/4

**inserto GN 2/3**

Food pan, GN 2/3
 Conteneur GN 2/3
 Porzellanbehälter, GN 2/3
 Contenedor GN 2/3

Porcellana - Porcelain

	H cm	H in
V01 21 52 G23B	6,5	2,1/2

**inserto GN 1/2**

Food pan, GN 1/2
 Conteneur GN 1/2
 Porzellanbehälter, GN 1/2
 Contenedor GN 1/2

Porcellana - Porcelain

	H cm	H in
V01 21 52 G12B	6,5	2,1/2

**inserto GN 1/3**

Food pan, GN 1/3
 Conteneur GN 1/3
 Porzellanbehälter, GN 1/3
 Contenedor GN 1/3

Porcellana - Porcelain

	H cm	H in
V01 21 52 G13B	6,5	2,1/2

**Piatto piano quadrato**

Square flat plate
 Assiette carré
 Teller
 Plato cuadrado

Porcellana - Porcelain

	cm	H in
V01 21 42 P22	22x22	8,5/8x8,5/8







Tower

Tower
Tower
Tower
Tower

Ferro verniciato - Varnished Iron

	H cm	H in
V87 18 42 002	22	8,5/8
V87 18 42 003	34	13,3/8
V87 18 42 004	58	22,7/8

**Contentore Urban Organizer**

Urban Organizer container
Conteneur Urban Organizer
Urban-Organizer Holzbehälter
Contenedor Urban Organizer

Legno - Wood

	cm	in
V87 04 42 CS1	10x10x8	4x4x3,1/8

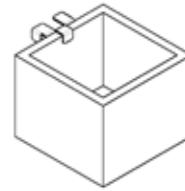
**Contentore Urban Organizer**

Urban Organizer container
Conteneur Urban Organizer
Urban-Organizer Holzbehälter
Contenedor Urban Organizer

Legno - Wood

	cm	in
V87 04 42 CS2	15x10x4	6x4x1,1/2

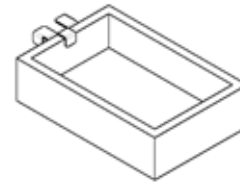
**Contentore Urban Organizer**

Urban Organizer container
Conteneur Urban Organizer
Urban-Organizer Holzbehälter
Contenedor Urban Organizer

Legno - Wood

	cm	in
V87 04 42 CS3	20x15x4	7,7/8x6x1,1/2
V87 04 42 CS4	20x15x8	7,7/8x6x3,1/8

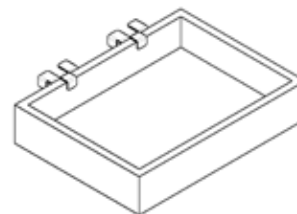
**Contentore Urban Organizer**

Urban Organizer container
Conteneur Urban Organizer
Urban-Organizer Holzbehälter
Contenedor Urban Organizer

Legno - Wood

	cm	in
V87 04 42 CS5	35x17,5x4	13,3/4x6,7/8x1,1/2
V87 04 42 CS6	35x17,5x8	13,3/4x6,7/8x3,1/8

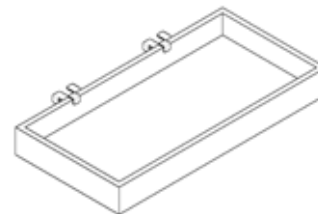
**Contentore Urban Organizer**

Urban Organizer container
Conteneur Urban Organizer
Urban-Organizer Edelstahlbehälter
Contenedor Urban Organizer

Acciaio Inox 18/10 - St. Steel 18/10

	cm	in
V87 05 42 CS1	6,5x10x4	2,1/2x4x1,1/2

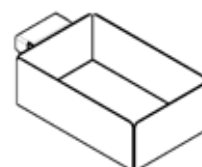

Contenitore Urban Organizer

Urban Organizer container
 Conteneur Urban Organizer
 Urban-Organizer Edelstahlbehälter
 Contenedor Urban Organizer

Acciaio Inox 18/10 - St. Steel 18/10

	cm	in
V87 05 42 CS2	10x6,5x4	4x2,2/1x1,1/2

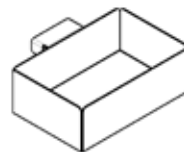
**Contenitore Urban Organizer**

Urban Organizer container
 Conteneur Urban Organizer
 Urban-Organizer Edelstahlbehälter
 Contenedor Urban Organizer

Acciaio Inox 18/10 - St. Steel 18/10

	cm	in
V87 05 42 CS3	18x4,5x4	7x1,3/4 x1,1/2

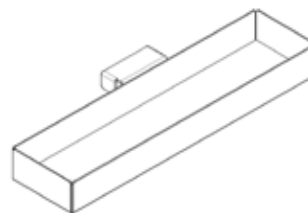
**Contenitore cilindrico per anello**

Cylindrical container for ring
 Conteneur cylindrique pour anneau
 Zylindrische Edelstahlbehälter für Ring
 Contenedor cilíndrico para anillo

Inox 18/10 - St. Steel

	Ø cm	Ø in	H cm	H in
V87 05 42 CS4	7,6	30	9,5	3,3/4

**Anello Urban Organizer**

Urban Organizer ring
 Anneau Urban organizer
 Edelstahlring für Urban-Organizer
 Anillo Urban Organizer

Acciaio Inox 18/10 - St. Steel 18/10

	Ø cm	Ø in
V87 05 42 A01	9	35,3/8

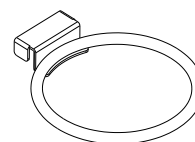
**Base per Tower Urban Organizer verniciata con perni**

Urban Organizer varnished, stand with pins
 Support Urban Organizer verni avec pivots
 Lackiert Gestell für Urban Tower, mit Zapfen
 Soporte Urban Organizer varnizado con pivotes

Ferro Verniciato - Varnished Iron

	cm	in
V87 18 42 B02	30x30	11,3/4x11,3/4

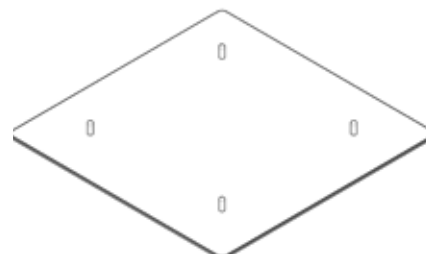
**Vassoio Urban Organizer**

Urban Organizer tray
 Plateau Urban Organizer
 Edelstahl Tablett für Urban Organizer
 Bandeja Urban Organizer

Acciaio Inox 18/10 - St. Steel 18/10

	cm	in
V87 05 42 V01	20x19	7,7/8x7,1/2

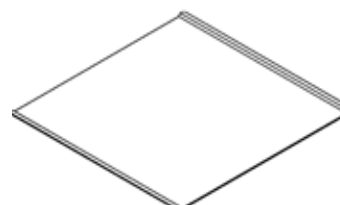





Revolution

Un'idea nuova ed originale nel concetto Buffet: **Mix&Play Revolution** consente con un tocco di creatività e fantasia di presentare cibi, bevande, stuzzichini ecc. ispirandosi ai diversi momenti di consumo (dalla colazione all'aperitivo) e alle tipologie dei locali. Un'opera d'arte che coniuga modernità e funzionalità in un prodotto che non ha eguali.

Le strutture in alluminio sono state pensate per soddisfare le differenti esigenze di spazio e di consumo del cliente. Sono l'esempio per eccellenza del concetto modulare consentendo la composizione di 5 differenti misure delle basi (2 quadrate e 3 rettangolari) per 3 differenti altezze. Con la creatività è possibile adattare **Mix&Play Revolution** Buffet al proprio spazio e creare sempre nuove ed originali presentazioni.

7 nuove composizioni studiate per facilitare la creazione del vostro buffet.

*A new and original idea for the buffet: **Mix&Play Revolution** allows to present food and beverages etc. at different times of the day and different kinds of place, with an incredible touch of creativity and fantasy. A work of art that matches modern day practicality in just one product. The only one!*

*The metal podio are created to satisfy the different needs of space and consumption. They are easy excellent example of modular concept allowing the composition of 5 different sizes of base (2 square and 3 rectangular) for 3 different heights. By being creative it is possible to adapt **Mix&Play Revolution** Buffet to any kind of space and always provide new and fantastic Buffet.*

7 new arrangements studied to make the preparation of your buffet easier.

Set 1

Set 1
Set 1
Set 1
Set 1

V86 32 42 003 Nero-Black
V86 32 42 010 Silver-Silver

cm	H cm	in	H in
52,5x70	24	20,5/8x27,1/2	9,1/2

**Set 2**

Set 2
Set 2
Set 2
Set 2

V86 32 42 004 Nero-Black
V86 32 42 011 Silver-Silver

cm	H cm	in	H in
35x70	24	13,3/4x27,1/2	9,1/2

**Set 3**

Set 3
Set 3
Set 3
Set 3

V86 32 42 005 Nero-Black
V86 32 42 012 Silver-Silver

cm	H cm	in	H in
52,5x70	22,5	20,5/8x27,1/2	8,7/8

**Set 4**

Set 4
Set 4
Set 4
Set 4

V86 32 42 006 Nero-Black
V86 32 42 013 Silver-Silver

cm	H cm	in	H in
52,5x70	22,5	20,5/8x27,1/2	8,7/8



Set 5

Set 5
Set 5
Set 5
Set 5

V86 32 42 007 Nero-Black
V86 32 42 014 Silver-Silver

cm	H cm	in	H in
52,5x70	16	20,5/8x27,1/2	6,1/4



Set 6

Set 6
Set 6
Set 6
Set 6

V86 32 42 008 Nero-Black
V86 32 42 015 Silver-Silver

cm	H cm	in	H in
52,5x52,5	16	20,5/8x20,5/8	6,1/4



Set 7

Set 7
Set 7
Set 7
Set 7

V86 32 42 009 Nero-Black
V86 32 42 016 Silver-Silver

cm	H cm	in	H in
52,5x52,5	16	20,5/8x20,5/8	6,1/4



Set Large

Set Large
Set Large
Set Large
Set Large

V86 32 42 L05 Nero-Black
V86 32 42 L06 Silver-Silver

cm	H cm	in	H in
122,5x87,5	30,5	48,1/4x34,1/2	12

**Set Small**

Set Small
Set Small
Set Small
Set Small

V86 32 42 S05 Nero-Black
V86 32 42 S08 Silver-Silver

cm	H cm	in	H in
87,5x52,5	26,5	34,1/2x20,5/8	10,3/8



Alzata modulare quadrata

Square modular podium
Etagère modulaire carrée
Modulständer, viereckig
Expositor modular cuadrado

	cm	H cm	in	H in
Argento - Silver				
V86 11 42 Q01	17,5x17,5	9,5	6,7/8x6,7/8	3,3/4
V86 11 42 Q02	17,5x17,5	16	6,7/8x6,7/8	6,1/4
V86 11 42 Q03	17,5x17,5	22,5	6,7/8x6,7/8	8,7/8
Nero - Black				
V86 15 42 Q01	17,5x17,5	9,5	6,7/8x6,7/8	3,3/4
V86 15 42 Q02	17,5x17,5	16	6,7/8x6,7/8	6,1/4
V86 15 42 Q03	17,5x17,5	22,5	6,7/8x6,7/8	8,7/8



Alzata modulare quadrata

Square modular podium
Etagère modulaire carrée
Modulständer, viereckig
Expositor modular cuadrado

	cm	H cm	in	H in
Argento - Silver				
V86 11 42 Q04	35x35	9,5	13,3/4x13,3/4	3,3/4
V86 11 42 Q05	35x35	16	13,3/4x13,3/4	6,1/4
V86 11 42 Q06	35x35	22,5	13,3/4x13,3/4	8,7/8
Nero - Black				
V86 15 42 Q04	35x35	9,5	13,3/4x13,3/4	3,3/4
V86 15 42 Q05	35x35	16	13,3/4x13,3/4	6,1/4
V86 15 42 Q06	35x35	22,5	13,3/4x13,3/4	8,7/8



Alzata modulare rettangolare

Rectangular modular podium
Etagère modulaire rectangulaire
Modulständer, rechteckig
Expositor modular rectangular

	cm	H cm	in	H in
Argento - Silver				
V86 11 42 R01	17,5x35	9,5	6,7/8x13,3/4	3,3/4
V86 11 42 R02	17,5x35	16	6,7/8x13,3/4	6,1/4
V86 11 42 R03	17,5x35	22,5	6,7/8x13,3/4	8,7/8
Nero - Black				
V86 15 42 R01	17,5x35	9,5	6,7/8x13,3/4	3,3/4
V86 15 42 R02	17,5x35	16	6,7/8x13,3/4	6,1/4
V86 15 42 R03	17,5x35	22,5	6,7/8x13,3/4	8,7/8



Alzata modulare rettangolare

Rectangular modular podium
Etagère modulaire rectangulaire
Modulständer, rechteckig
Expositor modular rectangular

	cm	H cm	in	H in
Argento - Silver				
V86 11 42 R04	17,5x52,5	9,5	6,7/8x20,5/8	3,3/4
V86 11 42 R05	17,5x52,5	16	6,7/8x20,5/8	6,1/4
V86 11 42 R06	17,5x52,5	22,5	6,7/8x20,5/8	8,7/8
Nero - Black				
V86 15 42 R04	17,5x52,5	9,5	6,7/8x20,5/8	3,3/4
V86 15 42 R05	17,5x52,5	16	6,7/8x20,5/8	6,1/4
V86 15 42 R06	17,5x52,5	22,5	6,7/8x20,5/8	8,7/8



Alzata modulare rettangolare

Rectangular modular podium
Etagère modulaire rectangulaire
Modulständer, rechteckig
Expositor modular rectangular

	cm	H cm	in	H in
Argento - Silver				
V86 11 42 R07	35x52,5	9,5	13,3/4x20,5/8	3,3/4
V86 11 42 R08	35x52,5	16	13,3/4x20,5/8	6,1/4
V86 11 42 R09	35x52,5	22,5	13,3/4x20,5/8	8,7/8
Nero - Black				
V86 15 42 R07	35x52,5	9,5	13,3/4x20,5/8	3,3/4
V86 15 42 R08	35x52,5	16	13,3/4x20,5/8	6,1/4
V86 15 42 R09	35x52,5	22,5	13,3/4x20,5/8	8,7/8



Piano legno quadrato

Square wooden base
 Tablette en bois carrée
 Holzplatte, viereckig
 Tablero de madera cuadrado

	cm	H cm	in	H in
V86 04 42 PQ1	17,5x17,5	0,8	6,7/8x6,7/8	0,3/8

**Piano legno rettangolare**

Rectangular wooden base
 Tablette en bois rectangulaire
 Holzplatte, rechteckig
 Tablero de madera rectangular

	cm	H cm	in	H in
V86 04 42 PR1	17,5x35	0,8	6,7/8x13,3/4	0,3/8

**Supporto legno inclinato quadrato**

Square modular podium
 Étagère modulaire carrée
 Holzgestell, viereckig, schräg gestellt
 Expositor modular cuadrado

	cm	H cm	in	H in
V86 04 42 SQ1	35x35	7,5	13,3/4x13,3/4	3

**Supporto legno inclinato rettangolare**

Rectangular modular podium
 Étagère modulaire rectangulaire
 Holzgestell, viereckig, schräg gestellt
 Expositor modular rectangular

	cm	H cm	in	H in
V86 04 42 SR1	35x52,5	7,5	13,3/4x20,5/8	3



Vassoio legno quadrato

Square wooden tray
 Plateau en bois carrée
 Holztablett, viereckig
 Bandeja de madera cuadrado

	cm	H cm	in	H in
V86 04 42 VQ1	35x35	4	13,3/4x13,3/4	1,1/2
V86 04 42 VQ2	35x35	8	13,3/4x13,3/4	3,1/8



Vassoio legno rettangolare

Rectangular wooden tray
 Plateau en bois rectangulaire
 Holztablett, rechteckig
 Bandeja de madera rectangular

	cm	H cm	in	H in
V86 04 42 VR1	17,5x35	4	6,7/8x13,3/4	1,1/2
V86 04 42 VR2	17,5x35	8	6,7/8x13,3/4	3,1/8



Vassoio legno rettangolare

Rectangular wooden tray
 Plateau en bois rectangulaire
 Holztablett, rechteckig
 Bandeja de madera rectangular

	cm	H cm	in	H in
V86 04 42 VR3	17,5x52,5	4	6,7/8x20,5/8	1,1/2
V86 04 42 VR4	17,5x52,5	8	6,7/8x20,5/8	3,1/8



Vassoio legno rettangolare

Rectangular wooden tray
 Plateau en bois rectangulaire
 Holztablett, rechteckig
 Bandeja de madera rectangular

	cm	H cm	in	H in
V86 04 42 VR5	35x52,5	4	13,3/4x20,5/8	1,1/2
V86 04 42 VR6	35x52,5	8	13,3/4x20,5/8	3,1/8



Piatto quadrato porcellana

Square porcelain platter
 Plat carré en porcelaine
 Porzellanteller, viereckig
 Plato cuadrado de porcellana

	cm	in
V86 21 42 PQP	17,5x17,5	6,7/8x6,7/8

**Piatto quadrato porcellana**

Square porcelain platter
 Plat carré en porcelaine
 Porzellanteller, viereckig
 Plato cuadrado de porcellana

	cm	in
V86 21 42 PQG	35x35	13,3/4x13,3/4

**Piatto rettangolare porcellana**

Rectangular porcelain platter
 Plat rectangulaire en porcelaine
 Porzellanteller, rechteckig
 Plato rectangular de por

	cm	in
V86 21 42 PRE	17,5x35	6,7/8x13,3/4

**Teglia rettangolare in porcellana**

Rectangular porcelain baker
 Plate a roti rectangular en porcelaine
 Porzellanbackform, rechteckig
 Fuente rectangular porcelana

	cm	in
V86 21 42 TRE	17,5x35	6,7/8x13,3/4

**Teglia quadrata in porcellana**

Square porcelain baker
 Plate a roti carré en porcelaine
 Porzellanbackform, viereckig
 Fuente cuadrada de porcelana

	cm	in
V86 21 42 TQU	35x35	13,3/4x13,3/4



Ciotola quadra porcellana

Porcelain bowl
Bol carré en porcelaine
Porzellanschale, viereckig
Bol cuadrado de porcellana

	cm	H cm	in	H in
V86 21 42 CQ14	14x14	8	5,1/2x5,1/2	3,1/8



Ciotola quadra porcellana

Porcelain bowl
Bol carré en porcelaine
Porzellanschale, viereckig
Bol cuadrado de porcellana

	cm	H cm	in	H in
V86 21 42 CQ7	7x7	3,5	2,3/4x2,3/4	1,3/8



Bicchieri vetro basso

Glass glass, small
Verre Ginco
Glass, klein
Vaso cristal bajo

	ø cm	H cm	lt
V86 08 42 BBA	6	8	0,10
	ø in	H in	Oz
	2,3/8	3,1/8	3,5



Bicchieri vetro alto

Glass glass, tall
Verre en verre haut
Glass, hoch
Vaso cristal alto

	ø cm	H cm	lt
V86 08 42 BAL	7	11	0,15
	ø in	H in	Oz
	2,3/4	4,3/8	5



Coppa in vetro

Glass bowl
Coupelle en verre
Glasschale
Bol de vidrio

	ø cm	H cm	ø in	H in
V86 08 42 C12	12	7	4,3/4	2,3/4



Set ABS

Set 1
Set 1
Set 1
Set 1

	cm	H cm	in	H in
V86 32 42 S06 Nero-Black	87x52,5	23	34,1/4x20,5/8	9
V86 32 42 S07 Silver-Silver	87x52,5	23	34,1/4x20,5/8	9



Piano in ABS nero quadrato liscio

Square plain black ABS base

Plat carré en abs noir

ABS Platte, schwarz viereckig und glatt

Base en ABS negra cuadrada lisa

	cm	in
V86 12 42 QLI 15	17,5x17,5	6,7/8x6,7/8

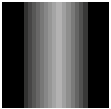
**Piano in ABS nero rettangolare liscio**

Rectangular plain black ABS base

Plat rectangulaire en ABS noir

ABS Platte, schwarz rechteckig und glatt

Base en ABS negra cuadrada lisa

	cm	in
V86 12 42 RLI 15	17,5x35	6,7/8x13,3/4

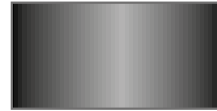
**Piano abs nero quadrato 1 foro grande**

Square Abs base with 1 hole

Plat carré en abs noir 1 trou grand

ABS Platte, schwarz mit einem Loch

Base en ABS negra con 1 agujero grande

	cm	in
V86 12 42 Q1F 15	17,5x17,5	6,7/8x6,7/8

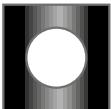
**Piano abs nero rettangolare 2 fori grandi**

Rectangular Abs base with 2 holes

Plat rectangulaire en ABS noir 2 trous grands

ABS Platte, schwarz rechteckig und mit 2 großen Löcher

Base en ABS negra rectangular, con 2 agujeros grandes

	cm	in
V86 12 42 R2F 15	17,5x35	6,7/8x13,3/4

**Piano abs nero quadrato 4 fori piccoli**

Square Abs base with 4 holes

Plat carré en ABS noir 4 trous petits

ABS Platte, schwarz viereckig mit 4 kleinen Löcher

Base en ABS negra cuadrada con 4 agujeros pequeños

	cm	in
V86 12 42 Q4F 15	17,5x17,5	6,7/8x6,7/8

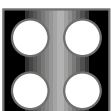
**Piano abs nero rettangolare 8 fori piccoli**

Rectangular Abs base with 8 holes

Plat rectangulaire en ABS noir 8 trous petits

ABS Platte, schwarz viereckig mit 8 kleinen Löcher

Base en ABS negra rectangular, con 8 agujeros pequeños

	cm	in
V86 12 42 R8F 15	17,5x35	6,7/8x13,3/4

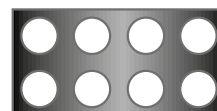

Distributore succhi

Juice dispenser
Distributeur jus
Saftdispenser
Dispensador de zumo

**Con rubinetto in metallo**

With metal tap
Avec robinet en métal
Mit Metallhahn
Con grifo de metal

	lt	Oz	cm	H cm	in	H in
V76 05 52 00 8R	3,5	118	20x31,5	51	7,3/4x12,1/2	20
V76 05 52 00 2R	7	237	27x37	56	10,5/8x14,1/2	22
V76 05 52 01 2R	12	405	27x37	51	10,5/8x14,1/2	20

**Con rubinetto in plastica**

With plastic tap
Avec robinet en plastique
Mit Kunststoffhahn
Con grifo de plástico

	lt	Oz	cm	H cm	in	H in
V76 05 52 00 9R	3,5	118	20x31,5	51	7,3/4x12,1/2	20
V76 05 52 00 3R	7	237	27x37	56	10,5/8x14,1/2	22
V76 05 52 01 3R	12	405	27x37	51	10,5/8x14,1/2	20

**Portaformaggi-affettati rettangolare refrigerato**

Thermal rectangular cheese dish
Plateau fromage - charcuterie rectangulaire réfrigérant
Rechteckige Aufschnittplatte, gekühlt
Quesera rectangular refrigerante

	cm	H cm	in	H in
V76 05 54 R0 1R	50x30	20	19,3/4x11,3/4	7,7/8





Distributore caffè

Coffee urn
Distributeur de café
Kaffeedispenser
Dispensador de café

	lt	cm	Hcm
V76 05 52 00 1R	10	26x33	64
	Oz	in	H in
	350	10,1/4x13	25,1/8



Distributore cereali singolo

Cereal dispenser
Distributeur céréales
Müeslidispenser
Dispensador de cereales

	lt	cm	Hcm
V76 05 52 01 0R	4	19,5x29	56
	Oz	in	H in
	135	7,3/4x11,3/8	22

	lt	cm	Hcm
V76 05 52 01 1R	7	19,5x29	70
	Oz	in	H in
	237	7,3/4x11,3/8	27,7/8





BUFFET SQUARE

Portaformaggi-affettati rettangolare refrigerato Square

Thermal rectangular cheese dish Square

Plateau fromage-charcuterie rectangulaire réfrigérant Square

Rechteckige Aufschnittplatte, gekühlt, Square

Quesera rectangular refrigerante Square

Acciaio Inox 18/10 - St. Steel 18/10

	cm	H cm	in	H in
V76 05 54 R01	50x30	20	19,5/8x11,7/8	7,7/8



Coperchio a bascula rettangolare trasparente

Transparent rectangular rolltop cover

Cloche basculante rectangulaire transparente

Rolltophaube-rechteckig

Campana rectangular transparente

SAN

	cm	in
V76 12 15 R01	47x27	18,1/2x10,5/8

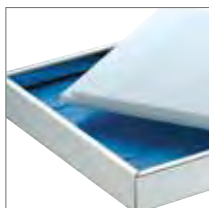

Tagliere rettangolare

Rectangular cutting board

Planche à découper rectangulaire

Rechteckiges Schneidebrett

Tabla de cortar rectangular

Polietilene

	cm	in
V77 12 71 R01	47x27	18,1/2x10,5/8



4 Eutettici rettangolari

4 Ice packs

4 Blocs réfrigérants

4 Kühlakkus

4 Acumuladores de frío rectangulares

V77 12 95 M00

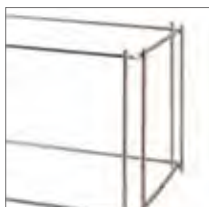

Alzata filo per basi rettangolari

Square wire stand for rectangular bases

Support en fil pour bases rectangulaires

Drahtständer für rechteckigen Sockel

Soporte filo de acero para bases rectangulares

Acciaio Inox 18/10 - St. Steel 18/10

	cm	H cm
V76 05 42 001	50x30	27,5

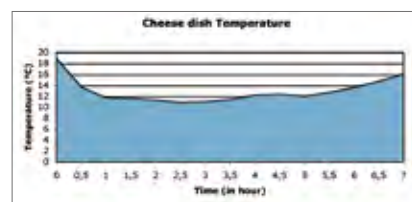

Temperatura ambiente
External temperature

19,6°

Temperatura acqua
Water temperature

18,9°

Mezzo refrigerante
Cooler system

8 eutettici ghiaccio piccoli
8 small ice packs

Portaformaggi-affettati tondo refrigerato Square

Thermal round cheese dish Square

Plateau fromage-charcuterie rond réfrigérant Square

Runde Aufschnittplatte, gekühlt, Square

Quesera redonda refrigerante Square

Acciaio Inox 18/10 - St. Steel 18/10

	cm	H cm	in	H in
V76 05 54 T01	38x38	23	14,8/8x14,8/8	9



Coperchio a bascula tondo trasparente

Transparent round rolltop cover

Cloche basculante ronde transparente

Rolltophaube - rund

Campana redonda transparente

SAN

	ø cm	ø in
V76 12 15 T01	34	13,3/8



Tagliere quadrato con scanal. tonda

Square cutting board with round groove

Planche à découper carrée avec rainure ronde

Viereckiges Schneidebrett mit runder Rille

Tabla de cortar cuadrada con ranura

Polietilene

	cm	in
V77 12 71 T01	35x35	13,3/4x13,3/4



Eutettici rettangolari

Ice packs

Blocs réfrigérants

Kühlakkus

Acumuladores de frío rectangulares

V77 12 95 M00

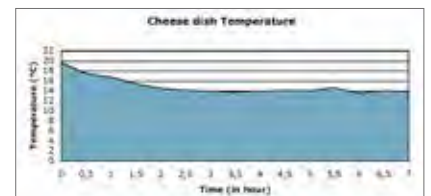

Temperatura ambiente
External temperature 20,9°

Temperatura acqua
Water temperature 19,5°

Mezzo refrigerante
Cooler system 4 eutettici ghiaccio piccoli
4 small ice packs

Distributore succhi Square

Square juice dispenser

Distributeur jus Square

Saftdispenser Square

Dispensador de zumo Square

**Con rubinetto in metallo**

With metal tap

Avec robinet en métal

Mit Metallhahn

Con grifo de metal

	cm	H cm	lt	Oz
V76 05 52 008	18x27,5	46	3,5	118
V76 05 52 002	24x31	50	7	237
V76 05 52 012	24x31	70	12	405

**Con rubinetto in plastica**

With plastic tap

Avec robinet en plastique

Mit Kunststoffhahn

Con grifo de plástico

	cm	H cm	lt	Oz
V76 05 52 009	17,5x27,5	41	3,5	118
V76 05 52 003	23,5x31	50	7	237
V76 05 52 013	23,5x31	78	12	405

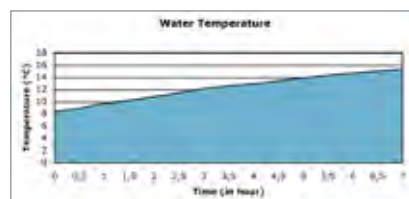

Temperatura ambiente
External temperature 20,0°

Temperatura acqua
Water temperature 7,6°

Quantità acqua inserita
Quantity of water added 7 lt

Distributore caffè Square

Coffee urn 10 lt
 Distributeur de café 10 lt
 Kaffeedispenser 10 lt
 Dispensador de café 10 lt

	cm	H cm	lt	Oz
V76 05 52 001	24x31	61	10	350



Fornelletto per scaldavivande / distributore caffè

Burner for chafing dish/coffee urn
 Porte bruleur pour chafing dish et distributeur café
 Brennstoffhalter für Chafing Dish und Kaffeedispenser
 Contenidor de combustible para chafing dish - dispensador de café

V77 05 52 FDC



Piastra elettrica per distributore caffè

Heating element for coffee urn
 Plaque électrique pour distributeur de café
 Elektro-Heizelement für Kaffeedispenser
 Plancha eléctrica para dispensador de café

	ø cm	ø in
V77 05 52 PDC	14	5,1/2

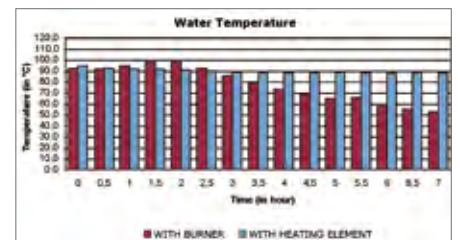

Temperatura ambiente
 External temperature 20,0°

Temperatura acqua
 Water temperature 92,5°/98,8°

Quantità acqua inserita
 Quantity of water added 8 lt

Distributore cereali singolo Square

Square cereal dispenser

Distributeur céréales Square

Mueslidispenser Square

Dispensador de cereales Square

	cm	H cm	lt	Oz
V76 05 52 010	18x27	53	4	135
V76 05 52 011	18x27	68	7	237



Tagliere per pane base acciaio Square

Square bread cutting board with St. Steel base
 Planche à découper à pain Square avec base en acier Inoxidable
 Brotschneidebrett Square mit Stahlgestell
 Tabla de cortar pan Square con base de acero Inoxidable

	cm	in
V76 05 54 001	50x30	19,5/8x11,7/8

V76 04 71 001 **50x30** **19,5/8x11,7/8**
 Solo tagliere

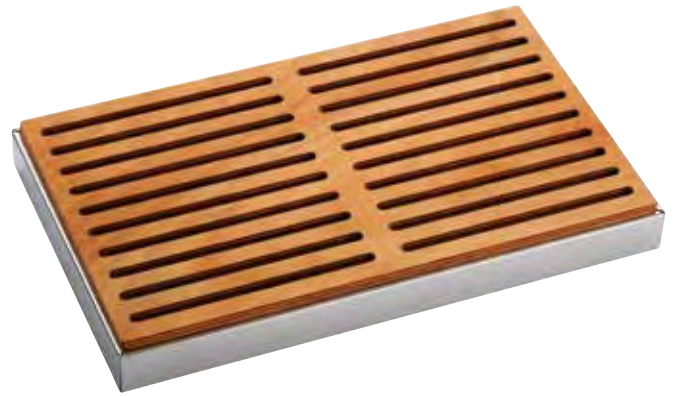

Cestino pane acciaio per buffet Square

Square bread basket for buffet, St. Steel
 Corbeille à pain en acier pour buffet Square
 Brotkorb Square für Buffet, Edelstahl
 Cesta pan en acero para buffet Square

	cm	in
V76 05 24 001	50x30	19,5/8x11,7/8



Scaldabrioche Square con termostato

Square croissant warmer
 Chauffe - croissants Square
 Croissantwärmer Square
 Calentador croissants Square

	cm	in
V76 05 52 020	47,5x28	18,3/4x11



Portamacedonia Square

Square yogurt/fruit-salad holder without lid
 Porte-salade de fruits/yogourt sans couvercle Square
 Joghurt/Obstsalatbehälter ohne Deckel Square
 Porta yogur/ensalada de frutas refrigerado sin tapa Square

	cm	in
V76 05 52 017	24x24	6,7/8x6,7/8

Con coperchio - with lid

V76 05 52 007	24x24	6,7/8x6,7/8
---------------	-------	-------------

Senza coperchio - without lid

**Coperchio metacrilato c/pomolo Square**

Acrylic lid with knob Square
 Couvercle acrylique avec pommeau Square
 Deckel aus Acryl mit Knopf Square
 Tapa acrílica con perilla Square

310 12 15 797

**Ciotola in vetro**

Glass bowl
 Bol en verre
 Glasschale
 Bol de vidrio

	ø cm	ø in
310 08 42 527	23	9

**Disco copri eutettici**

Ice pack cover
 Disc pour blocs réfrigérants
 Disco para acumuladores de frío
 Kühlakkus Scheibe

	ø cm	ø in
Z76 60 52 007	24	9,1/2

**Eutettici rettangolari**

Ice packs
 Blocs réfrigérants
 Abdeckungscheibe für Kühlakkus
 Acumuladores de frío rectangulares

V77 12 95 M00

Contenitore in metallo porta macedonia /eutettico Square

Square metal fruit salad holder 24x24 cm w/o ice pack
 Conteneur en métal pour salade de fruits sans bloc réfrigérant Square
 Metalbehälter ohne Kühlakkus Square
 Porta ensalada de frutas en metal Square sin acumuladore de frío

Z76 20 52 007



Portayogurt/marmellata refrigerato Square

Square thermal yogurt/jam holder for pitcher
 Rafrâchisseur yaourt/confiture Square
 Joghurt/Marmeladebehälter, gekühlt Square
 Portayogur/mermelada refrigerado Square

	ø cm	ø in
V76 05 52 014	15	6

Con coperchio - with lid

V76 05 52 004	15	6
---------------	----	---

Senza coperchio - without lid



Coperchio porta yogurt c/pomolo Square

Square lid with knob for yogurt holder
 Couvercle sans pomole pour porte-yaourt Square
 Deckel für Joghurtbehälter Square
 Tapa para portayogur sin perilla Square

	ø cm	ø in
Z76 01 52 004	4	1,1/2



Ciotola in vetro

Glass bowl
 Bol en verre
 Glasschale
 Bol en vidrio

	ø cm	ø in	lt	Oz
V76 08 52 004	15	6	0,5	17



Disco copri eutettici

Ice pack cover
 Disc pour blocs réfrigérants
 Kühlakkus Scheibe
 Disco para acumuladores de frío

	ø cm	ø in
Z76 60 52 005	15	6



Eutettici tondi

Round ice packs
 Blocs réfrigérants ronds
 Abdeckungscheibe für Kühlakkus
 Acumuladores de frío rectangulares

	ø cm	ø in
V77 12 95 T01	14,5	5,3/4



Contenitore in metallo porta caraffe/yogurt s/eutettico Square

Square pitcher/yogurt holder w/without ice pack
 Conteneur en métal pour carafes/yaourt sans bloc réfrigérant Square
 Metalbehälter ohne Kühlakkus Square
 Portayogur/jarra sin acumulador de frío Square

	cm	H cm	in	H in
Z76 20 52 004	17,5x17,5	7	6,7/8x6,7	3,3/4



BUFFET SQUARE

Portacaraffa con coperchio refrigerato Square

Square thermal pitcher holder with lid
 Porte-carafe avec couvercle réfrigérante Square
 Karaffenträger mit Deckel, gekühlt Square
 Soporte refrigerado para jarra con tapa Square

Acciaio Inox 18/10 - St. Steel 18/10

	lt	Oz
V76 05 52 005	1,5	50
Con coperchio-with lid		
V76 05 52 006	1,5	50
Senza coperchio-without lid		



Coperchio caraffa in acciaio per brocca

St. Steel lid for juice pitcher
 Couvercle en acier pour carafe
 Edelstahl Deckel für Karaffe
 Tapa en acero para jarra

	ø cm	ø in
Z76 01 52 005	10	4



Caraffa vetro

Glass pitcher
 Carafe en verre
 Saftkanne
 Jarra de zumo

	lt	Oz
V76 08 52 009	1,5	50
Senza coperchio-without lid		
V76 08 52 005	1,5	50
Con coperchio-with lid		



Disco copri eutettici

Ice pack cover
 Disc pour blocs réfrigérants
 Kühlakkus Scheibe
 Disco para acumuladores de frío

	ø cm	ø in
Z76 60 52 005	15	6



Eutettici tondi

Round ice packs
 Blocs réfrigérants ronds
 Kühlakkus rund
 Acumuladores de frío rectangulares

	ø cm	ø in
V77 12 95 T01	14,5	5,3/4



Contenitore in metallo porta caraffe/yogurt s/eutettico Square

Square pitcher/yogurt holder w/o ice pack
 Conteneur en métal pour carafes/yaourt sans bloc réfrigérant Square
 Metalbehälter ohne Kühlakkus Square
 Portayogurt/jarra sin acumulador de frío Square

	cm	H cm	in	H in
Z76 20 52 004	17,5x17,5	7,5	6,7/8x6,7	3



Portacaraffe con sistema refrigerante

Thermal pitcher 4-pc set
 Rafrâchisseur à 4 carafes
 Thermo-Karaffenthaler 4 Stck.
 Enfriador para 4 jarras

Acciaio Inox 18/10 - St. Steel 18/10

	cm	H cm	in	H in
V76 05 52 021	24x24	7,5	9,1/2x9,1/2	3

Caraffe non incluse - Water jugs not included



Caraffa acqua con coperchio basculante

Water glass pitcher with smart lid
 Carafe en verre avec couvercle basculant
 Wasserkaraffe
 Jarra de vidrio con tapa basculante

	lt	Oz
● V76 08 52 007	1	35
● V76 08 52 007 35	1	35
● V76 08 52 007 07	1	35

Rinfresca caraffe con sistema refrigerante

Thermal pitcher

Rafraîchisseur à carafes

Thermo-Karaffenhälter

Enfriador de botallas

Acciaio Inox 18/10 - St. Steel 18/10

	ø mm	H cm	ø in	H in
V76 055 20 23	135	5	5,3/8	2

con eutettico - with ice pack

caraffa esclusa - without pitcher

**Eutettico per rinfresca caraffe**

Ice pack for thermal pitcher

Bloc réfrigérant pour rafraîchisseur à carafes

Kühlelemente für Thermo-Karaffenhälter

Acumulador de frío para enfriador de botallas

Polietilene - Polyethylene

	ø mm	H cm	ø in	H in
V77 12 95 T02	75	2,5	3	1

**Corpo per porta caraffa**

Container for thermal pitcher

Conteneur pour rafraîchisseur à carafes

Behälter für Thermo-Karaffenhälter

Contenedor para enfriador de botallas

Polietilene - Polyethylene

	ø mm	H cm	ø in	H in
Z76 20 52 023	135	5	5,3/8	2

**Brocca ColorStyle**

ColorStyle jug

Broc à eau ColorStyle

Acryl Kanne Colorstyle

Jarra ColorStyle

Acrilico / Acrylic

	lt	Oz
<input type="checkbox"/> V60 12 08 001 13	2	70
<input checked="" type="checkbox"/> V60 12 08 001 00	2	70



Contentore alto per struttura piramidale

Container for pyramid buffet system
Conteneur haut pour structure pyramidale
Behälter für pyramidal Gestell
Contenedor alto para estructura piramidal

	cm	H cm	in	H in
V76 05 23 006	7x9,5	6	2,3/4x3,3/4	2,3/8



Cucchiaino appetizer tondo

Appetizer curved spoon
Cuillère de mise en bouche ronde pliée
Appetizer - rund gebogener Löffel
Cuchara aperitivo redonda plegada

Acciaio Inox 18/10 - St. Steel 18/10

	cm	in
903 05 81 APC	140	5,1/2



Ciotola porcellana quadra

Porcelain square bowl
Bol carré en porcelaine
Porzellanschale, viereckig
Bol cuadrado en porcelana

	cm	in
V86 21 42 CQ7	7x7	2,3/4x2,3/4



Bicchieri

Glass
Verre
Glas
Vaso

	ø cm	H cm	ø in	H in
V86 08 42 BBA	5,5	7	2,1/8	2,3/4



Struttura piramidale

completa di 5 ripiani e 3 contenitori alti.

Pyramid buffet system including 5 bases and 3 containers
Structure pyramidale complète avec 5 bases e 3 conteneurs
Pyramidal Gestell komplet bestehend von 5 Fächer und 3 hoch Behälter
Estructura piramidal completa con 5 bases y 3 contenedores

	cm	H cm	in	H in
V76 05 42 006	29,5x36,5	50	11,3/4x14,1/2	19,3/4



Piano rettangolare per struttura piramidale

Rectangular base for pyramid buffet system
Plan rectangulaire pour structure pyramidale
Rechteckig Fach für pyramidal Gestell
Base rectangular para estructura piramidal

	cm	in
V76 05 23 005	29,5x7	11,5/8x2,3/4





Un oggetto **elegante e contemporaneo**, adatto a ogni tipo di buffet: grazie al design unico e innovativo.

I materiali usati sono di **alto livello qualitativo** - acciaio Inox 18/10 e metacrilato - e rendono il distributore un oggetto pregiato.

MADE IN ITALY

La **tecnologia semplice**, ma al tempo stesso funzionale, permette di erogare dosi da 8gr (0.28 oz) di prodotto, riducendo gli sprechi ed eliminando le monoporzioni da 25gr (0.88 oz).

Questo consente un risparmio di prodotto e la riduzione dei rifiuti

nel rispetto dell'ambiente. inoltre è ideale per servire miele e marmellate di produzione artigianale, per fornire un prodotto di alto livello e che soddisfi anche i clienti più esigenti.

Un ottimo modo per arricchire l'esperienza della colazione, mantenendo **ordinato e pulito** il buffet.

Utilizzabile con prodotti erogabili semisolidi, come confetture, marmellate - pure con piccoli frammenti di frutta - e creme, ma anche con miele, sciroppi e salse di analoga consistenza.

Jambee è l'ideale per **ogni struttura ricettiva**: alberghi, pasticcerie, bar e ristoranti.



An **elegant and modern** object for all buffets, thanks to its unique and innovative design.

The materials used are **high quality** – 18/10 stainless steel and methacrylate – which makes the dispenser a fine object.

MADE IN ITALY

Its **simple technology**, though functional, allows to dispense 8 gr (0.28 oz) product doses, to reduce waste and get rid of 25 gr (0.88 oz) single dose jars.

That allows, as well, to save on product and reduce waste, respecting the environment.

Moreover, it is the ideal to dispense honey and homemade jams, in order to supply for a high-end product, capable of meeting even the most demanding customers' needs.

The best way to make the most of the breakfast experience, keeping the buffet **tidy and clean**.

It can be used with dispensable semisolid products like preserves, marmalades – even with small fruit pieces in them – , creams and honey, syrups and sauces as well, which have the same consistency. Jambee is the ideal for **any accommodation facility**: hotels, pastry shops, bars and restaurants.

**Pistone con coperchio**

Piston with lid

Piston avec couvercle

Kolben mit Deckel

Pistón con tapa

**Acciaio Inox 18/10, Metacrilato e PP
St. Steel 18/10, Methacrylate and PP**

lt

Z77 9852 DMA 0,7**Z77 9852 DMA1** 1**Contenitore**

Container

Conteneur

Behälter

Contenedor

Metacrilato - Methacrylate

lt

Z77 2052 DMA 0,7**Z77 2052 DMA1** 1**Tappo**

Cap

Capsule

Stöpsel

Tapón

Metacrilato - Methacrylate**Z77 1352 DMA****Contenitore completo**

Complete container

Conteneur complet

Komplett Behälter

Contenedor completo

Metacrilato - Methacrylate

lt

Z77 9952 DMA 0,7**Z77 9952 DMA1** 1**Targhetta porta etichetta**

Label plate

Plaque porte-étiquette

Schild Etikettenhalter

Placa porta etiqueta

Metacrilato - Methacrylate**Z77 5752 DMA****Targhetta porta etichetta**

Label plate

Plaque porte-étiquette

Schild Etikettenhalter

Placa porta etiqueta

Metacrilato - Methacrylate**Z77 5752 DMA1**

Jambee

Jambee
Jambee
Jambee
Jambee

Acciaio Inox 18/10 - St. Steel 18/10

	lt	Oz	cm	in
V77 0552 DMB	0,7	24	12,5x34,5 H Min 44,5 H Max 58	5x13,5/8 H Min 17,1/2 H Max 22,7/8
V77 0552 DMC	1	35	12,5x34,5 H Min 48 H Max 71,5	5x13,5/8 H Min 18,3/4 H Max 28,1/8



Erogatore a siringa

Syringe nozzle
Embout seringue
AusgieBerspritze
Boquilla jeringa

Acciaio Inox 18/10 - St. Steel 18/10

Z77 4652 DMA



Erogatore standard

Standard nozzle
Embout standard
Standard AusgieBer
Boquilla estandar

Acciaio Inox 18/10 - St. Steel 18/10

Z77 4552 DMA

Porta coppette linea Jambee (adatta a contenere 50 coppette)

Jambee bowl-holder with transparent bowls

Porte-bols avec bols transparents Jambee

Glasschalebehälter mit Glasschalen Jambee

Porta boles con boles transparentes Jambee

Acciaio Inox 18/10 - St. Steel 18/10

	Ø Cm	H. Cm	Ø In	H. In
V77 05 09 C01	15	26,5	5,9	10,3/8

**Coppetta per marmellata**

Jam bowl

Bol pour marmelade

Marmeladeschale

Bol para marmelada

Vetro - Glass

	Ø Cm	Ø In
V77 08 09 001	6	2,3/8







Portaformaggi/affettati rettangolare completo

Rectangular cheese dish
 Plateau fromage-charcuterie rectangulaire
 Käse/Wurstwarenplatte - rechteckig
 Quesera rectangular

	cm	H cm	in	H in
V77 05 54 G11	53x32,5	18	20,7/8x12,3/4	7

**Coperchio a bascula trasparente**

Transparent rolltop cover
 Cloche basculante transparente
 Rolltophaube
 Campana rolltop transparente

	cm	in
V77 12 15 G11	47x27	18,1/2x10,5/8

**Vassoio gastronorm**

Gastronorm tray
 Plateau gastronorm
 Gastronorm Platte
 Bandeja gastronorm

Acciaio Inox 18/10 - St. Steel 18/10

	cm	in
V01 05 23 G11	53x32,5	20,7/8x12,3/4

**Tagliere rettangolare**

Rectangular cutting board
 Planche rectangulaire
 Rechteckig-Schneidebrett
 Tabla para cortar rectangular

Polietilene - Polyethylene

	cm	in	Sp. mm	Th. in
V77 12 71 G11	47x27	18,1/2x10,5/8	1,5	0,5/8

Portaformaggi/affettati tondo completo

Round cheese dish

Plateau fromage-charcuterie rond

Käse/Wurstwarenplatte - rund

Quesera redonda

	ø cm	H cm	ø in	H in
V77 05 54 T46	46	24,5	18,1/8	9,5/8

**Coperchio a bascula tondo trasparente**

Transparent round rolltop cover

Cloche basculante ronde transparente

Rolltophaube - rund

Campana rolltop redonda transparente

	ø cm	ø in
V77 12 15 T46	41	16,1/8

**Vassoio tondo bar**

Round bar tray

Plateau rond bar

Platte - rund

Bandeja redonda bar

Acciaio Inox 18/10 - St. Steel 18/10

	ø cm	ø in
V01 05 23 T46	46 cm	18,1/8

**Tagliere tondo**

Round cutting board

Planche ronde

Schneidebrett - rund

Tabla para cortar redonda

Polietilene - Polyethylene

	cm	in	Sp. mm	Th. in
V77 12 71 T46	41	16,1/8	2	0,3/4

Portaformaggi/affettati rettangolare completo refrigerato con base in acciaio

Thermal rectangular cheese dish

Plateau fromage-charcuterie rectangulaire réfrigéré

Käse/Wurstwarenplatte - rechteckig

Quesera rectangular refrigerante

	cm	H cm	in	H in
V77 05 54 G11 R	53x32,5	19	20,7/8x12,3/4	7,1/2

**Coperchio a bascula rettangolare trasparente**

Transparent rectangular rolltop cover

Cloche basculante rectangulaire transparente

Rolltophaube-rechteckig

Campana rectangular transparente

	cm	in
V77 12 15 G11	47x27	18,1/2x10,5/8

**Tagliere rettangolare**

Rectangular cutting board

Planche à découper rectangulaire

Rechteckiges Schneidebrett

Tabla de cortar rectangular

Polietilene - Polyethylene

	cm	in	Sp. mm	Th. in
V77 12 71 G11	47x27	18,1/2x10,5/8	1,5	0,5/8

**Bacinella rettangolare**

Rectangular pan

Cuvette rectangulaire

Schüssel - rechteckig

Cubeta rectangular

Acciaio Inox 18/10 - St. Steel 18/10

	cm	H cm	in	H in
V77 05 14 G11	53x32,5	3,5	20,7/8x12,3/4	1,1/8

**8 Eutettici rettangolari**

8 Ice packs

8 Blocs réfrigérants

8 Kühlakkus

8 Acumuladores de frío rectangulares

V77 12 95 P00

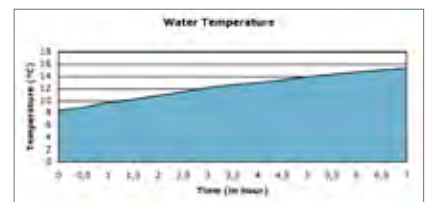

Temperatura ambiente
External temperature 19,6°

Temperatura acqua
Water temperature 18,9°

Mezzo refrigerante
Cooler system 8 eutettici ghiaccio piccoli
8 small ice pack

Portaformaggi/affettati tondo completo refrigerato con base in acciaio

Thermal round cheese dish

Plateau fromage-charcuterie rond réfrigéré

Käse/Wurstwarenplatte - rund

Quesera redonda refrigerante

	cm	H cm	in	H in
V77 05 54 T46 R	46	27,5	18,1/8	10,7/8



Coperchio a bascula tondo trasparente

Transparent round rolltop cover

Cloche basculante ronde transparente

Rolltophaube - rund

Campana redonda transparente

	ø cm	ø in
V77 12 15 T46	41	16,1/8



Tagliere tondo

Round cutting board

Planche ronde

Schneidebrett - rund

Tabla para cortar redonda

Polietilene - Polyethylene

	ø cm	ø in	Sp. mm	Th. in
V77 12 71 T46	41	16,1/8	2	0,3/4



Bacinella tonda

Round pan

Cuvette ronde

Schüssel - rund

Cubeta redonda

Acciaio Inox 18/10 - St. Steel 18/10

	ø cm	H cm	ø in	H in
V77 05 14 T46	46	5	18,1/8	2



4 Eutettici rettangolari

4 Ice packs

4 Blocs réfrigérants

4 Kühlakkus

4 Acumuladores de frío rectangular

V77 12 95 G00

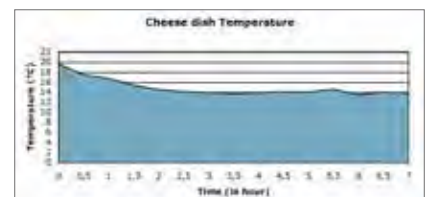

Temperatura ambiente
External temperature 20,9°

Temperatura acqua
Water temperature 19,5°

Mezzo refrigerante
Cooler system 4 eutettici ghiaccio piccoli
4 small ice pack

Scaldavivande rettangolare con coperchio rotante

Rectangular rolltop chafing dish
Chafing dish rectangulaire avec couvercle pivotant
Chafing Dish - rechteckig mit Rolltophaube
Calientaplatos rectangular con campana

Acciaio Inox 18/10 - St. Steel 18/10

	GN	cm	H cm	in	H in
V77 05 52 CHR	1/1	65,5x48	44	25,3/4x19	17,3/8

Imperial scaldavivande rettangolare con coperchio rotante

Imperial rectangular chafing dish
Chafing dish rectangulaire Imperial
Chafing dish rectangular Imperial
Chafing Dish rechteckig Imperial

Acciaio Inox 18/10 - St. Steel 18/10

	GN	cm	H cm	in	H in
V77 05 52 CHR	1/1	65,5x48	44	25,3/4x19	17,3/8

Imperial scaldavivande rettangolare con coperchio rotante inox

Imperial rectangular chafing dish
Chafing dish rectangulaire Imperial
Chafing dish rectangular Imperial
Chafing Dish rechteckig Imperial

Acciaio Inox 18/10 - St. Steel 18/10

	GN	cm	H cm	in	H in
V77 05 52 CHR	1/1	65,5x48	44	25,3/4x19	17,3/8

Con:

Coperchio rotante a scomparsa
Portavivande 1/1 Gastronorm
2 bruciatori per pasta - combustibile
Predisposto per piastra elettrica

With:

Rolltop
1/1 gastronorm food pan
2 solid fuel burners.
Electric heating element
(available as optional)

**Fornelletto per scaldavivande**

Chafing-dish burner
Porte-brûleur pour chafing dish
Brennstoffhalter für Chafing Dish
Contenedor de combustible para chafing dish

V77 05 52 FDC**Piastra elettrica per scaldavivande**

Heating element for chafing-dishes
Plaque électrique réchauffeur chafing dish
Elektro - Heizelement für Chafing Dish
Plancha eléctrica para calienta platos

	V	W	Hz
V77 05 52 PCR	220	500	50

V77 05 52 PCR1 230 250
Con regolatore With power regulator

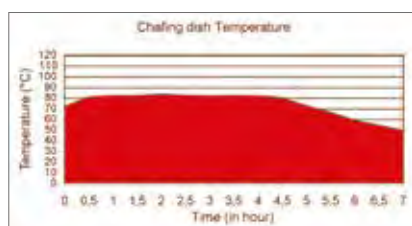
Con fornelli*Whit burners*

Temperatura ambiente External temperature	20,3°
Temperatura acqua Water temperature	94°
Quantità acqua inserita Quantity of water added	6 lt.
Fonte di calore Heat source	2 fornelli a fiamma 2 burners

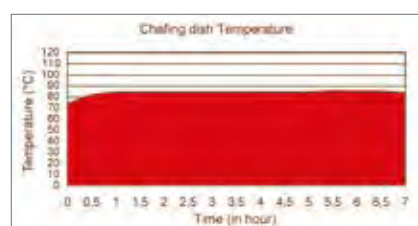
Con piastra elettrica*Whit heating element*

Temperatura ambiente External temperature	20,3°
Temperatura acqua Water temperature	94°
Quantità acqua inserita Quantity of water added	6 lt.
Fonte di calore Heat source	piastra elettrica heating element

Scaldavivande tondo con coperchio rotante

Round rolltop chafing dish
Chafing dish rond avec couvercle pivotant
Chafing Dish - rund mit Rolltophaube
Calientaplatos redondo con campana

Acciaio Inox 18/10 - St. Steel 18/10

	ø cm	H cm	ø in	H in
V77 05 52 CHT	50	46	15,3/4	18,1/8

Con:

Coperchio rotante a scomparsa
Portavivande ø 40 cm
1 bruciatore per pasta - combustibile
Predisposto per piastra elettrica

With:

Rolltop
Food pan ø 40 cm
Solid fuel burners.
Electric heating element
(available as optional)



Fornelletto per scaldavivande

Chafing-dish burner
Porte-brûleur pour chafing dish
Brennstoffhalter für Chafing Dish
Contenedor de combustible para chafing dish

V77 05 52 FDC



Piastra elettrica per scaldavivande

Heating element for chafing-dishes
Plaque électrique réchauffeur chafing dish
Elektro - Heizelement für Chafing Dish
Plancha eléctrica para calienta platos

	V	W	Hz
V77 05 52 PCT	220	500	50

V77 05 52 PCT1 230 250
Con regolatore With power regulator

Con fornelli

Whit burners

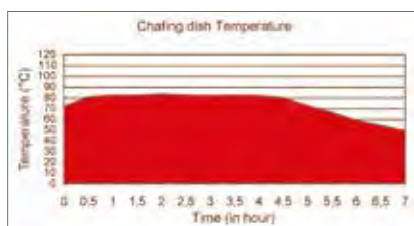

Temperatura ambiente External temperature	20,3°
Temperatura acqua Water temperature	94°
Quantità acqua inserita Quantity of water added	6 lt.
Fonte di calore Heat source	2 fornelli a fiamma 2 burners

Con piastra elettrica

Whit heating element

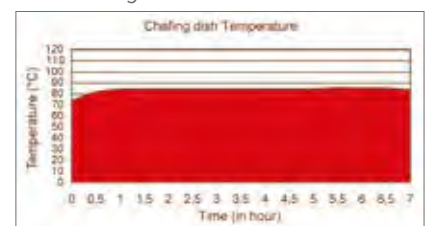

Temperatura ambiente External temperature	20,3°
Temperatura acqua Water temperature	94°
Quantità acqua inserita Quantity of water added	6 lt.
Fonte di calore Heat source	piastra elettrica heating element

Portavivande in porcellana

Food pan, porcelain
Bac en porcelaine
Porzellanbehälter
Cubeta de porcelana

	GN	cm	in
V01 21 52 G11B	1/1	53x32,5x6,5	20,7/8x12,3/4x2,1/2
V01 21 52 G23B	2/3	35,3x32,5x6,5	13,3/4x12,3/4x2,1/2
V01 21 52 G12B	1/2	26,5x32,5x6,5	10,3/8x12,3/4x2,1/2
V01 21 52 G13B	1/3	17,6x32,5x6,5	6,7/8x12,3/4x2,1/2

**Portavivande tondo in porcellana**

Round food pan, porcelain
Bac rond en porcelaine
Porzellanbehälter, rund
Cubeta redonda de porcelana

	ø cm	ø in
V01 21 52 T40	40	15,3/4

**inserto scaldavivande tondo in porcellana**

Food pan half round chafing dish, porcelain with divider
Bac double en porcelaine pour chafing dish rond
Porzellaninsatz, 2tlg für Chafing Dish
Cubeta avec separation de porcelana para chafing dish redondo

	ø cm	ø in
V01 21 71 T12 (1 pz.)	40 cm	15,3/4

**Set zuppiere per scaldavivande tondo**

Soup tureen set for cm. 40 round chafing dish
Set de soupières pour chafing dish rond
Suppenschüssel für Chafing Dish rund
Set de soperas para chafing dish redondo

Acciaio Inox 18/10 - St. Steel 18/10

	ø cm	ø in	lt	Oz
V77 05 52 ACT	40	15,3/4	4,2	142

**Set minstre per scaldavivande rettangolare**

Soup tureen set for rectangular chafing dish
Set de soupières pour chafing dish rectangulaire
Suppenschüssel für Chafing Dish rechteckig
Set de soperas para chafing dish rectangular

Acciaio Inox 18/10 - St. Steel 18/10

	GN	lt	Oz
V77 05 52 ACR	1/1	4,2	142



Porta cereali girevole a 3 comparti*

Triple rotating cereal holder
 Distributeur céréales pivotant à 3 compartiments
 Büffet-Ständer - drehbar mit 3 Glasschalen
 Dipensador de cereales giratorio 3 sectores

Acciaio Inox 18/10 - St. Steel 18/10

	ø cm	ø in
V77 05 52 CER 3	42	16,1/2



Porta cereali girevole a 6 comparti*

6-dish rotating cereal holder
 Distributeur céréales pivotant à 6 compartiments
 Büffet-Ständer - drehbar mit 6 Glasschalen
 Dipensador de cereales giratorio 6 sectores

Acciaio Inox 18/10 - St. Steel 18/10

	ø cm	ø in
V77 05 52 CER	42	16,1/2 in



*Sono escluse le ciotole in vetro
 *Without glass bowls

Ciotola in vetro

Glass bowl
 Bol en verre
 Glasschale
 Bol de vidrio

	ø cm	ø in	lt	Oz
310 08 42 527	23	9	1,3	60



Coperchio in metacrilato

Acrylic lid
 Couverture acrylique
 Deckel aus Metakryl
 Tapa acrílica

	ø cm	ø in
310 12 15 795	23	9

Con pomolo in metacrilato - With acrylic knob

310 12 15 790	23	9
---------------	----	---

Con pomolo in acciaio Inox - With St. Steel knob



Distributore cereali girevole a 3 comparti con base in acciaio

Triple rotating cereal dispenser with stainless steel base

Distributeur céréales pivotant à 3 compartiments avec base en acier Inoxidable

3-Müslidispenser-drehbar mit Stahlboden

Dispensador de cereales giratorio 3 sectores con base de acero Inoxidable

Acciaio Inox 18/10 - St. Steel 18/10

V77 05 52 CD6	42	∅ cm	H cm ∅ in	H in	lt	Oz
		60	16,1/2	23,5/8	3 (x3)	101 (x3)

Con:

Contentore removibile

Pomolo in metallo

Spazzola interna

Girandola dosatrice

With:

Removable container

Metal knob

inner brush

Doser handle

**Contentore removibile**

Consente di riempirlo e pulirlo facilmente

Removable container

It allows to be filled in and cleaned easily

**Spazzola interna**

non rompe i cereali

inner brush

that does not break cereals

**Dettaglio pomolo in metallo**

Detail of metal knob

**Girandola dosatrice**

Doser handle



Distributore cereali singolo con base in acciaio

Single cereal dispenser with stainless steel base

Distributeur céréales individuel avec base en acier Inoxidable

Müslidispenser mit Stahlboden

Dispensador de cereales individual con base de acero Inoxidable

Acciaio Inox 18/10 - St. Steel 18/10

	cm	H cm	in	H in	lt	Oz
V77 05 52 CD4	31x21	60	12,1/4x8,1/4	23,5/8	3	101



Distributore cereali a 2 comparti con base in acciaio

Double cereal dispenser with stainless steel base

Distributeur céréales à 2 compartiments avec base en acier Inoxidable

2-Müslidispenser mit Stahlboden

Dispensador de cereales 2 sectores con base de acero Inoxidable

Acciaio Inox 18/10 - St. Steel 18/10

	cm	H cm	in	H in	lt	Oz
V77 05 52 CD5	37,5x24,5	60	14,3/4x9,5/8	23,5/8	3 (x2)	101 (x2)



Portayogurt

Yogurt tray
 Plateau porte-yogourt
 Joghurtplatte
 Bandeja yogur

Acciaio Inox 18/10 - St. Steel 18/10

	ø cm	ø in	H cm	H in
V77 05 52 T46	46	18,1/8	5	2



Portaburro/crostacei

Butter tray
 Plateau porte-beurre/crustacés
 Butter/Krustazeenplatte
 Bandeja mantequilla

Acciaio Inox 18/10 - St. Steel 18/10

	ø cm	ø in	H cm	H in
V77 05 09 T32	32	12,5/8	5	2
V77 05 09 T46	46	18,1/8	5	2



Tagliere per pane con base acciaio

Bread cutting board
 Planche à découper à pain
 Tabla de cortar pan
 Brotschneidebrett

	cm	H cm	in	H in
V01 05 54 004	53x32,5	3,5	20,7/8x12,3/4	1,1/8



Cestino portabrioche tondo con cloche basculante

Round croissant basket with rolltop cover

Corbeille ronde à viennoiseries avec cloche basculante

Büffetkorb - rund mit Rolltophaube

Cesta de buffet redonda con campana roll top

Rattan

	ø cm	ø in	Hcm	H in
V77 04 52 T44	44	17,3/8	35	13,3/4



Coperchio a bascula tondo trasparente

Transparent round rolltop cover

Cloche basculante ronde transparente

Rolltophaube - rund

Campana redonda roll top transparente

	ø cm	ø in
V77 12 15 T46	41	16,1/8



Cestino rattan

Rattan basket

Corbeille rottin

Rattankorb

Cesta ratán

	ø cm	ø in
V77 04 24 T44	41	17,3/8

interno rotondo in adatto al contatto con gli alimenti

inside base for rattan round croissant basket. Suitable for food contact

Revêtements intérieurs, apte au contacte alimentaire

innenverkleidung Lebensmittel geeignet

Forro interior, apto para alimentos

Polistirene

	ø cm	ø in	H cm	H in
Z77 46 52 T44	41	14,1/8	11	4,3/8

Cestino portabrioche rettangolare con cloche basculante

Rattan rectangular croissant basket with rolltop cover
 Corbeille rectangulaire à viennoiseries avec cloche basculante
 Büffetkorb - rechteckig mit Rolltophaube
 Cesta de buffet rectangular con campana roll top

Rattan

	cm	in	H cm	H in
V77 04 52 R50	50x29,5	19,3/4x11,5/8	29,5	11,5/8



Coperchio a bascula rettangolare trasparente

Transparent rectangular rolltop cover
 Cloche basculante rectangulaire transparente
 Rolltophaube - rechteckig
 Campana roll top rectangular transparente

	cm	in
V77 12 15 G36	37x21	14,1/2x8,1/4
V77 12 15 G11	47x27	18,1/2x10,5/8



Cestino rattan

Rattan basket
 Corbeille rottin
 Rattankorb
 Cesta ratán

	cm	in
V77 04 24 R39	38,5x23	15,1/8x9
V77 04 24 R50	50x29,5	19,3/4x11,5/8

interno rettangolare adatto al contatto con gli alimenti

inside base for rattan rectangular croissant basket. Suitable for food contact
 Revêtements intérieurs, apte au contacte alimentaire
 innenverkleidung Lebensmittel geeignet
 Forro interior para cestas de buffet, apto para alimentos

Polistirene

	ø cm	ø in	H cm	H in
Z77 46 52 R50	50x27	15x7,5/8	11	4,3/8

Coperchio in metacrilato

Acrylic lid
Couvercle acrylique
Deckel Acryl
Tapa acrílica

	ø cm	ø in
310 12 15 795	23	9

Con pomolo in metacrilato - With acrylic knob

310 12 15 790	23	9
----------------------	-----------	----------

Con pomolo in acciaio Inox - With St. Steel knob

**Ciotola in vetro**

Glass bowl
Bol en verre
Glasschale
Bol de vidrio

	ø cm	ø in	Hcm	H in
310 08 42 527	23	9	10,5	4,1/8



**Rinfrescamacedonia/yogurt
con contenitore ghiaccio esterno con coperchio**

Fruit-salad/yogurt cooler with outer ice container and lid

Rafraîchisseur salade de fruits/yogourt avec récipient à glace externe et couvercle

Joghurt/Obstsalatbehälter mit Eisbehälter außen und mit Deckel

Portaensalada de frutas/yogur refrigerado con recipiente para hielo externo y tapa

Metacrilato

	∅ int. cm	∅ int. in	∅ est. cm	∅ est. in
V77 05 43 YOG 2	23	9	26	10,1/4



**Rinfrescamacedonia/yogurt
con contenitore ghiaccio esterno in acciaio con coperchio**

Fruit-salad/yogurt cooler with outer ice container and lid

Rafraîchisseur salade de fruits/yogourt avec récipient à glace externe avec couvercle

Joghurt/Obstsalatbehälter mit Edelstahl - Eisbehälter außen mit Deckel

Portaensalada de frutas/yogur refrigerado con recipiente para hielo externo con tapa

Acciaio Inox - St. Steel

	∅ int. cm	∅ int. in	∅ est. cm	∅ est. in
V77 05 43 YOG	23	9	28	11



Distributore caffè con rubinetto in metallo

Coffee urn

Distributeur café

Kaffeedispenser

Dispensador de café

Acciaio Inox 18/10 - St. Steel 18/10

	ø cm	ø in	H cm	H in	lt	Oz
V77 05 52 DCA	21	8,4	54	21,1/4	7	237
V77 05 52 DCA 1	21	8,4	62	24,3/8	10	350

**Rubinetto in metallo**

Metal tap

Robinet en métal

Metallhahn

Grifo de metal

Z77 18 52 OTT

**Piastra elettrica per distributore caffè**

Heating element for coffee urns

Plaque électrique pour distributeur de café

Elektro-Heizelement für Kaffeedispenser

Plancha eléctrica para dispensadores de café

	ø cm	ø in
V77 05 52 PDC	14	5,1/2

**Fornelletto per scaldavivande/distributore caffè**

Burner for chafing dishes-coffee urns

Porte bruleur pour chafing dish et distributeur café

Brennstoffhalter für Chafing Dish und Kaffeedispenser

Contenedor de combustible para chafing dish - dispensadores de café

V77 05 52 FDC

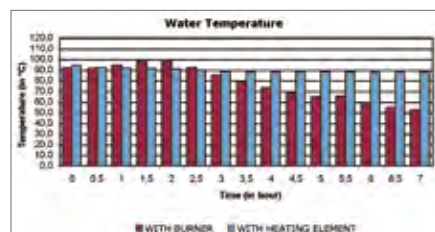
Temperatura ambiente
External temperature

20,0°

Temperatura acqua
Water temperature

92,5°/98,8°

Quantità acqua inserita
Quantity of water added

8 lt

Distributore succhi

Juice dispenser
Distributeur jus
Saftdispenser
Dispensador de zumo

Acciaio Inox 18/10 - St. Steel 18/10



Con rubinetto in metallo

With metal tap
Avec robinet en métal
Mit Metallhahn
Con grifo de metal

	cm	H cm	lt
V77 05 52 DSM	25x35	66	8
	in	H in	Oz
	9,7/8x13,3/4	26	270

Rubinetto in metallo

Metal tap
Robinet en métal
Metal- Holzständer
Grifo de metal

Z77 18 52 OTT



Con rubinetto in plastica

With plastic tap
Avec robinet en plastique
Mit Kunststoffhahn
Con grifo de plástico

	cm	H cm	lt
V77 05 52 DSU	25x35	66	8
	in	H in	Oz
	9,7/8x13,3/4	26	270

Rubinetto in plastica nero

Black plastic tap
Robinet en plastique noir
Plastikhahn, Schwarz
Grifo de plástico negro

Z77 18 52 POL



Contentore trasparente

Transparent container
Récipient transparent
Durchsichtbare Behälter
Contenedor transparente

	lt	Oz
Z77 63 52 000	8	270



Eutettici tondi

Round ice packs
Blocs réfrigérants
Kühlakkus
Acumuladores de frío rectangulares

V77 12 95 T01



Supporto refrigerato per caraffe succhi con vassoio portabicchieri*

Thermal stand for juice pitchers with glasses tray*

Support réfrigéré pour carafes jus avec plateau porte-verres

Saftkaraffenständer gekühlt mit Gläserständer

Soporte refrigerante para jarras zumo con bandeja para vasos

Acciaio Inox 18/10 - St. Steel 18/10

	ø cm	ø in	H cm	H in
V77 05 52 SUC			67	26,3/8
Base	41,5	16,3/8		
Alzata - Holder	38,5	15,1/8		
Sede caraffa - Pitcher seat	16,4	6,1/2		

Supporto refrigerato per caraffe succhi*

Thermal stand for juice* pitchers

Support réfrigéré pour carafes jus

Saftkaraffenständer gekühlt

Soporte refrigerante para jarras zumo

Acciaio Inox 18/10 - St. Steel 18/10

	ø cm	ø in	H cm	H in
V77 05 52 SUS			36	14,1/8
Base	41,5	16,3/8		
Sede caraffa - Pitcher seat	16,4	6,1/2		



Disco coprietettici per supporto refrigerante per caraffe

Plate for thermal stand for juice pitchers (to cover ice packs)

Plaque couvre-blocs réfrigérants pour support réfrigéré pour carafes

Deckel für Kühlelemente zum Karaffenbehälter

Placa cubre acumuladores de frío para soporte refrigerante para jarras

	ø cm	ø in
PRV 1A SU CAD S0	41	16,1/8

*Sono escluse le caraffe in vetro

*Without pitchers

Caraffa succhi

Juice pitcher
Carafe jus
Saftkanne
Jarra zumo

	lt	Oz
V76 08 52 005	1,5	51

Con coperchio in metallo - with metal lid 18/10

V76 08 52 009	1,5	51
---------------	-----	----

Senza coperchio - without lid



Coperchio in acciaio 18/10

Stainless steel lid
Couvercle en acier 18/10
Deckel aus Edelstahl
Tapa de acero Inoxidable

Acciaio Inox 18/10 - St. Steel 18/10

Z76 01 52 005



Caraffa termica 18/10

Thermal beverage serve
Carafe thermos avec anse
Thermische Karaffe
Jarra térmica

Acciaio Inox 18/10 - St. Steel 18/10

	Cl	Oz
V01 05 08 T06	75	26
V01 05 08 T10	100	35
V01 05 08 T15	150	51
V01 05 08 T20	200	68



75 Cl - 26 Oz

Temperatura ambiente 19,6°
External temperature

Temperatura acqua 94°
Water temperature

Quantità acqua inserita 60 cl.
Quantity of water added

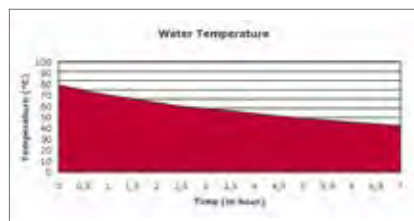

100 Cl - 35 Oz

Temperatura ambiente 19,6°
External temperature

Temperatura acqua 94°
Water temperature

Quantità acqua inserita 90 cl.
Quantity of water added

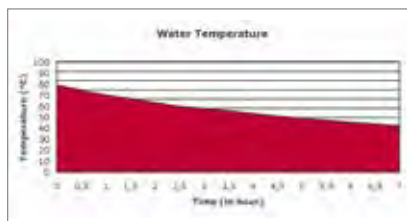

150/200 Cl - 53/70 Oz

Temperatura ambiente 20,9°
External temperature

Temperatura acqua 95°
Water temperature

Quantità acqua inserita 150 cl.
Quantity of water added

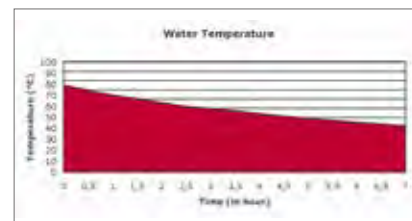

Alzata torta

Cake stand
Presentoir à gâteau
Tortenplatte
Soporte tarta

Acciaio Inox 18/10 - St. Steel 18/10

	ø cm	ø in	H cm	H in
V01 05 42 022	22	8,5/8	9,5	3,3/4
V01 05 42 032	32	12,5/8	12,5	12,5
V01 05 42 042	42	16,1/2	16,5	6,1/2

**Alzata torta 3 piani**

3-tier cake stand
Présentoir à gâteau 3 étages
Kuchenständer 3-stufig
Soporte tarta con 3 pisos

Acciaio Inox 18/10 - St. Steel 18/10

	ø cm	ø in	H cm	H in
V01 05 42 301	22/32/42	8,5/8-12,5/8-16,1/2	43,5	17,1/8

**Alzata frutta 3 piani**

3-tier fruit stand
Serviteur à fruits 3 étages
Obstständer 3-stufig
Frutero con 3 pisos

Acciaio Inox 18/10 - St. Steel 18/10

	ø cm	ø in	H cm	H in
V77 05 42 326	22/29/36,5	8,5/4-11,3/8-14,3/8	44	17,3/8



Piatto torta con coperchio a bascula

Cake tray with roll top cover
 Plateau à gâteaux avec cloche basculante
 Kuchenplatte mit Rolltopphaube
 Plato para tartas con campana roll top

Acciaio Inox 18/10 - St. Steel 18/10

	ø cm	ø in
V76 05 42 003	38	15

Coperchio a bascula tondo trasparente

Transparent round rolltop cover
 Cloche basculante ronde transparente
 Rolltopphaube - rund
 Campana redonda transparente

SAN

	ø cm	ø in
V76 12 15 T01	34	13,3/8



Alzata torta con coperchio a bascula

Cake stand with roll top cover
 Présentoir à gâteaux avec cloche basculante
 Kuchenplatte mit Schaukeldeckel
 Soporte para tartas con campana roll top

Acciaio Inox 18/10 - St. Steel 18/10

	ø cm	H cm	ø in	H in
V76 05 42 002	38	12,5+32	15	4,7/8 + 12,5/8



Vassoio torta con cupola Basic

Basic cake tray with dome
 Plateau à gâteau avec cloche Basic
 Kuckenplatte mit Basic
 Plato para tartas con campana Basic

Acciaio Inox 18/10 - St. Steel 18/10

Polycarbonato - polycarbonate

	ø cm	ø in
V01 05 42 T32	32	12,5/8



Portabrioches singolo

Croissant tray

Plateau porte-croissants

Brot Büfettkorb

Bandeja de buffet

base pp - coperchio san**tray pp - lid san**

	cm	in	H cm	H in
V77 12 52 01P	50x30,5	19,5/8x12,1/8	18,5	7,1/4
V77 12 52 03P	40x24,5	15,3x9,5/8	15,5	6,1/8

**Portabrioches doppio**

Double-deck croissant tray

Porte-croissants deux étages

Doppelsplatte Brot Büfettkorb

Bandeja de buffet con dos pisos

base pp - coperchio san**tray pp - lid san**

	cm	in	H cm	H in
V77 12 52 02P	50x30,5	19,5/8x12,1/8	39	15,3/8

**Portabrioches tondo**

Round croissant tray

Porte-croissants rond

Brot Büfettkorb rund

Bandeja de buffet redonda

base pp - coperchio san**tray pp - lid san**

	ø cm	ø in
V77 12 52 0TP	46	18,1/8
V77 12 52 0TP1	38	15



Portaformaggi/affettati refrigerato singolo

Thermal food tray rectangular
 Porte-dîner rectangulaire réfrigérant individuel
 Wurstwarenplatte, rechteckig
 Bandeja portaquesos/embutidos rectangular refrigerante individual

base pp - coperchio san
tray pp - lid san

	cm	in	H cm	H in
V77 12 54 01P	50x30,5	19,5/8x12,1/8	18,5	7,1/4



Portaformaggi/affettati refrigerato doppio

Thermal food tray rectangular, double
 Porte-dîner rectangulaire réfrigérant double
 Doppelwurstwarenplatte, rechteckig
 Bandeja portaquesos rectangular refrigerante doble

base pp - coperchio san
tray pp - lid san

	cm	in	H cm	H in
V77 12 54 02P	50x30,5	19,5/8x12,1/8	39	15,3/8



Eutettici rettangolari

Ice packs
 Blocs réfrigérants
 Kühllakkus
 Acumuladores de frío rectangulares

V77 12 95 G00



Base coprieutettici per portaformaggi refrigerato

Ice pack cover for termale rectangular cheese dish
 Base couvre blocs réfrigérants pour porte-dimer réfrigérant
 Kühllakkus scheinbe fur Wurstwaremplate, rechteckig
 Base para acumuladores de frío para bandeja portaquesos refrigerante

Acciaio Inox 18/10 - St. Steel 18/10

	cm	in
Z77 19 54 01P	43,5x24	17,1/8x9,1/2

abert

Combina i diversi elementi per personalizzare il tuo carrello. Design lineare ed eleganza dal sapore naturale sono i tratti distintivi di questa linea: una proposta di carrelli da comporre a piacimento, mixando gli elementi standard per un servizio unico e su misura.

Combine the different elements to customise your trolley. Linear design and natural elegance are the distinguishing features of this line: a range of trolleys that you can compose as you wish, by mixing the standard elements for a bespoke and unique service.

Carrello Gueridon

Gueridon trolley
Chariot Guéridon
Carro Gueridon
Servierwagen Gueridon

	Cm	Colore / Color
 V42 04 51 001	90x50 h.80	Rovere chiaro / Light oak
 V42 04 51 002	90x50 h.80	Rovere scuro / Dark oak





Carrello LUX con due cassetti

LUX trolley, 2-drawer

Chariot LUX avec tiroir

Carro LUX con cajón



Servierwagen LUX, 2 Schubladen

	Cm	Colore / Color
 V42 04 51 003	90x50 h.80	Rovere chiaro / Light oak
 V42 04 51 004	90x50 h.80	Rovere scuro / Dark oak



Top dolci / formaggi refrigerato

Dessert/cheese top, refrigerated
 Etagère dessert/fromages réfrigéré
 Bandeja postres/quesos refrigerado
 Dessert/Käse-Top; gekühlt

	Cm	Colore / Color
 V42 04 51 T05	90x50 h.28	Rovere chiaro / Light oak
 V42 04 51 T06	90x50 h.28	Rovere scuro / Dark oak

Carrello Gueridon

Gueridon trolley
 Chariot Guéridon
 Carro Gueridon
 Servierwagen Gueridon

	Cm	Colore / Color
 V42 04 51 001	90x50 h.80	Rovere chiaro / Light oak
 V42 04 51 002	90x50 h.80	Rovere scuro / Dark oak





Top bar con ringhiera 90x50

Bar top with railing 90x50
 Etagère bar a/barrière 90x50
 Bandeja bar c/barandilla 90x50
 Bar-Top mit Umrandung 90x50

	Cm	Colore / Color
 V42 04 51 T03	90x50 h.10,5	Rovere chiaro / Light oak
 V42 04 51 T04	90x50 h.10,5	Rovere scuro / Dark oak

Carrello LUX con due cassetti

LUX trolley, 2-drawer
 Chariot LUX avec tiroir
 Carro LUX con cajón
 Servierwagen LUX, 2 Schubladen

	Cm	Colore / Color
 V42 04 51 003	90x50 h.80	Rovere chiaro / Light oak
 V42 04 51 004	90x50 h.80	Rovere scuro / Dark oak

Carrello bar / liquori

Bar/liquor trolley
Chariot bar/liqueurs
Carro bar/licores
Bar/Likör-Wagen

	Cm	Colore / Color
 V42 04 51 015	90x50 h.90,5	Rovere chiaro / Light oak
 V42 04 51 016	90x50 h.90,5	Rovere scuro / Dark oak





Carrello dolci / formaggi refrigerato

Dessert/cheese trolley, refrigerated

Chariot dessert/fromages réfrigéré

Carro postres/quesos refrigerado

Dessert/Käse-Wagen; gekühlt

	Cm	Colore / Color
 V42 04 51 013	90x50 h.108	Rovere chiaro / Light oak
 V42 04 51 014	90x50 h.108	Rovere scuro / Dark oak



Accessori per foro

Hole accessories

Vasca ghiaccio Acciaio 18/10

Ice pan/champagne bucket 18/10 St.Steel

Bac à glace Acier 18/10

Cubeta de hielo Acero 18/10

Eispanne / Champagnerkühler, Edelstahl 18/10

V42 05 51 006 43x40 h. 16 Cm**Scaldavivande GN 2/3**

Chafing dish GN 2/3

Chafing dish empotr GN 2/3

Chafing dish empotrable GN 2/3

Chafing-Dish GN 2/3

305 05 52 695 Coperchio in acciaio / St. Steel lid**305 05 52 694 Coperchio in vetro / Glass lid****Piastra a induzione c/supporto inox 18/10**

Induction plate + steel counter top 18/10 St.steel

Plaque à induction a/support Acier 18/10

Placa de inducción c/soporte Acero 18/10

Induktionsplatte und Arbeitsplatte, Edelstahl 18/10

V42 05 51 002 84x40,5 h.7 Cm**Accessori ad incastro sulle ringhiere**

Interlocking accessories on railings

Porta bottiglie / glacette

Bottle/bottle-cooler holder

Porte-bouteilles/glacette

Porta botellas/enfriador botellas

Flaschen-/Flaschenkühlerhalter

V42 05 51 003 46x17 h.1,6 Cm**Porta sorbettiere**

Sherbet-pot holder

Support sorbetières

Porta sorbeteras

Sorbet-Topf Stand

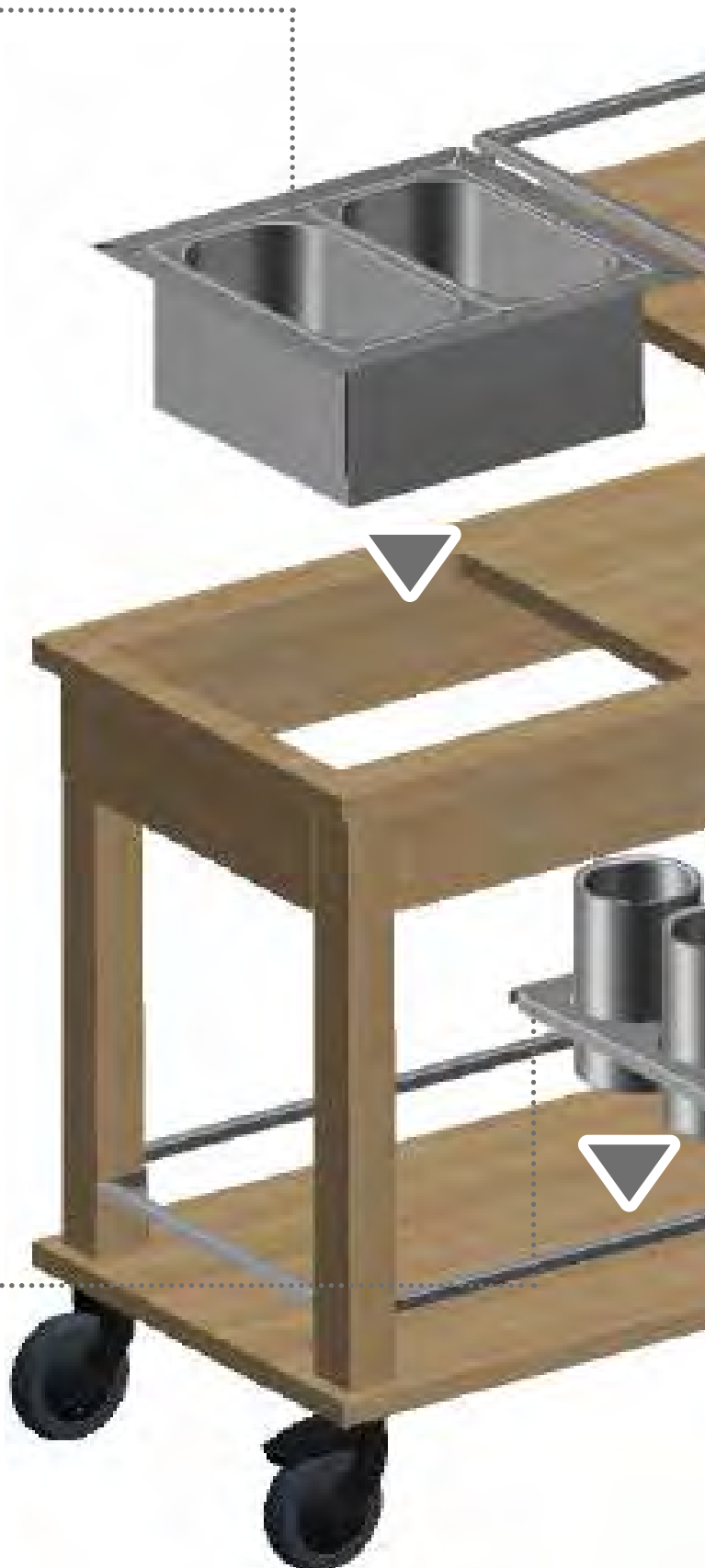
V42 05 51 004 46x17 h.1,6 Cm

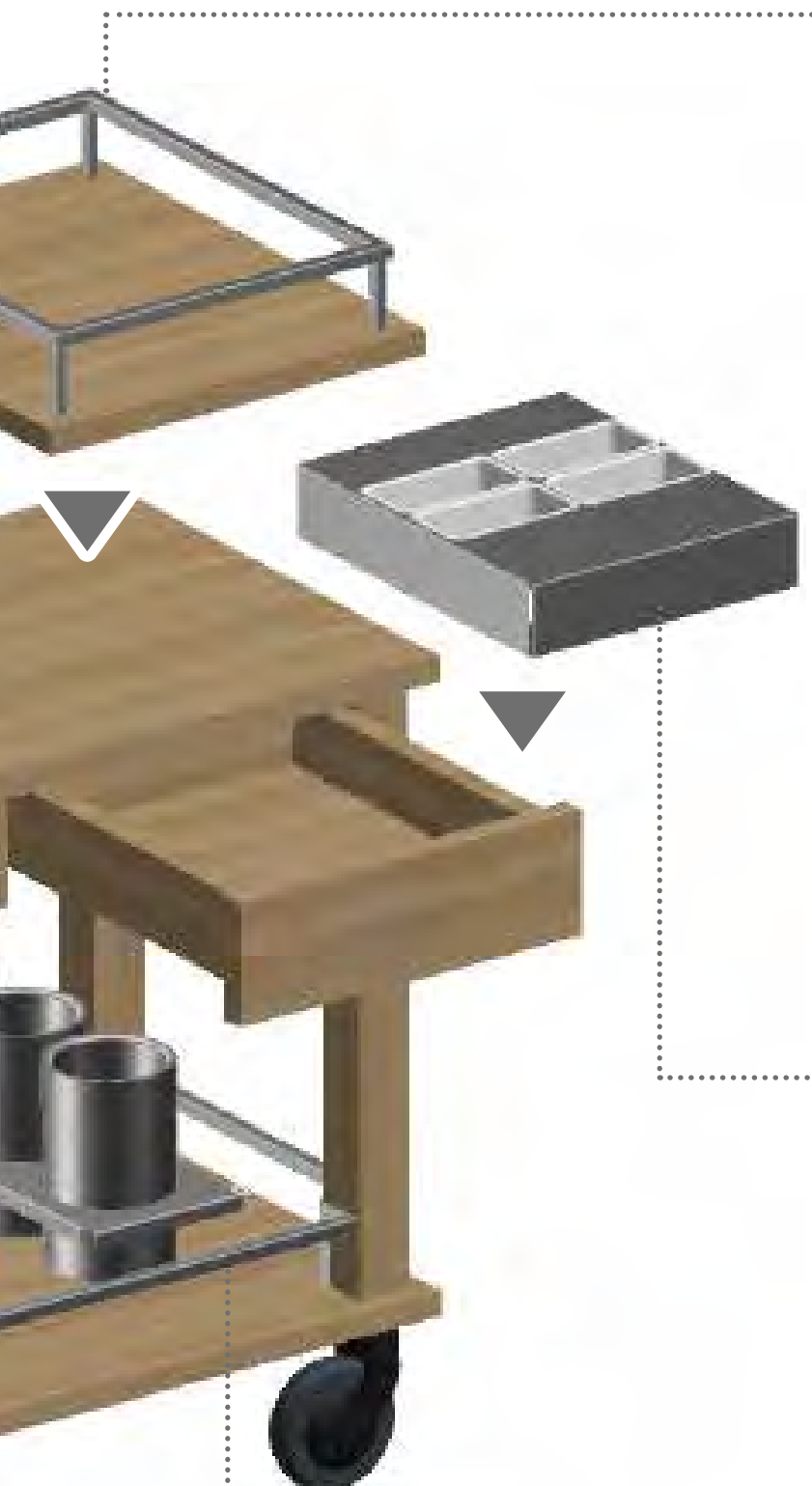

Top bar con ringhiera 41x50

Bar top with railing 41x50

Etagère bar a/barrière 41x50

Bandeja bar con barandilla 41x50

Bar-Top mit Umrandung, 41x50

V42 04 51 T01 41x50 h.10,5 Cm

V42 04 51 T02 41x50 h.10,5 Cm

Tagliere in legno

Wood cutting board

Planche à découper en bois

Tabla de cortar de madera

Holz Schneidebrett

V42 04 71 001 38x40 h.2 Cm

Accessori per cassetto

Drawer accessories

Porta portaposate

Cutlery-holder insert

Porte-couverts

Porta cubiertos

Besteckhalter-Einsatz

V42 04 94 001 36x29 h.7 Cm

Inserto portacondimenti

Condiment-holder insert

Porte-condiments

Porta condimentos

Condimenthalter-Einsatz

V42 05 51 005 36x29 h.7 Cm

Compenso poggia piatti

Dish tray

Support à assiettes

Bandeja para platos

Geschirr-Tablett

V42 04 42 001 29,5x25 h. 7 Cm

Ringhiera porta accessori

Accessory-holder railing

Barrière porte-accessoires

Barandilla porta accesorios

Accessoires-Halter mit Umrandung

V42 05 51 001 46x86 h.8 Cm

Carrello cocktail

Cocktail trolley
Chariot à cocktail
Carro cocktail
Cocktail-Wagen

	Cm	Colore / Color
 V42 04 51 011	90x50 h.90,5	Rovere chiaro / Light oak
 V42 04 51 012	90x50 h.90,5	Rovere scuro / Dark oak



Carrello arrosti

Roast-beef trolley
Chariot boeuf
Carro carne asada
Roastbeef-Wagen

	Cm	Colore / Color
 V42 04 51 009	90x50 h.90	Rovere chiaro / Light oak
 V42 04 51 010	90x50 h.90	Rovere scuro / Dark oak



Carrello Flambé ad induzione

Flambé trolley - induction

Chariot a flambé induction

Carro para flameado de inducción

Flambéwagen, Induktion

	Cm	Colore / Color
 V42 04 51 007	90x50 h.80	Rovere chiaro / Light oak
 V42 04 51 008	90x50 h.80	Rovere scuro / Dark oak





Carrello LUX multiuso

Universal trolley LUX

Chariot LUX multi-usages

Carro LUX multiuso



Servierwagen LUX

	Cm	Colore / Color
 V42 04 51 005	90x50 h.80	Rovere chiaro / Light oak
 V42 04 51 006	90x50 h.80	Rovere scuro / Dark oak



Top bar con ringhiera 90x50

Bar top with railing 90x50
 Etagère bar a/barrière 90x50
 Bandeja bar c/barandilla 90x50
 Bar-Top mit Umrandung 90x50

	Cm	Colore / Color
 V42 04 51 T03	90x50 h.10,5	Rovere chiaro / Light oak
 V42 04 51 T04	90x50 h.10,5	Rovere scuro / Dark oak

**Top dolci / formaggi refrigerato**

Dessert/cheese top, refrigerated
 Etagère dessert/fromages réfrigéré
 Bandeja postres/quesos refrigerado
 Dessert/Käse-Top; gekühlt

	Cm	Colore / Color
 V42 04 51 T05	90x50 h.28	Rovere chiaro / Light oak
 V42 04 51 T06	90x50 h.28	Rovere scuro / Dark oak

**Ringhiera porta accessori**

Accessory-holder railing
 Barrière porte-accessoires
 Barandilla porta accesorios
 Accessoires-Halter mit Umrandung

Inox 18/10 - St. Steel

	Cm
V42 05 51 001	46x86 h.8

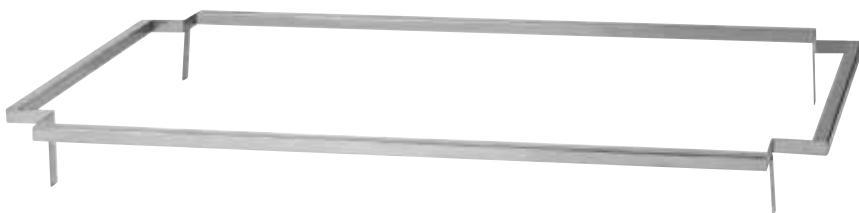

Piastra a induzione c/supporto inox 18/10

Induction plate + steel counter top 18/10 St. steel
 Plaque à induction a/support Acier 18/10
 Placa de inducción c/soporte Acero 18/10
 Induktionsplatte und Arbeitsplatte, Edelstahl 18/10

Cm
 V42 05 51 002 84x40,5 h.7

**Vasca ghiaccio Acciaio 18/10**

Ice pan/champagne bucket 18/10 St. Steel
 Bac à glace Acier 18/10
 Cubeta de hielo Acero 18/10
 Eispfanne / Champagnerkühler, Edelstahl 18/10

Inox 18/10 - St. Steel



Contenitore in acciaio per GN V42 05 51 006 43x40 h. 16
 Steel container for GN

Compatibile con
 Compatible with

1 x **GN 2/3** V01 05 72 G23D h. 15 Cm
 V01 05 15 G23 coperchio / lid

1 x **GN 1/3** V01 05 72 G13D h. 15 Cm
 V01 05 15 G13 coperchio / lid

**Top bar con ringhiera 41x50**

Bar top with railing 41x50
 Etagère bar a/barrière 41x50
 Bandeja bar con barandilla 41x50
 Bar-Top mit Umrandung, 41x50

Cm Colore / Color

 V42 04 51 T01 41x50 h.10,5 Rovere chiaro / Light oak

 V42 04 51 T02 41x50 h.10,5 Rovere scuro / Dark oak



Scaldavivande GN 2/3

Chafing dish GN 2/3

Chafing dish empotr GN 2/3

Chafing dish empotrable GN 2/3

Chafing-Dish GN 2/3

	Cm	H cm	
305 05 52 695	43 x 40	21	Coperchio in acciaio / St. Steel lid
305 05 52 694	43 x 40	21	Coperchio in vetro / Glass lid

**Piastra elettrica**

Heating element

Plaque électrique

Placa eléctrica

Heizelement für

V77 05 52 PCT
V77 05 52 PCT1

Con regolatore / With regulator

**Tagliere in legno**

Wood cutting board

Planche à découper en bois

Tabla de cortar de madera

Holz Schneidebrett

V42 04 71 001
38x40 h.2



Porta bottiglie / glacette

Bottle/bottle-cooler holder
 Porte-bouteilles/glacette
 Porta botellas/enfriador botellas
 Flaschen-/Flaschenkühlerhalter

Inox 18/10 - St. Steel

V42 05 51 003 Cm
 46x17 h.1,6

**Compatibile con**

Compatible with

3 x Glacette

Bottle coolers

V78 05 24 01 01 401

Ø12 h.17 Cm

**Porta sorbettiere**

Sherbet-pot holder
 Support sorbetières
 Porta sorbeteras
 Sorbet-Topf Stand

Inox 18/10 - St. Steel

V42 05 51 004 Cm
 46x17 h.1,6

**Compatibile con**

Compatible with

2 x Sorbettiere

Ice bucket

V78 05 20 00 11 401

Ø15 h.19,5 Cm



Porta portaposate

Cutlery-holder insert

Porte-couverts

Porta cubiertos

Besteckhalter-Einsatz

Legno multistrato - Multilayer wood

Cm

V42 04 94 001 36x29 h.7

**Inserto portaccondimenti**

Condiment-holder insert

Porte-condiments

Porta condimentos

Condimenthalter-Einsatz

Inox 18/10 / 18/10 st. steel - ABS

Cm

V42 05 51 005 36x29 h.7

**Compenso poggia piatti**

Dish tray

Support à assiettes

Bandeja para platos

Geschirr-Tablett

Legno multistrato - Multilayer wood

Cm

V42 04 42 001 29,5x25 h. 7



Cassetto estraibile con chiusura ammortizzata

Pull-out drawer with cushioned closing
Tiroir amovible avec fermeture en douceur
Cajón extraíble con cierre suave
Ausziehschublade mit sanftem Verschluss

**Gamba in legno massello e piani rivestiti i laminato**

Solid wood stand and tops, covered in laminate
Support en bois massif et étagères revêtues en laminé
Soporte de madera maciza y niveles revestidos en laminado
Massivholzständer und -platten mit Laminat bezogen

**Ruota pivotante antistatica con freno Ø 13 cm**

Anti-static pivoting wheel with brake, Ø 13 cm
Roue pivotante antistatique avec frein Ø 13 cm
Rueda pivotante antiestática con freno Ø 13 cm
Antistatisches Schwenkrad mit Bremse, Ø 13 cm



Carrello Basic

Basic trolley
Chariot Basic
Carro Basic
Basic-Wagen

	Cm	Colore / Color
■ V43 04 51 002	80x50 h.80	Rovere scuro / Dark oak

**Caratteristiche tecniche:**

- Gamba in acciaio inox 18/10
- Ruota pivotante ø13 Cm
- Piani rivestiti in laminato

Technical characteristics:

- Stainless steel stand
- Pivoting wheel, ø13 Cm
- Laminate covered tops

Carrello Basic

Basic trolley
Chariot Basic
Carro Basic
Basic-Wagen

	Cm	Colore / Color
 V43 04 51 001	80x50 h.80	Rovere chiaro / Light oak







MONDO CUCINA



Padella 1 manico

Frying pan, 1-handle
Poêle avec 1 manches
Mit Griff Pfanne
Sartén un mangos

Alluminio con fondo a induzione
Aluminium with induction bottom

	ø cm	ø in	H cm	H in
V67 11 72 PA24	24	9,1/2	6	2,3/8
V67 11 72 PA28	28	11	7	2,3/4
V67 11 72 PA32	32	12,5/8	7,5	3
V67 11 72 PA36	36	14,1/8	8	3,1/8
V67 11 72 PA40	40	15,3/4	8,5	3,3/8

**Pentola 2 manici**

Pot, 2-handle
Casserole avec 2 manches
Mit 2 Griffen Topf
Olla dos mangos

Alluminio con fondo a induzione
Aluminium with induction bottom

	ø cm	ø in	H cm	H in	lt	Oz
V67 11 72 PE28	28	11	15	6	8	270
V67 11 72 CA32	32	12,5/8	11,5	4,1/2	9	304

casseruola | casserole

**Tegame 2 manici**

Frying pan, 2-handle
Poêlon avec 2 manches
Mit 2 Griffen Flache Kochtopf
Olla dos mangos

Alluminio con fondo a induzione
Aluminium with induction bottom

	ø cm	ø in	H cm	H in
V67 11 72 TE24	24	9,1/2	6	2,3/8
V67 11 72 TE28	28	11	7	2,3/4
V67 11 72 TE32	32	12,5/8	7,5	3
V67 11 72 TE36	36	14,1/8	8	3,1/8
V67 11 72 TE40	40	15,3/4	8,5	3,3/8





COOK & SERVE

Il nuovo tegame Cook & Serve è una soluzione comoda e pratica. Ideale per la cottura degli alimenti grazie al fondo di 2mm e alla conducibilità dell'alluminio, che permette una diffusione uniforme del calore sull'intera superficie. Leggero, maneggevole ed elegante, diventa un accessorio perfetto anche per il servizio in tavola.

COOK & SERVE

The new pan Cook & Serve is a convenient and practical solution.

Ideal for cooking food, thanks to its 2-mm bottom and to aluminum conductivity, that allows a uniform heat diffusion on the whole surface.

Light, easy to handle and elegant, it becomes the perfect tool for the table service as well.



Tegame 2 manici

Saucepan, 2-handle

Faitout 2 anses

Sartén 2 asas

Topf, 2 Griffe

Alluminio / Aluminum

	Ø cm	H cm
V67 11 72 TP 16	16	4,5
V67 11 72 TP 18	18	4,5
V67 11 72 TP 20	20	4,5
V67 11 72 TP 22	22	4,5
V67 11 72 TP 24	24	4,5

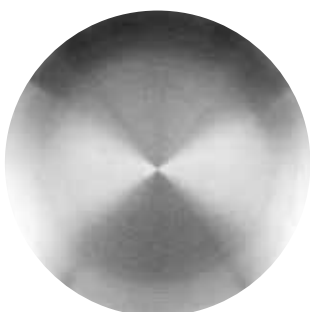

Wok antiaderente

Wok, non-stick
Wok anti-adhésif
Wok mit einem Griff
Wok antiadherente

Alluminio con fondo a induzione
Aluminium with induction bottom

	ø cm	ø in	H	Hin
V68 11 72 WO 26	26	10,1/4	7,8	3
V68 11 72 WO 28	28	11	7,8	3
V68 11 72 WO 30	30	11,3/4	8,8	3,1/2

**Casseruola 2 manici**

Casserole, 2-handle
Casserole à 2 manches
Kasserolle mit 2 Griffen
Cacerola 2 mangos

Alluminio con fondo a induzione
Aluminium with induction bottom

	ø cm	ø in	H cm	H in	lt
V68 11 72 CA 20A	20	7,7/8	8,8	3,1/2	2,8
V68 11 72 CA 22	22	8,5/8	9,2	3,1/2	3,5
V68 11 72 CA 24	24	9,1/2	10,7	4,1/8	4,8
V68 11 72 CA 26	26	10,1/4	11,8	4,3/4	6,2
V68 11 72 CA 28	28	11	12	4,3/4	7,4
V68 11 72 CA 32	32	12,5/8	12	4,3/4	9,5

**Casseruola 1 manico**

Casserole, 1-handle
Casserole à 1 manche
Kasserolle mit einem Griff
Cacerola 1 mango

Alluminio con fondo a induzione
Aluminium with induction bottom

	ø cm	ø in	H cm	H in	lt
V68 11 72 2CA 14	14	5,1/2	7	2,3/4	1
V68 11 72 2CA 16	16	6,1/4	8	3,1/8	1,6
V68 11 72 2CA 18	18	7	8,8	3,1/2	2,2
V68 11 72 2CA 20	20	7,7/8	8,8	3,1/2	2,8



Padella antiaderente 1 manico

Frying pan, non-stick 1-handle
 Poêle antiadhérente avec 1 manches
 Mit Griff Pfanne
 Sartén antiadherente un mangos

Alluminio con fondo a induzione
Aluminium with induction bottom

	ø cm	ø in	H cm	H in
V68 11 72 PA20	20	7,7/8	4,3	1,3/4
V68 11 72 PA22	22	8,5/8	4,3	1,3/4
V68 11 72 PA24	24	9,1/2	6	2,3/8
V68 11 72 PA28	28	11	7	2,3/4
V68 11 72 PA32	32	12,5/8	7,5	3
V68 11 72 PA36	36	14,1/8	8	3,1/8
V68 11 72 PA40	40	15,3/4	8,5	3,3/8



Pentola antiaderente 2 manici

Pot, non-stick 2-handle
 Casserole antiadhérente avec 2 manches
 Mit 2 Griffen Topf
 Olla antiadherente dos mangos

Alluminio con fondo a induzione
Aluminium with induction bottom

	ø cm	ø in	H cm	H in	lt	Oz
V68 11 72 PE28	28	11	15	6	8	270



Tegame antiaderente 2 manici

Pot, non stick 2 - handle
 Casserole antiadhérente avec 2 manches
 Mit 2 Griffen Flache Kochtopf
 Olla antiadherente dos mangos

Alluminio con fondo a induzione
Aluminium with induction bottom

	ø cm	ø in	H cm	H in
V68 11 72 TE24	24	9,1/2	6	2,3/8
V68 11 72 TE28	28	11	7	2,3/4
V68 11 72 TE32	32	12,5/8	7,5	3
V68 11 72 TE36	36	14,1/8	8	3,1/8
V68 11 72 TE40	40	15,3/4	8,5	3,3/8



Mestolo

Ladle
Louche
Suppenlöffel
Cazo

Nylon PA 6,6 FG 10%

	cm	in
● 903 12 81 C15 ME	32	12,5/8
● 903 12 81 C47 ME	32	12,5/8

**Schiumarola**

Skimmer
Ecumoire
Schaumlöffel
Espumadera

Nylon PA 6,6 FG 10%

	cm	in
● 903 12 81 C15 SC	35	13,3/4
● 903 12 81 C47 SC	35	13,3/4

**Pala fritto**

Frying shovel
Pelle à friture
Schaufel
Pala para freir

Nylon PA 6,6 FG 10%

	cm	in
● 903 12 81 C15 FR	35	13,3/4
● 903 12 81 C47 FR	35	13,3/4

**Paletta**

Showel
Pelle
Schaufel
Pala

Nylon PA 6,6 FG 10%

	cm	in
● 903 12 81 C15 PA1	35	13,3/4
● 903 12 81 C47 PA1	35	13,3/4

**Cucchiaine forato**

Slotted spoon
Cuillère à servir perforée
Gelochte Servierlöffel
Cucharòn perforado

Nylon PA 6,6 FG 10%

	cm	in
● 903 12 81 C15 CUF	35	13,3/4
● 903 12 81 C47 CUF	35	13,3/4

**Cucchiaine**

Serving spoon
Cuillère à servir
Servierlöffel
Cucharòn

Nylon PA 6,6 FG 10%

	cm	in
● 903 12 81 C15 CU	35	13,3/4
● 903 12 81 C47 CU	35	13,3/4



Servispaghetti

Spaghetti serving spoon
Louche à spaghetti
Servierlöffel für Spaghetti
Cucharón para spaghetti

Nylon PA 6,6 FG 10%

	cm	in
● 903 12 81 C15 SP	33,4	13,1/4
● 903 12 81 C47 SP	33,4	13,1/4



Paletta

Shovel
Pelle
Schaufel
Pala

Nylon PA 6,6 FG 10%

	cm	in
● 903 12 81 C15 PA2	32	12,5/8
● 903 12 81 C47 PA2	32	12,5/8



Paletta forata

Perforated shovel
Pelle perferèe
Gelochte Schaufel
Pala perforada

Nylon PA 6,6 FG 10%

	cm	in
● 903 12 81 C15 PAF	31,5	12,3/8
● 903 12 81 C47 PAF	31,5	12,3/8



Paletta fritto

Frying shovel
Pelle à friture
Schaufel
Pala para freir

Nylon PA 6,6 FG 10%

	cm	in
● 903 12 81 C15 PAA	32	12,5/8
● 903 12 81 C47 PAA	32	12,5/8



Pinza chef

Chef tongs
Pince chef
Chef Zange
Pinzas de chef

Nylon PA 6,6 FG 10%

	cm	in
● 903 12 81 C15 PI	30,5	12
● 903 12 81 C47 PI	30,5	12



Paletta scolatutto

Draining spoon
Cuillère à égoutter
Schaumschaufel
Cuchara para colar

Nylon PA 6,6 FG 10%

	cm	in
● 903 12 81 C15 PFG	38	15
● 903 12 81 C47 PFG	38	15



Molla toast/dolce

Toast/cake tongs

Pince à gâteaux

Kuchenschaufel

Pinzas postre

Nylon PA 6,6 FG 10%

	cm	in
● 903 12 81 C15 MD	28	11
● 903 12 81 C47 MD	28	11

**Molla insalata**

Salad tongs

Pince à salade

Salatschaufel

Pinzas ensalad

Nylon PA 6,6 FG 10%

	cm	in
● 903 12 81 C15 MI	31	12,1/4
● 903 12 81 C47 MI	31	12,1/4

**Molla spaghetti**

Spaghetti tongs

Pince à spaghetti

Spaghettizange

Pinzas spaghetti

Nylon PA 6,6 FG 10%

	cm	in
■ 903 12 81 C15 MS	31	11
■ 903 12 81 C47 MS	31	11

**Molla arrosto**

Roast tongs

Pince à rôti

Braten/Fleischzange

Pinzas asado

Nylon PA 6,6 FG 10%

	cm	in
■ 903 12 81 C15 MA	31	11
■ 903 12 81 C47 MA	31	11



Coltello chef

Chef knife
Couteau chef
Chefmesser
Cuchillo cocinero

Acciaio Inox - St. Steel + ABS

	cm	in
V67 06 91 001	15	6
V67 06 91 002	20	7,7/8
V67 06 91 025	23	9
V67 06 91 026	25	9,7/8

**Coltello pane**

Bread knife
Couteau pain
Brottmesser
Cuchillo pan

Acciaio Inox - St. Steel + ABS

	cm	in
V67 06 91 003	20	7,7/8

**Coltello affettare**

Slicing knife
Couteau pour coupe en tranches
Messer zum Aufschneiden
Cuchillo para filetear

Acciaio Inox - St. Steel + ABS

	cm	in
V67 06 91 004	20	7,7/8

**Coltello utility**

Utility knife
Couteau de service
Utility-Messer
Cuchillo universal

Acciaio Inox - St. Steel + ABS

	cm	in
V67 06 91 009	14	5,1/2

**Coltello santoku**

Santoku knife
Couteau Santoku
Santoku Profimesser
Cuchillo Santoku

Acciaio Inox - St. Steel + ABS

	cm	in
V67 06 91 005	12,5	5
V67 06 91 006	18	7

**Coltello disossare**

Boning knife
Couteau à désosser
Messer zum Entbeinen
Cuchillo deshuesador

Acciaio Inox - St. Steel + ABS

	cm	in
V67 06 91 007	16	6,1/4



Mannaretta

Cleaver
Couperet
Hackbeil Messer
Cuchillo de carnicero

Acciaio Inox - St. Steel + ABS

	cm	in
V67 06 91 027	18	7



Affilacoltelli professionale

Professional sharpener
Aiguiseur à couteaux
Schleifmittel
Afilador de cuchillos

Acciaio Inox - St. Steel + ABS

	cm	in
V67 06 91 012	20	7,7/8



Coltello professionale Utility

Professional Utility knife
Couteau de service dentelé
Utility-Messer
Cuchillo universal dentado

Acciaio Inox - St. Steel + ABS

	cm	in
V67 06 91 008	11,5	4,1/2



Coltello spelucchino

Paring knife
Couteau à éplucher
Schälmesser
Cuchillo guarnecer

Acciaio Inox - St. Steel + ABS

	cm	in
V67 06 91 010	8,8	3,1/2



Coltello professionale frutta

Professional fruit knife
Couteau à fruits
Obstmesser
Cuchillo frutas

Acciaio Inox - St. Steel + ABS

	cm	in
V67 06 91 011	8,8	3,1/2





Bastardella

Bowl
Bol
Edelstahl 18/10 Schale "Bastardella"
Bol

Acciaio Inox 18/10 - St. Steel 18/10

	ø cm	H cm	ø in	H in
V01 05 43 B 26	26	16,2	10,1/4	6,1/4
V01 05 43 B 22	22	16,2	8,5/8	6,1/4



Supporto per bastardella

Bowl stand
Support pour bol
Halter für Schale
Soparte para bol

Acciaio Inox 18/10 - St. Steel 18/10

	ø cm	H cm	ø in	H in
Z01 19 43 B 22	16	3	6,1/4	1,1/8



Ciotola Imperial

Bowl
Bol
Bol
Schale

Acciaio Inox 18/10 - St. Steel 18/10

	cm	in
V01 05 43 I16	16	6,1/4
V01 05 43 I18	18	7
V01 05 43 I20	20	7,7/8
V01 05 43 I22	22	8,5/8
V01 05 43 I24	24	9,1/2
V01 05 43 I28	28	11
V01 05 43 I32	32	12,5/8



Ciotola

Bowl
Bol
Bol
Schale

Acciaio Inox 18/10 - St. Steel 18/10

	ø cm	ø in	lt
AVARI 049	12	4,3/4	0,5
AVARI 052	16	6,1/4	1
AVARI 050	20	7,7/8	2
AVARI 053	23	9,8/8	3
AVARI 051	26	10,1/4	4
AVARI 054	29	11,1/2	5,5



Lasagnera

Lasagna tray
Plat à four
Lasagnepfanne
Lasañera

Acciaio Inox 18/10 - St. Steel 18/10

	cm	in
V03 06 26 026	26,5x19,5	10,3/8x7,5/8
V03 06 26 031	31,5x24	12,3/8x9,1/2
V03 06 26 037	37x27	14,1/2x10,5/8
V03 06 26 040	42x30,5	16,1/2x12







CUCINA • KITCHEN

I contenitori Gastronorm sono studiati e realizzati in conformità alla normativa UNI EN 631-1. Realizzati in AISI 304 (1.4301) per garantire un'ottima resistenza alla corrosione; l'AISI 304 è un acciaio austenitico che può essere utilizzato a contatto con gli alimenti secondo il decreto 11 Novembre 2013 Nr. 140.

Gastronorm containers are designed and manufactured in compliance with UNI EN 631-1 regulation. Made of AISI 304 (1.4301) to ensure an excellent corrosion resistance; AISI 304 is an austenitic steel that can be used in contact with food according to the Decree of 11 November 2013 No. 140.



Contentore GN 2/1**65x53 cm**

GN 2/1 container

Conteneur GN 2/1

GN Behälter Edelstahl Gn 2/1

Contenedor GN 2/1

Acciaio Inox 18/10 - St. Steel 18/10

	H cm	Sp. mm
V01 05 72 G21	2	0,7
V01 05 72 G21A	4	0,7
V01 05 72 G21B	6,5	0,7
V01 05 72 G21C	10	0,7
V01 05 72 G21D	15	0,7
V01 05 72 G21E	20	0,7

**Contentore GN 1/1****53x32,5 cm**

GN 1/1 container

Conteneur GN 1/1

GN Behälter Edelstahl Gn 1/1

Contenedor GN 1/1

Acciaio Inox 18/10 - St. Steel 18/10

	H cm	Sp. mm
V01 05 72 G11	2	0,7
V01 05 72 G11A	4	0,7
V01 05 72 G11B	6,5	0,7
V01 05 72 G11C	10	0,7
V01 05 72 G11D	15	0,7
V01 05 72 G11E	20	0,7

**Contentore GN 2/3****35,4x32,5 cm**

GN 2/3 container

Conteneur GN 2/3

GN Behälter Edelstahl Gn 2/3

Contenedor GN 2/3

Acciaio Inox 18/10 - St. Steel 18/10

	H cm	Sp. mm
V01 05 72 G23	2	0,7
V01 05 72 G23A	4	0,7
V01 05 72 G23B	6,5	0,7
V01 05 72 G23C	10	0,7
V01 05 72 G23D	15	0,7
V01 05 72 G23E	20	0,7



Contentore GN 1/2**32,5x26,5 cm**

GN 1/2 container
 Conteneur GN 1/2
 GN Behälter Edelstahl Gn 1/2
 Contenedor GN 1/2

Acciaio Inox 18/10 - St. Steel 18/10

	H cm	Sp. mm
V01 05 72 G12	2	0,7
V01 05 72 G12A	4	0,7
V01 05 72 G12B	6,5	0,7
V01 05 72 G12C	10	0,7
V01 05 72 G12D	15	0,7
V01 05 72 G12E	20	0,7

**Contentore GN 2/4****16,2x53 cm**

GN 2/4 container
 Conteneur GN2/4
 GN Behälter Edelstahl Gn 2/4
 Contenedor GN 2/4

Acciaio Inox 18/10 - St. Steel 18/10

	H cm	Sp. mm
V01 05 72 G24	2	0,7
V01 05 72 G24A	4	0,7
V01 05 72 G24B	6,5	0,7
V01 05 72 G24C	10	0,7
V01 05 72 G24D	15	0,7

**Contentore GN 1/3****32,5x17,6 cm**

GN 1/3 container
 Conteneur GN 1/3
 GN Behälter Edelstahl Gn 1/3
 Contenedor GN 1/3

Acciaio Inox 18/10 - St. Steel 18/10

	H cm	Sp. mm
V01 05 72 G13	2	0,7
V01 05 72 G13A	4	0,7
V01 05 72 G13B	6,5	0,7
V01 05 72 G13C	10	0,7
V01 05 72 G13D	15	0,7
V01 05 72 G13E	20	0,7



Contentitore GN 1/4**26,5x16,2 cm**

GN 1/4 container

Conteneur GN 1/4

GN Behälter Edelstahl Gn 1/4

Contenedor GN 1/4

Acciaio Inox 18/10 - St. Steel 18/10

	H cm	Sp. mm
V01 05 72 G14	2	0,7
V01 05 72 G14A	4	0,7
V01 05 72 G14B	6,5	0,7
V01 05 72 G14C	10	0,7
V01 05 72 G14D	15	0,7
V01 05 72 G14E	20	0,7

**Contentitore GN 1/6****17,6x16,2 cm**

GN 1/6 container

Conteneur GN 1/6

GN Behälter Edelstahl Gn 1/6

Contenedor GN 1/6

Acciaio Inox 18/10 - St. Steel 18/10

	H cm	Sp. mm
V01 05 72 G16	2	0,7
V01 05 72 G16A	4	0,7
V01 05 72 G16B	6,5	0,7
V01 05 72 G16C	10	0,7
V01 05 72 G16D	15	0,7
V01 05 72 G16E	20	0,7

**Contentitore GN 1/9****17,6x10,8 cm**

GN 1/9 container

Conteneur GN 1/9

GN Behälter Edelstahl Gn 1/9

Contenedor GN 1/9

Acciaio Inox 18/10 - St. Steel 18/10

	cm	H cm	Sp. mm
V01 05 72 G19A	4	0,7	
V01 05 72 G19B	6,5	0,7	
V01 05 72 G19C	10	0,7	



Separatore GN

GN adaptor bars
 GN Barrette de composition
 Separator GN
 Perfiles divisorios GN

Acciaio Inox 18/10 - St. Steel 18/10

	GN
V01 05 72 SE 11	1/1
V01 05 72 SE 12	1/2

**Falso fondo forato**

False perforated bottom
 Faux fond perforè
 Flascher Boden mit Löchern
 Falso hondo perforado

Acciaio Inox 18/10 - St. Steel 18/10

	GN
V01 05 72 FF 21	2/1
V01 05 72 FF 11	1/1
V01 05 72 FF 23	2/3
V01 05 72 FF 12	1/2

**Maniglia**

Handle
 Poignée
 Griff
 Manija

Acciaio Inox 18/10 - St. Steel 18/10

Z01 10 72 FIV	maniglia fissa verticale
Z01 10 72 RIE	maniglia rientrante

Teglia GN 2/1**65x53 cm**

2/1 GN baking pan

Plat à four GN 2/1

Gatronorm-Blech Edelstahl GN 2/1

Fuente para horno GN 2/1

Acciaio Inox 18/10 - St. Steel 18/10

	H cm	Sp. mm
V01 05 26 G21	2	0,7
V01 05 26 G21A	4	0,7
V01 05 26 G21B	6,5	0,7

**Teglia GN 1/1****53x32,5 cm**

1/1 GN baking pan

Plat à four GN 1/1

Gatronorm-Blech Edelstahl GN 1/1

Fuente para horno GN 1/1

Acciaio Inox 18/10 - St. Steel 18/10

	H cm	Sp. mm
V01 05 26 G110	1	0,7
V01 05 26 G11	2	0,7
V01 05 26 G11A	4	0,7
V01 05 26 G11B	6,5	0,7

**Teglia GN 1/2****32,5x26,5 cm**

1/2 GN baking pan

Plat à four GN 1/2

Gatronorm-Blech Edelstahl GN 1/2

Fuente para horno GN 1/2

Acciaio Inox 18/10 - St. Steel 18/10

	H cm	Sp. mm
V01 05 26 G12	2	0,7
V01 05 26 G12A	4	0,7
V01 05 26 G12B	6,5	0,7

**Teglia GN 2/3****35,4x32,5 cm**

2/3 GN baking pan

Plat à four GN 2/3

Gatronorm-Blech Edelstahl GN 2/3

Fuente para horno GN 2/3

Acciaio Inox 18/10 - St. Steel 18/10

	H cm	Sp. mm
V01 05 26 G23	2	0,7
V01 05 26 G23A	4	0,7
V01 05 26 G23B	6,5	0,7



Coperchio GN

GN lid
Couvercle GN
GN Deckel
Tapa GN

Acciaio Inox 18/10 - St. Steel 18/10

	GN	cm	Sp. mm
V01 05 15 G11	1/1	53x32,5	0,7
V01 05 15 G23	2/3	35,4x32,5	0,7
V01 05 15 G12	1/2	32,5x26,5	0,7
V01 05 15 G13	1/3	32,5x17,6	0,7
V01 05 15 G14	1/4	26,5x16,2	0,7
V01 05 15 G16	1/6	17,6x16,2	0,7
V01 05 15 G19	1/9	17,6x10,8	0,7
V01 05 15 G24	2/4	16,2x53	0,7

**Con asola/with hole**

	GN	cm	Sp. mm
V01 05 15 GM11	1/1	53x32,5	0,7
V01 05 15 GM12	1/2	32,5x26,5	0,7
V01 05 15 GM13	1/3	32,5x17,6	0,7
V01 05 15 GM14	1/4	26,5x16,2	0,7
V01 05 15 GM16	1/6	17,6x16,2	0,7
V01 05 15 GM19	1/9	17,6x10,8	0,7
V01 05 15 GM23	2/3	35,4x32,5	0,7
V01 05 15 GM24	2/4	16,2x53	0,7

**Cooperchio con guarnizione in silicone**

	GN	cm	Sp. mm
V010515GG11	1/1	53x32,5	0,7
V010515GG23	2/3	35,4x32,5	0,7
V010515GG12	1/2	32,5x26,5	0,7
V010515GG13	1/3	32,5x17,6	0,7
V010515GG14	1/4	26,5x16,2	0,7
V010515GG16	1/6	17,6x16,2	0,7



Vaschetta gelato GN

GN ice cream pan

Bac à glace GN

Eisschale GN

Cubeta helado GN

Acciaio Inox 18/10 - St. Steel 18/10

	cm	H cm
V01 05 72 IO 412	16,5x36	12

Bacinella forata (fondo + lati)

Perforated basin (bottom + sides)

Bacs perforè (fond + côtés)

Schüssel mit Löchern (Boden + Seiten)

Bandejas honda perforada (fondo y lados)

Acciaio Inox 18/10 - St. Steel 18/10

	H cm	H in	GN
V01 05 72 GF 11BL	6,5	2,1/2	1/1
V01 05 72 GF 11C	10	4	1/1
V01 05 72 GF 11D	15	6	1/1
V01 05 72 GF 11E	20	7,7/8	1/1
V01 05 72 GF 12C	10	4	1/2
V01 05 72 GF 12D	15	6	1/2
V01 05 72 GF 12E	20	7,7/8	1/2

**Bacinella forata (solo fondo)**

Perforated basin (bottom only)

Bacs perforè (fond seulement)

Schüssel mit Löchern (nur Boden)

Bandejas honda perforada (solo el fondo)

Acciaio Inox 18/10 - St. Steel 18/10

	H cm	H in	GN
V01 05 72 GF 21	2	0,3/4	2/1
V01 05 72 GF 21A	4	1,1/2	2/1
V01 05 72 GF 21B	6,5	2,1/2	2/1
01 05 72 GF 11	2	0,3/4	1/1
V01 05 72 GF 11A	4	1,1/2	1/1
V01 05 72 GF 11B	6,5	2,1/2	1/1
V01 05 72 GF 12	2	0,3/4	1/2
V01 05 72 GF 12A	4	1,1/2	1/2
V01 05 72 GF 12B	6,5	2,1/2	1/2
V01 05 72 GF 13	2	0,3/4	1/3
V01 05 72 GF 13A	4	1,1/2	1/3
V01 05 72 GF 13B	6,5	2,1/2	1/3
V01 05 72 GF 23	2	0,3/4	2/3
V01 05 72 GF 23A	4	1,1/2	2/3
V01 05 72 GF 23B	6,5	2,1/2	2/3



Contenitore GN 2/1

GN 2/1 container
 Conteneur GN 2/1
 GN Behälter GN 2/1
 Contenedor GN 2/1

Policarbonato - Polycarbonate

	cm	H cm
V01 PC 72 G11 E	65x53	20

**Contenitore GN 1/1**

GN 1/1 container
 Conteneur GN 1/1
 GN Behälter GN 1/1
 Contenedor GN 1/1

Policarbonato - Polycarbonate

	cm	H cm
V01 PC 72 G11 B	53x32,5	6,5
V01 PC 72 G11 C	53x32,5	10
V01 PC 72 G11 D	53x32,5	15
V01 PC 72 G11 E	53x32,5	20

**Contenitore GN 1/2**

GN 1/2 container
 Conteneur GN 1/2
 GN Behälter GN 1/2
 Contenedor GN 1/2

Policarbonato - Polycarbonate

	cm	H cm
V01 PC 72 G12 B	32,5x26,5	6,5
V01 PC 72 G12 C	32,5x26,5	10
V01 PC 72 G12 D	32,5x26,5	15
V01 PC 72 G12 E	32,5x26,5	20

**Contenitore GN 1/3**

GN 1/3 container
 Conteneur GN 1/3
 GN Behälter GN 1/3
 Contenedor GN 1/3

Policarbonato - Polycarbonate

	cm	H cm
V01 PC 72 G13 B	32,5x17,6	6,5
V01 PC 72 G13 C	32,5x17,6	10
V01 PC 72 G13 D	32,5x17,6	15
V01 PC 72 G13 E	32,5x17,6	20



Contentitore GN 1/4

GN 1/4 container
 Conteneur GN 1/4
 GN Behälter GN 1/4
 Contenedor GN 1/4

Policarbonato - Polycarbonate

	cm	H cm
V01 PC 72 G14 B	26,5x16,2	6,5
V01 PC 72 G14 C	26,5x16,2	10
V01 PC 72 G14 D	26,5x16,2	15
V01 PC 72 G14 E	26,5x16,2	20

**Contentitore GN 1/6**

GN 1/6 container
 Conteneur GN 1/6
 GN Behälter GN 1/6
 Contenedor GN 1/6

Policarbonato - Polycarbonate

	cm	H cm
V01 PC 72 G16 B	17,6x16,2	6,5
V01 PC 72 G16 C	17,6x16,2	10
V01 PC 72 G16 D	17,6x16,2	15
V01 PC 72 G16 E	17,6x16,2	20

**Contentitore GN 1/9**

GN 1/9 container
 Conteneur GN 1/9
 GN Behälter GN 1/9
 Contenedor GN 1/9

Policarbonato - Polycarbonate

	cm	H cm
V01 PC 72 G19 B	17,6x10,8	6,5
V01 PC 72 G19 C	17,6x10,8	10

**Vaschetta gelato GN**

GN ice cream pan
 Bac à glace GN
 Eisschale GN
 Cubeta helado GN

Policarbonato - Polycarbonate

	cm	H cm
V01 PC 72 GGE	16,5x36	12



Coperchio

Lid
Couvercle
Deckel
Tapa

Policarbonato - Polycarbonate

	cm	GN
V01 PC 15 G21	65x53	2/1
V01 PC 15 G11	53x32,5	1/1
V01 PC 15 G12	32,5x26,5	1/2
V01 PC 15 G13	32,5x17,6	1/3
V01 PC 15 G14	26,5x16,2	1/4
V01 PC 15 G16	17,6x16,2	1/6
V01 PC 15 G19	17,6x10,8	1/9

**Coperchio GN ermetico**

GN hermetic lid
Couvercle hermétique GN
Hermetische Deckel GN
Tapa GN hermética

Policarbonato - Polycarbonate

	GN	cm
V01 PC 15 GE11	1/1	53x32,5
V01 PC 15 GE12	1/2	32,5x26,5
V01 PC 15 GE13	1/3	32,5x17,6
V01 PC 15 GE14	1/4	26,5x16,2
V01 PC 15 GE16	1/6	17,6x16,2
V01 PC 15 GE19	1/9	17,6x10,8

**Coperchio**

Lid
Couvercle
Deckel
Tapa

Polipropilene - Polypropylene

	cm	GN
V01 PP 15 G11	53x32,5	1/1
V01 PP 15 G12	32,5x26,5	1/2
V01 PP 15 G13	32,5x17,6	1/3
V01 PP 15 G14	26,5x16,2	1/4
V01 PP 15 G16	17,6x16,2	1/6
V01 PP 15 G19	17,6x10,8	1/9



Contentore GN 1/1

GN 1/1 container
 Conteneur GN 1/1
 GN Behälter Gn 1/1
 Contenedor GN 1/1

Polipropilene - Polypropylene

	cm	H cm
V01 PP 72 G11 B	53x32,5	6,5
V01 PP 72 G11 C	53x32,5	10
V01 PP 72 G11 D	53x32,5	15
V01 PP 72 G11 E	53x32,5	20

**Contentore GN 1/2**

GN 1/2 container
 Conteneur GN 1/2
 GN Behälter Gn 1/2
 Contenedor GN 1/2

Polipropilene - Polypropylene

	cm	H cm
V01 PP 72 G12 B	32,5x26,5	6,5
V01 PP 72 G12 C	32,5x26,5	10
V01 PP 72 G12 D	32,5x26,5	15
V01 PP 72 G12 E	32,5x26,5	20

**Contentore GN 1/3**

GN 1/3 container
 Conteneur GN 1/3
 GN Behälter Gn 1/3
 Contenedor GN 1/3

Polipropilene - Polypropylene

	cm	H cm
V01 PP 72 G13 B	32,5x17,6	6,5
V01 PP 72 G13 C	32,5x17,6	10
V01 PP 72 G13 D	32,5x17,6	15
V01 PP 72 G13 E	32,5x17,6	20

**Contentore GN 1/4**

GN 1/4 container
 Conteneur GN 1/4
 GN Behälter Gn 1/4
 Contenedor GN 1/4

Polipropilene - Polypropylene

	cm	H cm
V01 PP 72 G14 B	26,5x16,2	6,5
V01 PP 72 G14 C	26,5x16,2	10
V01 PP 72 G14 D	26,5x16,2	15
V01 PP 72 G14 E	26,5x16,2	20



Contentitore GN 1/6

GN 1/6 container
 Conteneur GN 1/6
 GN Behälter Gn 1/6
 Contenedor GN 1/6

Polipropilene - Polypropylene

	cm	H cm
V01 PP 72 G16 B	17,6x16,2	6,5
V01 PP 72 G16 C	17,6x16,2	10
V01 PP 72 G16 D	17,6x16,2	15
V01 PP 72 G16 E	17,6x16,2	20

**Contentitore GN 1/9**

GN 1/9 container
 Conteneur GN 1/9
 GN Behälter Gn 1/9
 Contenedor GN 1/9

Polipropilene - Polypropylene

	cm	H cm
V01 PP 72 G19 B	17,6x10,8	6,5
V01 PP 72 G19 C	17,6x10,8	10

**Vaschetta gelato GN**

GN ice cream pan
 Bac à glace GN
 Eisschale, übereinander legbar
 Cubeta helado GN

Polipropilene - Polypropylene

	cm	H cm
V01 PP 72 GGE	16,5x36	12

**Falso fondo forato**

False perforated bottom
 Faux fond perforé
 Flascher Boden mit Löchern
 Falso hondo perforado

Polipropilene - Polypropylene

	GN
V01 PP 72 FF11	1/1
V01 PP 72 FF12	1/2
V01 PP 72 FF13	1/3
V01 PP 72 FF16	1/6

Carapina Professionale

Ice cream professional container
 Conteneur à glace professionnel
 Contenedor helado profesional
 Eis Behälter, profi

Acciaio Inox - St. Steel

	ø cm	H cm	ø in	H in
V01 05 72 GGE	20	23,5	7,7/8	9,1/4

**Spillone pizzeria**

Pizza pin
 Epingle pour commandes pizzeria
 Pizzeria Stecknadel
 Agujón para hojas pedidos pizzeria

Acciaio Inox - St. Steel

AVARI 086

**Campanello reception**

Reception bell
 Sonette de réception
 Hotelglocke
 Timbre recepción

Acciaio Inox - St. Steel

AVARI 112

**Trinciapollo manico pom rivettato**

Shears, pom riveted handle
 Ciseaux à volailles manche POM riveté
 Geflügel Schere mit genietetem Heft
 Tijeras para aves mango pom remachado

Acciaio Inox - St. Steel

AVARI 110

**Trinciapollo manico cavo**

Shears, hollow handle
 Tijeras para aves mango hueco
 Geflügel Schere mit hohem Heft
 Ciseaux à volailles manche creuse

Acciaio Inox AISI 420

AVARI 111



Schiumarola unipezzo

Skimmer, one piece
 Ecumoire en une pièce
 Schaumlöffel einteilig
 Espumadera de una sola pieza

Acciaio Inox - St. Steel

	ø cm	ø in
903 06 81 US1	11	4,3/8
903 06 81 US3	13	5,1/8



Mestolo unipezzo

Soup, one piece
 Louche en une pièce
 Schopflöffel einteilig
 Cazo sopa de una sola pieza

Acciaio Inox - St. Steel

	ø cm	ø in
903 06 81 UM9	9	3,1/2
903 06 81 UM1	10	4



Mestolino unipezzo

Sauce ladle, one piece
 Louche à sauce en une pièce
 Schopflöffel klein einteilig
 Cacillo salsa de una sola pieza

Acciaio Inox - St. Steel

	L cm	L in
903 06 81 UMS	28	11



Pala fritto unipezzo

Frying palette, one piece
 Pelle frittura en une pièce
 Schaufel einteilig
 Pala frito de una sola pieza

Acciaio Inox - St. Steel

	L cm	L in
903 06 81 UFR	36,5	14,3/8



Cucchiaione unipezzo

Serving spoon, one piece
 Cuillère à servir en une pièce
 Löffel einteilig
 Cucharón servir de una sola pieza

Acciaio Inox - St. Steel

	L cm	L in
903 06 81 UCU	40	15,3/4



Forchettone unipezzo

Serving fork, one piece
 Fourchette à servir en une pièce
 Gabel einteilig
 Tenedor servir de una sola pieza

Acciaio Inox - St. Steel

	L cm	L in
903 06 81 UFO	36	14,1/8





abert

ABERT S.p.A.

Via Don P. Mazzolari, 17
25050 Passirano (Bs) Italy
T. 0306853611
F. 0306577194

info@abert.it
www.abert.it

HO.RE.CA.

20
21

abert